

2026

borled®

AYDINLATMA ÜRÜNLERİ KATALOĞU - LIGHTING PRODUCTS CATALOG

AYDINLATMA ÜRÜNLERİ KATALOĞU

LIGHTING
PRODUCTS CATALOG

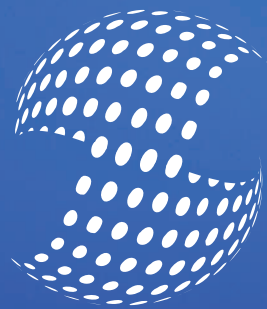

borled®
by **borsan**

2026



Ürün Kodu	Ürün Açıklaması	Sayfa No
BL-E1-0015-RS-3H	LED ETANJ LEVEL 30W 1200MM (RADAR SENS. + 3H ACIL KİT 6500K) GRI	28
BLT-E1-0009	LED ETANJ LEVEL 15W 600MM (4000K) GRI TSE	28
BLT-E1-0013	LED ETANJ LEVEL 15W 600MM (6500K) GRI TSE	28
BLT-E1-0009-RS	LED ETANJ LEVEL 15W 600MM (RADAR SENS. 4000K) GRI TSE	28
BLT-E1-0013-RS	LED ETANJ LEVEL 15W 600MM (RADAR SENS. 6500K) GRI TSE	28
BLT-E1-0009-3H	LED ETANJ LEVEL 15W 600MM (3H ACIL KİTLİ 4000K) GRI TSE	28
BLT-E1-0013-3H	LED ETANJ LEVEL 15W 600MM (3H ACIL KİTLİ 6500K) GRI TSE	28
BLT-E1-0009-RS-3H	LED ETANJ LEVEL 15W 600MM (RADAR SENS. + 3H ACIL KİT 4000K) GRI TSE	28
BLT-E1-0013-RS-3H	LED ETANJ LEVEL 15W 600MM (RADAR SENS. + 3H ACIL KİT 6500K) GRI TSE	28
BLT-E1-0011	LED ETANJ LEVEL 30W 1200MM (4000K) GRI TSE	28
BLT-E1-0015	LED ETANJ LEVEL 30W 1200MM (6500K) GRI TSE	28
BLT-E1-0011-RS	LED ETANJ LEVEL 30W 1200MM (RADAR SENS. 4000K) GRI TSE	28
BLT-E1-0015-RS	LED ETANJ LEVEL 30W 1200MM (RADAR SENS. 6500K) GRI TSE	28
BLT-E1-0011-3H	LED ETANJ LEVEL 30W 1200MM (3H ACIL KİTLİ 4000K) GRI TSE	28
BLT-E1-0015-3H	LED ETANJ LEVEL 30W 1200MM (3H ACIL KİTLİ 6500K) GRI TSE	28
BLT-E1-0011-RS-3H	LED ETANJ LEVEL 30W 1200MM (RADAR SENS. + 3H ACIL KİT 4000K) GRI TSE	28
BLT-E1-0015-RS-3H	LED ETANJ LEVEL 30W 1200MM (RADAR SENS. + 3H ACIL KİT 6500K) GRI TSE	28
BL-E1-0010	LED ETANJ ELİPS 20W 600MM (4000K) GRI	29
BL-E1-0014	LED ETANJ ELİPS 20W 600MM (6500K) GRI	29
BL-E1-0010-RS	LED ETANJ ELİPS 20W 600MM (RADAR SENS. 4000K) GRI	29
BL-E1-0014-RS	LED ETANJ ELİPS 20W 600MM (RADAR SENS. 6500K) GRI	29
BL-E1-0010-3H	LED ETANJ ELİPS 20W 600MM (3H ACIL KİTLİ 4000K) GRI	29
BL-E1-0014-3H	LED ETANJ ELİPS 20W 600MM (3H ACIL KİTLİ 6500K) GRI	29
BL-E1-0010-RS-3H	LED ETANJ ELİPS 20W 600MM (RADAR SENS. + 3H ACIL KİT 4000K) GRI	29
BL-E1-0014-RS-3H	LED ETANJ ELİPS 20W 600MM (RADAR SENS. + 3H ACIL KİT 6500K) GRI	29
BL-E1-0012	LED ETANJ ELİPS 40W 1200MM (4000K) GRI	29
BL-E1-0016	LED ETANJ ELİPS 40W 1200MM (6500K) GRI	29
BL-E1-0012-RS	LED ETANJ ELİPS 40W 1200MM (RADAR SENS. 4000K) GRI	29
BL-E1-0016-RS	LED ETANJ ELİPS 40W 1200MM (RADAR SENS. 6500K) GRI	29
BL-E1-0012-3H	LED ETANJ ELİPS 40W 1200MM (3H ACIL KİTLİ 4000K) GRI	29
BL-E1-0016-3H	LED ETANJ ELİPS 40W 1200MM (3H ACIL KİTLİ 6500K) GRI	29
BL-E1-0012-RS-3H	LED ETANJ ELİPS 40W 1200MM (RADAR SENS. + 3H ACIL KİT 4000K) GRI	29
BL-E1-0016-RS-3H	LED ETANJ ELİPS 40W 1200MM (RADAR SENS. + 3H ACIL KİT 6500K) GRI	29
BLT-E1-0010	LED ETANJ ELİPS 20W 600MM (4000K) GRI TSE	29
BLT-E1-0014	LED ETANJ ELİPS 20W 600MM (6500K) GRI TSE	29
BLT-E1-0010-RS	LED ETANJ ELİPS 20W 600MM (RADAR SENS. 4000K) GRI TSE	29
BLT-E1-0014-RS	LED ETANJ ELİPS 20W 600MM (RADAR SENS. 6500K) GRI TSE	29
BLT-E1-0010-3H	LED ETANJ ELİPS 20W 600MM (3H ACIL KİTLİ 4000K) GRI TSE	29
BLT-E1-0014-3H	LED ETANJ ELİPS 20W 600MM (3H ACIL KİTLİ 6500K) GRI TSE	29
BLT-E1-0010-RS-3H	LED ETANJ ELİPS 20W 600MM (RADAR SENS. + 3H ACIL KİT 4000K) GRI TSE	29
BLT-E1-0014-RS-3H	LED ETANJ ELİPS 20W 600MM (RADAR SENS. + 3H ACIL KİT 6500K) GRI TSE	29
BLT-E1-0012	LED ETANJ ELİPS 40W 1200MM (4000K) GRI TSE	29
BLT-E1-0016	LED ETANJ ELİPS 40W 1200MM (6500K) GRI TSE	29
BLT-E1-0012-RS	LED ETANJ ELİPS 40W 1200MM (RADAR SENS. 4000K) GRI TSE	29
BLT-E1-0016-RS	LED ETANJ ELİPS 40W 1200MM (RADAR SENS. 6500K) GRI TSE	29
BLT-E1-0012-3H	LED ETANJ ELİPS 40W 1200MM (3H ACIL KİTLİ 4000K) GRI TSE	29
BLT-E1-0016-3H	LED ETANJ ELİPS 40W 1200MM (3H ACIL KİTLİ 6500K) GRI TSE	29
BLT-E1-0012-RS-3H	LED ETANJ ELİPS 40W 1200MM (RADAR SENS. + 3H ACIL KİT 4000K) GRI TSE	29
BLT-E1-0016-RS-3H	LED ETANJ ELİPS 40W 1200MM (RADAR SENS. + 3H ACIL KİT 6500K) GRI TSE	29
BL-EE-0001	LYRA ETANJ 600MM 20W 6500K	30
BL-EE-0002	LYRA ETANJ 600MM 20W 4000K	30
BL-EE-0003	LYRA ETANJ 600MM 20W 3000K	30
BL-EE-0004	LYRA ETANJ 1200MM 40W 3000K	30
BL-EE-0005	LYRA ETANJ 1200MM 40W 4000K	30
BL-EE-0006	LYRA ETANJ 1200MM 40W 6500K	30
BL-ME-0001	MİD ETANJ 600MM 20W 6500K	30
BL-ME-0002	MİD ETANJ 600MM 20W 4000K	30
BL-ME-0003	MİD ETANJ 600MM 20W 3000K	30
BL-ME-0004	MİD ETANJ 1200MM 40W 6500K	30
BL-ME-0005	MİD ETANJ 1200MM 40W 4000K	30

Ürün Kodu	Ürün Açıklaması	Sayfa No
BL-ME-0006	MİD ETANJ 1200MM 40W 3000K	30
BL-KE-0001	KOŞE ETANJ 600MM 20W 6500K	30
BL-KE-0002	KOŞE ETANJ 600MM 20W 4000K	30
BL-KE-0003	KOŞE ETANJ 600MM 20W 3000K	30
BL-KE-0004	KOŞE ETANJ 1200MM 40W 3000K	30
BL-KE-0005	KOŞE ETANJ 1200MM 40W 4000K	30
BL-KE-0006	KOŞE ETANJ 1200MM 40W 6500K	30
BL-PE-0001	PREMIUM ETANJ 600MM 40W 6500K	30
BL-PE-0002	PREMIUM ETANJ 600MM 40W 4000K	30
BL-PE-0003	PREMIUM ETANJ 600MM 40W 3000K	30
BL-PE-0004	PREMIUM ETANJ 1200MM 60W 6500K	30
BL-PE-0005	PREMIUM ETANJ 1200MM 60W 4000K	30
BL-PE-0006	PREMIUM ETANJ 1200MM 60W 3000K	30
BL-PE-0007	PREMIUM ETANJ 1200MM 80W 3000K	30
BL-PE-0008	PREMIUM ETANJ 1200MM 80W 4000K	30
BL-PE-0009	PREMIUM ETANJ 1200MM 80W 6500K	30
BL-TB-0001	T5 LED TUBE ARMATÜR 4W 6500K (EKLEN-EBİLİR)	31
BL-TB-0002	T5 LED TUBE ARMATÜR 4W 4000K (EKLEN-EBİLİR)	31
BL-TB-0003	T5 LED TUBE ARMATÜR 4W 3000K (EKLEN-EBİLİR)	31
BL-TB-0004	T5 LED TUBE ARMATÜR 8W 6500K (EKLEN-EBİLİR)	31
BL-TB-0005	T5 LED TUBE ARMATÜR 8W 4000K (EKLEN-EBİLİR)	31
BL-TB-0006	T5 LED TUBE ARMATÜR 8W 3000K (EKLEN-EBİLİR)	31
BL-TB-0007	T5 LED TUBE ARMATÜR 12W 6500K (EKLEN-EBİLİR)	31
BL-TB-0008	T5 LED TUBE ARMATÜR 12W 4000K (EKLEN-EBİLİR)	31
BL-TB-0009	T5 LED TUBE ARMATÜR 12W 3000K (EKLEN-EBİLİR)	31
BL-TB-0010	T5 LED TUBE ARMATÜR 16W 6500K (EKLEN-EBİLİR)	31
BL-TB-0011	T5 LED TUBE ARMATÜR 16W 4000K (EKLEN-EBİLİR)	31
BL-TB-0012	T5 LED TUBE ARMATÜR 16W 3000K (EKLEN-EBİLİR)	31
BL-KB-0001	80W KRİSTAL BANT ARMATÜR 3000K	32
BL-KB-0002	80W KRİSTAL BANT ARMATÜR 4000K	32
BL-KB-0003	80W KRİSTAL BANT ARMATÜR 6500K	32
BL-KB-0004	100W KRİSTAL BANT ARMATÜR 3000K	32
BL-KB-0005	100W KRİSTAL BANT ARMATÜR 4000K	32
BL-KB-0006	100W KRİSTAL BANT ARMATÜR 6500K	32
BL-KB-0001-S	80W KRİSTAL BANT ARMATÜR 3000K SİYAH	32
BL-KB-0002-S	80W KRİSTAL BANT ARMATÜR 4000K SİYAH	32
BL-KB-0003-S	80W KRİSTAL BANT ARMATÜR 6500K SİYAH	32
BL-KB-0004-S	100W KRİSTAL BANT ARMATÜR 3000K SİYAH	32
BL-KB-0005-S	100W KRİSTAL BANT ARMATÜR 4000K SİYAH	32
BL-KB-0006-S	100W KRİSTAL BANT ARMATÜR 6500K SİYAH	32
BL-P4-0001	LED PROJİKTÖR 10W 3000K GOLD SERİSİ (SHUN.)	34
BL-P4-0003	LED PROJİKTÖR 10W 6500K GOLD SERİSİ (SHUN.)	34
BL-P4-0004	LED PROJİKTÖR 20W 3000K GOLD SERİSİ (SHUN.)	34
BL-P4-0006	LED PROJİKTÖR 20W 6500K GOLD SERİSİ (SHUN.)	34
BL-P4-0007	LED PROJİKTÖR 30W 3000K GOLD SERİSİ (SHUN.)	34
BL-P4-0009	LED PROJİKTÖR 30W 6500K GOLD SERİSİ (SHUN.)	34
BL-P4-0010	LED PROJİKTÖR 50W 3000K GOLD SERİSİ (SHUN.)	34
BL-P4-0012	LED PROJİKTÖR 50W 6500K GOLD SERİSİ (SHUN.)	34
BL-P4-50GRN	LED PROJİKTÖR 50W YEŞİL GOLD SERİSİ (SHUNDE)	34
BL-P4-0013	LED PROJİKTÖR 70W 3000K GOLD SERİSİ (SHUN.)	34
BL-P4-0015	LED PROJİKTÖR 70W 6500K GOLD SERİSİ (SHUN.)	34
BL-P4-0016	LED PROJİKTÖR 100W 3000K GOLD SERİSİ (SHUN.)	34
BL-P4-0018	LED PROJİKTÖR 100W 6500K GOLD SERİSİ (SHUN.)	34
BL-P4-100GRN	LED PROJİKTÖR 100W YEŞİL GOLD SERİSİ (SHUNDE)	34
BL-P4-0019	LED PROJİKTÖR 150W 3000K GOLD SERİSİ (SHUN.)	34
BL-P4-0021	LED PROJİKTÖR 150W 6500K GOLD SERİSİ (SHUN.)	34
BL-P4-0022	LED PROJİKTÖR 200W 3000K GOLD SERİSİ (SHUN.)	34
BL-P4-0024	LED PROJİKTÖR 200W 6500K GOLD SERİSİ (SHUN.)	34
BL-P4-0025	LED PROJİKTÖR 300W 3000K GOLD SERİSİ (SHUN.)	34
BL-P4-0027	LED PROJİKTÖR 300W 6500K GOLD SERİSİ (SHUN.)	34

Ürün Kodu	Ürün Açıklaması	Sayfa No
BL-P4-0028	LED PROJİKTÖR 400W 3000K GOLD SERİSİ (SHUN.)	34
BL-P4-0030	LED PROJİKTÖR 400W 6500K GOLD SERİSİ (SHUN.)	34
BL-P2-0001	LED PROJİKTÖR 10W 6500K PLATİN SERİSİ (NING.)	36
BL-P2-0002	LED PROJİKTÖR 10W 4000K PLATİN SERİSİ (NING.)	36
BL-P2-0003	LED PROJİKTÖR 10W 3000K PLATİN SERİSİ (NING.)	36
BL-P2-0004	LED PROJİKTÖR 20W 6500K PLATİN SERİSİ (NING.)	36
BL-P2-0005	LED PROJİKTÖR 20W 4000K PLATİN SERİSİ (NING.)	36
BL-P2-0006	LED PROJİKTÖR 20W 3000K PLATİN SERİSİ (NING.)	36
BL-P2-0007	LED PROJİKTÖR 30W 6500K PLATİN SERİSİ (NING.)	36
BL-P2-0008	LED PROJİKTÖR 30W 4000K PLATİN SERİSİ (NING.)	36
BL-P2-0009	LED PROJİKTÖR 30W 3000K PLATİN SERİSİ (NING.)	36
BL-P2-0010	LED PROJİKTÖR 50W 6500K PLATİN SERİSİ (NING.)	36
BL-P2-0011	LED PROJİKTÖR 50W 4000K PLATİN SERİSİ (NING.)	36
BL-P2-0012	LED PROJİKTÖR 50W 3000K PLATİN SERİSİ (NING.)	36
BL-P2-0013	LED PROJİKTÖR 70W 6500K PLATİN SERİSİ (NING.)	36
BL-P2-0014	LED PROJİKTÖR 70W 4000K PLATİN SERİSİ (NING.)	36
BL-P2-0015	LED PROJİKTÖR 70W 3000K PLATİN SERİSİ (NING.)	36
BL-P2-0016	LED PROJİKTÖR 100W 6500K PLATİN SERİSİ (NING.)	36
BL-P2-0017	LED PROJİKTÖR 100W 4000K PLATİN SERİSİ (NING.)	36
BL-P2-0018	LED PROJİKTÖR 100W 3000K PLATİN SERİSİ (NING.)	36
BL-P2-0019	LED PROJİKTÖR 150W 6500K PLATİN SERİSİ (NING.)	36
BL-P2-0020	LED PROJİKTÖR 150W 4000K PLATİN SERİSİ (NING.)	36
BL-P2-0021	LED PROJİKTÖR 150W 3000K PLATİN SERİSİ (NING.)	36
BL-P2-0022	LED PROJİKTÖR 200W 6500K PLATİN SERİSİ (NING.)	36
BL-P2-0023	LED PROJİKTÖR 200W 4000K PLATİN SERİSİ (NING.)	36
BL-P2-0024	LED PROJİKTÖR 200W 3000K PLATİN SERİSİ (NING.)	36
BL-HB-1001	LED HIGHBAY 100W 3000K (ON-BOARD)	38
BL-HB-1002	LED HIGHBAY 100W 6500K (ON-BOARD)	38
BL-HB-1003	LED HIGHBAY 150W 3000K (ON-BOARD)	38
BL-HB-1004	LED HIGHBAY 150W 6500K (ON-BOARD)	38
BL-HB-1005	LED HIGHBAY 200W 3000K (ON-BOARD)	38
BL-HB-1006	LED HIGHBAY 200W 6500K (ON-BOARD)	38
BL-SP-0010	LED SOLAR SOKAK AYDINLATMA ARMATÜRÜ 80W 3000K	40
BL-SP-0011	LED SOLAR SOKAK AYDINLATMA ARMATÜRÜ 80W 4000K	40
BL-SP-0012	LED SOLAR SOKAK AYDINLATMA ARMATÜRÜ 80W 6500K	40
BL-SP-0013	LED SOLAR SOKAK AYDINLATMA ARMATÜRÜ 100W 3000K	40
BL-SP-0014	LED SOLAR SOKAK AYDINLATMA ARMATÜRÜ 100W 4000K	40
BL-SP-0015	LED SOLAR SOKAK AYDINLATMA ARMATÜRÜ 100W 6500K	40
BL-SS-0001	LED SOLAR SOKAK ARMATÜRÜ 3000K 200W	40
BL-SS-0002	LED SOLAR SOKAK ARMATÜRÜ 4000K 200W	40
BL-SS-0003	LED SOLAR SOKAK ARMATÜRÜ 6500K 200W	40
BL-SS-0004	LED SOLAR SOKAK ARMATÜRÜ 3000K 300W	40
BL-SS-0005	LED SOLAR SOKAK ARMATÜRÜ 4000K 300W	40
BL-SS-0006	LED SOLAR SOKAK ARMATÜRÜ 6500K 300W	40
BL-DOB-0001	LED SOKAK ARMATÜRLERİ 100W 3000K DOB	42
BL-DOB-0002	LED SOKAK ARMATÜRLERİ 100W 4000K DOB	42
BL-DOB-0003	LED SOKAK ARMATÜRLERİ 100W 6500K DOB	42
BL-DOB-0004	LED SOKAK ARMATÜRLERİ 150W 3000K DOB	42
BL-DOB-0005	LED SOKAK ARMATÜRLERİ 150W 4000K DOB	42
BL-DOB-0006	LED SOKAK ARMATÜRLERİ 150W 6500K DOB	42
BL-DOB-0007	LED SOKAK ARMATÜRLERİ 200W 3000K DOB	42
BL-DOB-0008	LED SOKAK ARMATÜRLERİ 200W 4000K DOB	42
BL-DOB-0009	LED SOKAK ARMATÜRLERİ 200W 6500K DOB	42
BL-SB-0001	SOLAR LED BAHCHE ARMATÜR 3W 3000K KARE	44
BL-SB-0002	SOLAR LED BAHCHE ARMATÜR 3W 6500K KARE	44
BL-SB-0003	SOLAR LED BAHCHE ARMATÜR 5.5W 3000K KARE	44
BL-SB-0004	SOLAR LED BAHCHE ARMATÜR 5.5W 6500K KARE	44
BL-SB-0005	SOLAR LED BAHCHE ARMATÜR 3W 3000K YUVARLAK	44
BL-SB-0006	SOLAR LED BAHCHE ARMATÜR 3W 6500K YUVARLAK	44
BL-SB-0007	SOLAR LED BAHCHE ARMATÜR 5.5W 3000K YUVARLAK	44

Ürün Kodu	Ürün Açıklaması	Sayfa No
BL-ETRF-0002	100W 10A 12V SLİM LED TRAF0 (ECO)	60
BL-ETRF-0003	150W 12.5A 12V SLİM LED TRAF0 (ECO)	60
BL-ETRF-0004	200W 16.5A 12V SLİM LED TRAF0 (ECO)	60
BL-ETRF-0005	300W 25A 12V SLİM LED TRAF0 (ECO)	60
BL-ETRF-0006	400W 33A 12V SLİM LED TRAF0 (ECO)	60
BL-STRF-0001	SLİM LED TRAF0 60W	61
BL-STRF-0002	SLİM LED TRAF0 120W	61
BL-STRF-0003	SLİM LED TRAF0 150W	61
BL-STRF-0004	SLİM LED TRAF0 200W	61
BL-STRF-0005	SLİM LED TRAF0 250W	61
BL-STRF-0006	SLİM LED TRAF0 360W	61
132-1453	SLİM MODEL ACİL AYDINLATMA KİTİ (2H-3H)	62
132-1454	KOMPAKT MODEL ACİL AYDINLATMA KİTİ (3H)	62
BR-MS001	MINİ SENSOR	64
BR-SA360	SİVA ALTI 360° SENSOR	64
BR-RS001	RADAR SENSOR	64
BR-SU360	SİVA ÜSTÜ 360° SENSOR	64
BL-B1-0007	LED KARE ARMATÜR 12W (6500K)	66
BL-B1-0008	LED KARE ARMATÜR 12W (3000K)	66
BL-B1-0009	LED UFO ARMATÜR 11W (6500K)	66
BL-B1-0010	LED UFO ARMATÜR 11W (3000K)	66
BL-B1-0011	LED İNCİ ARMATÜR 11W (6500K)	66
BL-B1-0012	LED İNCİ ARMATÜR 11W (3000K)	66
BL-B1-0015	LED OKYANUS ARMATÜR 24W (6500K)	66
BL-B1-0016	LED OKYANUS ARMATÜR 24W (3000K)	66
BL-B1-0017	LED İSTANBUL APLİK 11W (6500K)	66
BL-B1-0018	LED İSTANBUL APLİK 11W (3000K)	66
BL-B1-0019	LED ASOS APLİK 24W (6500K)	66
BL-B1-0020	LED ASOS APLİK 24W (3000K)	66
BL-B1-0002	LED EKOTA APLİK 12W (3000K)	67
BL-B1-0001	LED EKOTA APLİK 12W (6500K)	67
BL-B1-0003	LED EKOLIGHT APLİK 12W (6500K)	67
BL-B1-0004	LED EKOLIGHT APLİK 12W (3000K)	67
BL-B1-0005	LED NEMİLYER ARMATÜR 12W (6500K)	67
BL-B1-0006	LED NEMİLYER ARMATÜR 12W (3000K)	67
BR-00203-000	ARMATÜR UFO BEYAZ (İKİLİ KUTU)	70
BR-00248-000	ARMATÜR UFOLINE BEYAZ (İKİLİ KUTU)	70
BR-00203-010	ARMATÜR UFOLUX BEYAZ (İKİLİ KUTU)	70
BR-00203-020	ARMATÜR GÜNEŞ BEYAZ (İKİLİ KUTU)	70
BR-00248-010	ARMATÜR VEGA BEYAZ İKİLİ KUTU	70
BR-00244-000	ARMATÜR İSİS BEYAZ (İKİLİ KUTU)	70
BR-00220-000	ARMATÜR KRAL DEKORATİF BEYAZ (TEKİLİ KUTU)	70
BR-00220-001	ARMATÜR KRAL KAFESLİ BEYAZ (TEKİLİ KUTU)	70
BR-00244-010	ARMATÜR ASOS BEYAZ İKİLİ KUTU	71
BR-00242-000	ARMATÜR KARE BEYAZ (İKİLİ KUTU)	71
BR-00242-010	ARMATÜR KARE SOFT BEYAZ (İKİLİ KUTU)	71
BR-00245-000	ARMATÜR YASMIN BEYAZ (İKİLİ KUTU)	71
BR-00245-010	ARMATÜR NEPTÜN BEYAZ (İKİLİ KUTU)	71
BR-00201-000	ARMATÜR VENUS BEYAZ (İKİLİ KUTU)	71
BR-00222-000	ARMATÜR NEMİLYER DEKORATİF BEYAZ (TEKİLİ KUTU)	71
BR-00222-001	ARMATÜR NEMİLYER KAFESLİ BEYAZ (TEKİLİ KUTU)	71
BR-00201-010	ARMATÜR UZAY BEYAZ (İKİLİ KUTU)	72
BR-00247-000	ARMATÜR İSTANBUL BEYAZ (İKİLİ KUTU)	72
BR-00247-010	ARMATÜR BOSPHORUS BEYAZ (İKİLİ KUTU)	72
BR-00230-010	ARMATÜR GOK SOFT SÜ BEYAZ (TEKİLİ KUTU)	72
BR-00230-000	ARMATÜR GOK SÜ BEYAZ (TEKİLİ KUTU)	72
BR-00249-000	APLİK TAC BEYAZ (İKİLİ KUTU)	72
BR-00220-010	ARMATÜR PETEK DEKORATİF BEYAZ (TEKİLİ KUTU)	72
BR-00220-011	ARMATÜR PETEK KAFESLİ BEYAZ (TEKİLİ KUTU)	72
BR-00231-010	ARMATÜR OKYANUS SOFT BEYAZ (İKİLİ KUTU)	73
BR-00231-000	ARMATÜR OKYANUS BEYAZ (İKİLİ KUTU)	73
BR-00231-020	ARMATÜR ATLANTİK BEYAZ (İKİLİ KUTU)	73
BR-00206-000	ARMATÜR YAKUT BEYAZ (İKİLİ KUTU)	73
BR-00206-010	ARMATÜR İNCİ BEYAZ (İKİLİ KUTU)	73
BR-00307-000	APLİK EKOTA BEYAZ (İKİLİ KUTU)	73
BR-00246-000	APLİK EKOLIGHT BEYAZ (İKİLİ KUTU)	73
BR-00246-010	APLİK EKOSOFT BEYAZ (İKİLİ KUTU)	73
BR-00309-000	APLİK SAH BEYAZ (TEKİLİ KUTU)	74

Ürün Kodu	Ürün Açıklaması	Sayfa No
BR-00235-000	ARMATÜR AYNAUSTU BEYAZ (TEKİLİ KUTU)	74
BR-00306-000	APLİK KRALLIÇE BEYAZ (İKİLİ KUTU)	74
BR-001411	ARMATÜR ASKI TAKİMİ (DUY PORSELEN E27)	76
BR-GU-0001	DUY GU10	76
132-1535	DUY PORSELEN E27	76
BR-1515	FİS PRİZ - TOPRAKLI DİSİ FİS KLASİK	76
BR-1516	FİS PRİZ - L TIPI TOPRAKLI ERKEK FİS	76
BR-1510	FİS PRİZ - MONOFAZE ERKEK FİS	76
BR-1511	FİS PRİZ - TOPRAKLI ERKEK FİS	76
BR-1517	Siyah Monofaze Erkek Fiş	76
BR-818	SİGORTA KUTUSU 2 Lİ MUHURLU SÜ	78
BR-819	SİGORTA KUTUSU 4 LÜ MÜHÜRLÜ SÜ	78
BR-820	SİGORTA KUTUSU 2 Lİ SÜ	78
BR-821	SİGORTA KUTUSU 2 Lİ SA	78
BR-804	SİGORTA KUTUSU 6 Lİ SÜ	78
BR-803	SİGORTA KUTUSU 6 Lİ SA	78
BR-806	SİGORTA KUTUSU 9 LU SÜ	79
BR-805	SİGORTA KUTUSU 9 LU SA	79
BR-808	SİGORTA KUTUSU 12 Lİ SÜ	79
BR-807	SİGORTA KUTUSU 12 Lİ SA	79
BR-816	SİGORTA KUTUSU 16 Lİ SÜ	79
BR-815	SİGORTA KUTUSU 16 Lİ SA	79
BR-814	SİGORTA KUTUSU 18 Lİ SÜ	80
BR-813	SİGORTA KUTUSU 18 Lİ SA	80
BR-810	SİGORTA KUTUSU 24 LU SÜ	80
BR-809	SİGORTA KUTUSU 24 LU SA	80
BR-812	SİGORTA KUTUSU 36 Lİ SÜ	80
BR-811	SİGORTA KUTUSU 36 Lİ SA	80
BR-750	TESİSAT - BUAT - TERMOPLASTİK 80x70	82
BR-760	TESİSAT - BUAT - TERMOPLASTİK 85x85	82
BR-770	TESİSAT - BUAT - TERMOPLASTİK 110x110	82
BR-730	TESİSAT - BUAT - LUKS KARE 80x80x40	82
BR-731	TESİSAT - BUAT - LUKS KARE 100x100x45	82
BR-732	TESİSAT - BUAT - LUKS KARE 130x130x55	82
BR-734	TESİSAT - BUAT - LUKS KARE 150x150x58	82
BR-733	TESİSAT - BUAT - LUKS KARE 200x200x70	82
BR-1713	TESİSAT - KASA - ALÇIPAN BUAT	82
BR-710	TESİSAT - BUAT - LUKS KAPAGI	82
BR-1413	TESİSAT - KASA - GECMELİ NORM (TURUNCU)	82
BR-1712	TESİSAT - KASA - ALÇIPAN	82
BR-1413-E	TESİSAT - KASA - GECMELİ NORM (SİYAH)	82
BR-1712-E	TESİSAT - KASA - ALÇIPAN (SİYAH)	82
BR-1780 M5	TESİSAT - KABLO PABUCU - BORSAN 6 MM² M5	84
BR-1780-M5K	TESİSAT - KABLO PABUCU - BORSAN 6 MM² M5 (Küçük Kutu)	84
BR-1781 M5	TESİSAT - KABLO PABUCU - BORSAN 10 MM² M5	84
BR-1781-M5K	TESİSAT - KABLO PABUCU - BORSAN 10 MM² M5 (Küçük Kutu)	84
BR-1782 M6	TESİSAT - KABLO PABUCU - BORSAN 16 MM² M6	84
BR-1782-M6K	TESİSAT - KABLO PABUCU - BORSAN 16 MM² M6 (Küçük Kutu)	84
BR-1782-M8	TESİSAT - KABLO PABUCU - BORSAN 16 MM² M8	84
BR-1782-M8K	TESİSAT - KABLO PABUCU - BORSAN 16 MM² M8 (EKO Küçük kutu)	84
BR-1783 M8	TESİSAT - KABLO PABUCU - BORSAN 25 MM² M8	84
BR-1783-M8K	TESİSAT - KABLO PABUCU - BORSAN 25 MM² M8 (Küçük Kutu)	84
BR-1784 M8	TESİSAT - KABLO PABUCU - BORSAN 35 MM² M8	84
BR-1784-M8K	TESİSAT - KABLO PABUCU - BORSAN 35 MM² M8 (Küçük Kutu)	84
BR-1794 M10	TESİSAT - KABLO PABUCU - BORSAN 35 MM² M10	84
BR-1794 M10K	TESİSAT - KABLO PABUCU - BORSAN 35 MM² (Küçük Kutu)	84
BR-1785 M10	TESİSAT - KABLO PABUCU - BORSAN 50 MM² M10	84
BR-1785-M10K	TESİSAT - KABLO PABUCU - BORSAN 50 MM² M10 (Küçük Kutu)	84
BR-1785 M12	TESİSAT - KABLO PABUCU - BORSAN 50 MM² M12	84
BR-1786 M10	TESİSAT - KABLO PABUCU - BORSAN 70 MM² M10	84
BR-1786 M12	TESİSAT - KABLO PABUCU - BORSAN 70 MM² M12	84
BR-1787 M8	TESİSAT - KABLO PABUCU - BORSAN 95 MM² M8	84
BR-1787 M10	TESİSAT - KABLO PABUCU - BORSAN 95 MM² M10	84
BR-1787 M12	TESİSAT - KABLO PABUCU - BORSAN 95 MM² M12	84
BR-1787 M14	TESİSAT - KABLO PABUCU - BORSAN 95 MM² M14	84
BR-1788 M10	TESİSAT - KABLO PABUCU - BORSAN 120 MM² M10	84
BR-1788 M12	TESİSAT - KABLO PABUCU - BORSAN 120 MM² M12	84
BR-1788 M14	TESİSAT - KABLO PABUCU - BORSAN 120 MM² M14	84

Ürün Kodu	Ürün Açıklaması	Sayfa No
BR-1789 M10	TESİSAT - KABLO PABUCU - BORSAN 150 MM² M10	84
BR-1789 M12	TESİSAT - KABLO PABUCU - BORSAN 150 MM² M12	84
BR-1789 M16	TESİSAT - KABLO PABUCU - BORSAN 150 MM² M16	84
BR-1790 M12	TESİSAT - KABLO PABUCU - BORSAN 185 MM² M12	84
BR-1790 M16	TESİSAT - KABLO PABUCU - BORSAN 185 MM² M16	84
BR-1791 M16	TESİSAT - KABLO PABUCU - BORSAN 240 MM² M16	84
BR-1792 M16	TESİSAT - KABLO PABUCU - BORSAN 300 MM² M16	84
BR-1792 M20	TESİSAT - KABLO PABUCU - BORSAN 300 MM² M20	84
BR-1793 M20	TESİSAT - KABLO PABUCU - BORSAN 400 MM² M20	84
BL-RS-0001	LED RAY SPOT 40W 3000K SİYAH	86
BL-RS-0002	LED RAY SPOT 40W 4000K SİYAH	86
BL-RS-0003	LED RAY SPOT 40W 6500K SİYAH	86
BL-RS-1004	LED RAY SPOT 30W (3000K) SİYAH	86
BL-RS-1005	LED RAY SPOT 30W (4000K) SİYAH	86
BL-RS-1006	LED RAY SPOT 30W (6500K) SİYAH	86
BL-RS-1001	LED RAY SPOT 40W (3000K) BEYAZ	86
BL-RS-1002	LED RAY SPOT 40W (4000K) BEYAZ	86
BL-RS-1003	LED RAY SPOT 40W (6500K) BEYAZ	86
BL-RS-1007	LED RAY SPOT 30W (3000K) BEYAZ	86
BL-RS-1008	LED RAY SPOT 30W (4000K) BEYAZ	86
BL-RS-1009	LED RAY SPOT 30W (6500K) BEYAZ	86
BL-PRJ-0001	LED SOKAK AYDINLATMA PROJE 50W 3000K	87
BL-PRJ-0002	LED SOKAK AYDINLATMA PROJE 50W 4000K	87
BL-PRJ-0003	LED SOKAK AYDINLATMA PROJE 50W 6500K	87
BL-PRJ-0004	LED SOKAK AYDINLATMA PROJE 100W 3000K	87
BL-PRJ-0005	LED SOKAK AYDINLATMA PROJE 100W 4000K	87
BL-PRJ-0006	LED SOKAK AYDINLATMA PROJE 100W 6500K	87
BL-PRJ-0007	LED SOKAK AYDINLATMA PROJE 150W 3000K	87
BL-PRJ-0008	LED SOKAK AYDINLATMA PROJE 150W 4000K	87
BL-PRJ-0009	LED SOKAK AYDINLATMA PROJE 150W 6500K	87
BL-PRJ-0010	LED SOKAK AYDINLATMA PROJE 200W 3000K	87
BL-PRJ-0011	LED SOKAK AYDINLATMA PROJE 200W 4000K	87
BL-PRJ-0012	LED SOKAK AYDINLATMA PROJE 200W 6500K	87
BL-PRJ-0013	LED SOKAK AYDINLATMA PROJE 300W 3000K	87
BL-PRJ-0014	LED SOKAK AYDINLATMA PROJE 300W 4000K	87
BL-PRJ-0015	LED SOKAK AYDINLATMA PROJE 300W 6500K	87
BL-Y1-0007	LED ALÜMİNYUM YÜKSEK TAVAN ARMATÜR 1200MM 110W 3000K	88
BL-Y1-0007-3H	LED ALÜMİNYUM YÜKSEK TAVAN ARMATÜR 1200MM 110W 3000K (3H ACİL KİTLİ)	88
BL-Y1-0008	LED ALÜMİNYUM YÜKSEK TAVAN ARMATÜR 1200MM 110W 4000K	88
BL-Y1-0008-3H	LED ALÜMİNYUM YÜKSEK TAVAN ARMATÜR 1200MM 110W 4000K (3H ACİL KİTLİ)	88
BL-Y1-0009	LED ALÜMİNYUM YÜKSEK TAVAN ARMATÜR 1200MM 110W 6500K	88
BL-Y1-0009-3H	LED ALÜMİNYUM YÜKSEK TAVAN ARMATÜR 1200MM 110W 6500K (3H ACİL KİTLİ)	88
BL-Y1-0010	LED ALÜMİNYUM YÜKSEK TAVAN ARMATÜR 1500MM 135W 3000K	88
BL-Y1-0010-3H	LED ALÜMİNYUM YÜKSEK TAVAN ARMATÜR 1500MM 135W 3000K (3H ACİL KİTLİ)	88
BL-Y1-0011	LED ALÜMİNYUM YÜKSEK TAVAN ARMATÜR 1500MM 135W 4000K	88
BL-Y1-0011-3H	LED ALÜMİNYUM YÜKSEK TAVAN ARMATÜR 1500MM 135W 4000K (3H ACİL KİTLİ)	88
BL-Y1-0012	LED ALÜMİNYUM YÜKSEK TAVAN ARMATÜR 1500MM 135W 6500K	88
BL-Y1-0012-3H	LED ALÜMİNYUM YÜKSEK TAVAN ARMATÜR 1500MM 135W 6500K (3H ACİL KİTLİ)	88
BL-EX-0001	LED EX-PROOF ETANJ ARMATÜR 20W 3000K (TURUNCU)	89
BL-EX-0002	LED EX-PROOF ETANJ ARMATÜR 20W 4000K (TURUNCU)	89
BL-EX-0003	LED EX-PROOF ETANJ ARMATÜR 20W 6500K (TURUNCU)	89
BL-EX-0004	LED EX-PROOF ETANJ ARMATÜR 40W 3000K (TURUNCU)	89
BL-EX-0005	LED EX-PROOF ETANJ ARMATÜR 40W 4000K (TURUNCU)	89
BL-EX-0006	LED EX-PROOF ETANJ ARMATÜR 40W 6500K (TURUNCU)	89
BL-EX-0007	LED EX-PROOF ETANJ ARMATÜR 60W 3000K (TURUNCU)	89
BL-EX-0008	LED EX-PROOF ETANJ ARMATÜR 60W 4000K (TURUNCU)	89
BL-EX-0009	LED EX-PROOF ETANJ ARMATÜR 60W 6500K (TURUNCU)	89
BL-AC-0004	ACİL AYDINLATMA ARMATÜRÜ (YUKARI) 3H ACİL KİT	90
BL-AC-0002	ACİL AYDINLATMA ARMATÜRÜ (ASAĞI) 3H ACİL KİT	90
BL-AC-0003	ACİL AYDINLATMA ARMATÜRÜ (İLERİ) 3H ACİL KİT	90
BLT-O2-2002	LED 60x60 OPAL LENSİLİ BACKLIGHT 36W 4000K SİVA ALTI TSE	91
BLT-O2-2003	LED 60x60 OPAL LENSİLİ BACKLIGHT 36W 6500K SİVA ALTI TSE	91
BLT-O2-2008	LED 60x60 OPAL LENSİLİ BACKLIGHT 36W 4000K CLIP-IN TSE	92
BLT-O2-2009	LED 60x60 OPAL LENSİLİ BACKLIGHT 36W 6500K CLIP-IN TSE	92
BLT-O5-2008	LED 60x60 OPAL LENSİLİ BACKLIGHT 36W 4000K SİVA USTU TSE	92
BLT-O5-2009	LED 60x60 OPAL LENSİLİ BACKLIGHT 36W 6500K SİVA USTU TSE	92
BHKT-01	HAVA KAÇAK TESPİT CİHAZI	94

2017 yılı itibari ile LED'li aydınlatma ürün imalatında faaliyete geçen Borled Aydınlatma, modern LED ve 40 yılı aşkın Borsan tecrübesi sayesinde güçlü bir büyüme sergilemiştir. Borled, 2025 itibari ile faaliyetlerini Borled by Borsan kurumsal markası ve Borled Aydınlatma tüzel kişiliği ile, yine Borsan Grup bünyesinde sürdürmektedir.

Gerek Türkiye pazarında gerekse başta Ortadoğu, Afrika, Türki Cumhuriyetler ve Avrupa olmak üzere ihracat pazarlarında yüksek kalite algısına ve marka gücüne sahip olan Borled by Borsan, belirlemiş olduğu hedeflere bu yeni yapısıyla ve Borsan markasının birçok ülkede sahip olduğu saygın konumun desteğiyle yürüyüşünü sürdürmektedir.

Borled by Borsan yine 2025 yılı başında, özellikle Orta Doğu, Afrika ve Asya pazarlarına aktif ihracat gerçekleştiren, Ar-Ge, Özel Tasarım ve Ürün Montaj kabiliyetleri ile bilinen; elektrik, elektronik ve LED konusunda çok yüksek know-how birikimine sahip, Çin merkezli Lixin Lighting firmasıyla ortaklık sözleşmesine imza atmıştır.

Borled by Borsan bu ortaklıkla kaliteden taviz vermeden, verimliliği artırarak rekabetçi fiyat yapısını ulaştırırken, aynı zamanda ürün çeşitliliğini de artırmayı hedeflemektedir. Aynı zamanda Lixin Lighting ile ortaklaşa olarak, 2025-2028 arası 3 yıllık dönemde teknoloji transferi, Ar-Ge ve kapasite artırımı odaklı olarak 25 milyon dolar düzeyinde yatırım planlanmış durumdadır. Borled by Borsan cirosunun, bu yatırımlarla 3 yıl içerisinde 3 katın üzerinde bir büyüme performansı ile 35 milyon dolar ciroya ulaşması hedeflenmektedir.

İlk aşamada makine ve işletme sermayesi odaklı olarak, 2025 yılı içerisinde yüksek fikri mülkiyet değeri özelliğine sahip etanj armatür ve hali hazırda Türkiye'de üretimi yapılamayan NEON üretim için makine ve kalıp yatırımları gerçekleştirecek ve yatırımlar, NEON aydınlatma üretimi, dizgi ve metal baskı, boya makine gibi alanlarda devam edecektir. Yatırımlar paralelinde ciroda 3 katın üzerinde büyümenin yanı sıra, özellikle kadın çalışan ağırlıklı 100 kişilik yeni istihdam oluşturulması da hedeflenmektedir. Borsan Grubun genel prensibi olan kadın istihdamında pozitif ayrımcılık kapsamında kadın çalışanlara öncelik vermeye devam edilecektir.

Çin, LED ve Elektronik üretiminde dünyanın inovasyon merkezi durumundadır ve LED Aydınlatma teknolojilerinin dünya genelindeki gelişimine ve sektörün küresel üretimine Çin merkezli firmalar yön vermektedir. Ancak, Çin'de geliştirilen yeni tasarımlı ve teknoloji LED aydınlatma ürünlerinin, özellikle Türkiye ve çevresinde pazara sunulması belirli bir faz farkı ile gerçekleşmektedir. Lixin Lighting iş birliği, en son nesil tasarım ve ürünlerin, Türkiye ve ihracat pazarlarına daha hızlı ve 'Made in Türkiye' markasının gücüyle ile sunulmasıyla rekabet avantajı sağlayacaktır. Borled Aydınlatma'nın özellikle ihracat pazarlarındaki büyümesi, böylece 'Made in Türkiye' algısına da katkı yapacak niteliktedir.

Samsun Organize Sanayi Bölgesi içerisinde bulunan, 15.000m²'lik kapalı alanda üretim ve ürün tasarımları yapan Borled Aydınlatma Fabrikası, plastik üretim hatlarında 880 bin, saç metal üretim hatlarında 750 bin, montaj ve paketleme hatlarında ise 334 bin adet aylık kapasiteye sahiptir. Borled by Borsan üretim kimliği, yüksek teknolojiye sahip üretim ekipmanları, laboratuvarı ve kalite yönetimini destekleyen test alanları, müşteri odaklı yurtiçi/ yurtdışı satış ve pazarlama departmanları, paydaşlarının ihtiyaç duyacağı tüm gereksinimleri karşılamaktadır.

Borled by Borsan ürün gruplarında, dünyada süregelen teknolojik gelişmeler ışığında dayanıklılık, verimlilik ve tasarruf değerleri en üst düzeye çıkmaktadır. Toplam kalite yönetimi anlayışı, müşteri memnuniyetini her zaman ön planda tutmaktadır.

Borled by Borsan TSE, CE, RoHS gibi ulusal kalite belgeleri ve uluslararası deklarasyonlarına sahip ürünleri ile konut, okul, hastane, ofis, AVM, endüstriyel tesisler ve kamu kuruluşları gibi alanlarda hizmet vermektedir. Bünyesinde bulunan test laboratuvarları, makine parkuru ve uzman kadrosu ile daha fazla alana hizmet vermek için çalışmalarını sürdürmektedir. Borsan faaliyet gösterdiği tüm sektörlerde bir dünya markası vizyonuna ulaşabilmek için Ar-Ge faaliyetlerine sürekli yatırım yapmaktadır.

Sanayi ve Teknoloji Bakanlığı tarafından 2018 yılında tescil edilen Borsan Ar-Ge Merkezi 350m² alanda kurulu Karadeniz'in en büyük Aydınlatma Laboratuvarının yanı sıra, Yangın test Laboratuvarı, Metal ve Polimer Laboratuvarı gibi bölümlerde özel ekipman, cihazlar ve test programlarının kullanılmakta, yirminin üzerinde Ar-Ge mühendisi ve araştırmacı personel görev yapmaktadır.

Borled Aydınlatma Laboratuvarı, her koşulda üstün niteliklere sahip aydınlatma ekipmanlarının tasarımına olanak sağlamaktadır. Uzman ekibi ve modern teknolojisi sayesinde, ışığın hem matematiksel hem de insan fizyolojisini olumlu etkileyecek özelliklerini belirleyerek, tasarımları ve kalitesini her zaman en üst seviyede sunmaktadır. Borled Aydınlatma Laboratuvarı, iç ve dış mekân aydınlatması ile ilgili TS EN 60598-1 (Aydınlatma Armatürleri Güvenlik Gereksinimleri) standardına uygun olarak ölçümler gerçekleştirmektedir. Ürünlerin güvenlik testleri, armatür ve lambaların fotometrik değerleri, elektriksel, kimyasal ve fiziksel özelliklerinin ölçümleri yapılmakta olup, cihazlarda yapılan periyodik ara kontrol ve kalibrasyonlar sayesinde ürün kalitesi en üst seviyede tutulmaktadır.

Borsan bünyesinde Borled by Borsan, yenilikçilik ruhu ile sürekli yeni ürünler geliştiren, kalitesiyle fark yaratan geleceğe gururla taşınan Türkiye'nin lider markalardan biri olmaya daima devam edecektir.





Borled Lighting has been actively engaged in the production of LED lighting products since As of 2017, and demonstrated strong growth with its modern LED technology and Borsan's over 40 years of experience. As of 2025, Borled continues its operations under the corporate brand Borled by Borsan and the legal entity Borled Lighting, remaining within the structure of the Borsan Group.

Borled by Borsan enjoys a strong brand perception and reputation for high quality, both in the Turkish market and in export markets, particularly in the Middle East, Africa, Turkic Republics, and Europe. With this new structure and the strong global position of the Borsan brand, the company continues its journey toward achieving its long term objectives. At the beginning of 2025, Borled by Borsan signed a partnership agreement with Lixin Lighting, a China-based company known for its extensive know-how in electricity, electronics, and LED technologies. Lixin Lighting is actively involved in exports to the Middle East, Africa, and Asia and is recognized for its R&D, custom design, and product assembly capabilities.

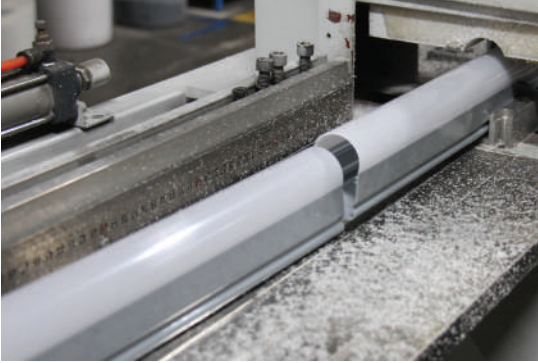

Through this partnership, Borled by Borsan aims to enhance efficiency, and expand its product range, while maintaining high quality and achieving a competitive pricing structure. A \$25 million investment is planned for the 2025-2028 period, focusing on technology transfer, R&D, and capacity expansion. With these investments, Borled by Borsan aims to triple its revenue within three years, reaching an annual turnover of \$35 million.

In the initial phase, investments will be made in machines and molds for the production of watertight luminaires and NEON lighting, which are currently not manufactured in Turkey. Further investments will be directed toward NEON lighting production, assembly, metal pressing, and painting machines. Alongside revenue growth, the company plans to create 100 new jobs, with a particular focus on employing women in line with Borsan Group's policy of gender-inclusive hiring.



China serves as the global innovation hub for LED and electronics manufacturing, playing a pivotal role in the development of LED lighting technologies worldwide. However, newly developed LED lighting products in China often enter markets such as Turkey with a certain time lag. The partnership with Lixin Lighting will enable Borled by Borsan to introduce the latest-generation designs and products to Turkey and export markets more swiftly, leveraging the strength of the Made in Türkiye brand for a competitive advantage. This strategy will not only drive Borled Lighting's export growth but also contribute to the Made in Türkiye brand perception on an international scale.

Located in the Samsun Organized Industrial Zone, Borled Lighting operates a 15,000m² enclosed production and design facility. The factory boasts an impressive monthly production capacity of 880,000 units in plastic production lines, 750,000 units in sheet metal production lines, and 334,000 units in assembly and packaging lines.

Borled by Borsan's manufacturing identity is reinforced by state-of-the-art production equipment, laboratories, and testing areas that support its quality management system. With a strong focus on customer satisfaction, the company's domestic and international sales and marketing teams ensure that all stakeholder requirements are met.

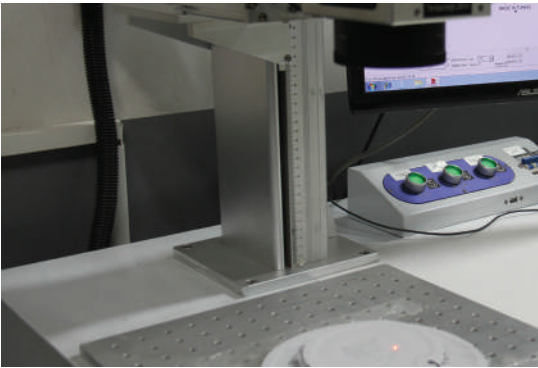

Borled by Borsan's product lines are designed with the latest technological advancements to maximize durability, efficiency, and energy savings. The company adheres to Total Quality Management principles, always prioritizing customer satisfaction.

Certified with TSE, CE, RoHS, and other national and international quality standards, Borled by Borsan serves a variety of industries, including residential, educational, healthcare, office, shopping mall, industrial, and public sector applications. The company continues to expand its services through its in-house testing laboratories, advanced machinery, and expert team.

Borsan Group continually invests in R&D to establish itself as a global brand across all industries in which it operates. Registered by the Ministry of Industry and Technology in 2018, the Borsan R&D Center is home to the largest lighting laboratory in the Black Sea region (350m²). It also features a Fire Testing Laboratory, Metal and Polymer Laboratory, and other specialized research facilities. The center employs over 20 R&D engineers and researchers utilizing advanced equipment and testing programs.

The Borled Lighting Laboratory is dedicated to designing high-performance lighting equipment under all conditions. With its expert team and cutting-edge technology, it ensures that lighting designs optimize both mathematical precision and human physiological well-being. The laboratory conducts measurements in compliance with the TS EN 60598-1 (Lighting Fixtures Safety Requirements) standard. It performs safety tests, photometric evaluations, and electrical, chemical, and physical property analyses on products. Periodic inspections and calibrations of devices ensure that product quality remains at the highest level.

With its spirit of innovation, Borled by Borsan continues to develop new products that stand out for their quality and technological advancements. As one of Turkey's leading brands, it remains committed to shaping the future with pride.



SLIM LED PANELLER

Zarif Tasarım, Verimli Aydınlatma





Enerji Verimliliği Sınıfı	Ürün Kodu	Güç (W)	Renk Sıcaklığı (K)	Işık Akısı (Lm)	Boyutlar (ØxH) mm	Kesme Ebatı (Ø) mm	Koli Adeti	Fiyat
A+G	BL-S1-2001	3W	3000 K	165	82 x 14	73	48	3,90 \$
A+G	BL-S1-2002		4000 K		82 x 14	73	48	3,90 \$
A+G	BL-S1-2003		6500 K		82 x 14	73	48	3,90 \$
A+G	BL-S1-2004	6W	3000 K	390	118 x 14	110	48	5,10 \$
A+G	BL-S1-2005		4000 K		118 x 14	110	48	5,10 \$
A+G	BL-S1-2006		6500 K		118 x 14	110	48	5,10 \$
A+G	BL-S1-2007	9W	3000 K	630	145 x 14	135	24	6,40 \$
A+G	BL-S1-2008		4000 K		145 x 14	135	24	6,40 \$
A+G	BL-S1-2009		6500 K		145 x 14	135	24	6,40 \$
A+G	BL-S1-2010	12W	3000 K	960	168 x 14	155	24	7,10 \$
A+G	BL-S1-2011		4000 K		168 x 14	155	24	7,10 \$
A+G	BL-S1-2012		6500 K		168 x 14	155	24	7,10 \$
A+G	BL-S1-2013	15W	3000 K	1200	190 x 14	175	24	8,50 \$
A+G	BL-S1-2014		4000 K		190 x 14	175	24	8,50 \$
A+G	BL-S1-2015		6500 K		190 x 14	175	24	8,50 \$
A+G	BL-S1-2016	18W	3000 K	1440	225 x 15	210	24	9,00 \$
A+G	BL-S1-2017		4000 K		225 x 15	210	24	9,00 \$
A+G	BL-S1-2018		6500 K		225 x 15	210	24	9,00 \$
A+G	BL-S1-2019	24W	3000 K	2040	300 x 15	285	24	14,00 \$
A+G	BL-S1-2020		4000 K		300 x 15	285	24	14,00 \$
A+G	BL-S1-2021		6500 K		300 x 15	285	24	14,00 \$



Çerçeve Çapı



Enerji Verimliliği Sınıfı	Ürün Kodu	Güç (W)	Renk Sıcaklığı (K)	Işık Akısı (Lm)	Boyutlar (ØxH) mm	Kesme Ebatı (Ø) mm	Koli Adeti	Fiyat
A+G	BL-S1-2001-S	3W	3000 K	165	82 x 14	73	48	4,10 \$
A+G	BL-S1-2002-S		4000 K		82 x 14	73	48	4,10 \$
A+G	BL-S1-2003-S		6500 K		82 x 14	73	48	4,10 \$
A+G	BL-S1-2004-S	6W	3000 K	390	118 x 14	110	48	5,40 \$
A+G	BL-S1-2005-S		4000 K		118 x 14	110	48	5,40 \$
A+G	BL-S1-2006-S		6500 K		118 x 14	110	48	5,40 \$
A+G	BL-S1-2007-S	9W	3000 K	630	145 x 14	135	24	6,70 \$
A+G	BL-S1-2008-S		4000 K		145 x 14	135	24	6,70 \$
A+G	BL-S1-2009-S		6500 K		145 x 14	135	24	6,70 \$
A+G	BL-S1-2010-S	12W	3000 K	960	168 x 14	155	24	7,50 \$
A+G	BL-S1-2011-S		4000 K		168 x 14	155	24	7,50 \$
A+G	BL-S1-2012-S		6500 K		168 x 14	155	24	7,50 \$
A+G	BL-S1-2013-S	15W	3000 K	1200	190 x 14	175	24	9,00 \$
A+G	BL-S1-2014-S		4000 K		190 x 14	175	24	9,00 \$
A+G	BL-S1-2015-S		6500 K		190 x 14	175	24	9,00 \$
A+G	BL-S1-2016-S	18W	3000 K	1440	225 x 15	210	24	9,50 \$
A+G	BL-S1-2017-S		4000 K		225 x 15	210	24	9,50 \$
A+G	BL-S1-2018-S		6500 K		225 x 15	210	24	9,50 \$
A+G	BL-S1-2019-S	24W	3000 K	2040	300 x 15	285	24	14,70 \$
A+G	BL-S1-2020-S		4000 K		300 x 15	285	24	14,70 \$
A+G	BL-S1-2021-S		6500 K		300 x 15	285	24	14,70 \$



Çerçeve Çapı



Sıvaaltı Kare Slim LED Armatür
Flush Mounted Square Slim LED Armature

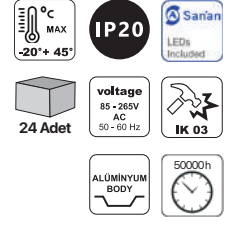
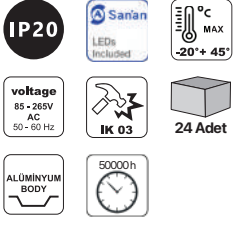

Enerji Verimliliği Sınıfı	Ürün Kodu	Güç (W)	Renk Sıcaklığı (K)	Işık Akısı (Lm)	Ürün Ölçüsü WxLxH mm	Kesme Ebatı (Ø) mm	Fiyat
A	BL-S1-2022	18W	3000 K	1350	220 x 220 x 15	205 x 205	11,70 \$
A	BL-S1-2023		4000 K		220 x 220 x 15		
A	BL-S1-2024		6500 K		220 x 220 x 15		
A	BL-S1-2025	24W	3000 K	1920	290 x 290 x 15	280 x 280	14,50 \$
A	BL-S1-2026		4000 K		290 x 290 x 15		
A	BL-S1-2027		6500 K		290 x 290 x 15		

Enerji Verimliliği Sınıfı	Ürün Kodu	Güç (W)	Renk Sıcaklığı (K)	Işık Akısı (Lm)	Ürün Ölçüsü WxLxH mm	Kesme Ebatı (Ø) mm	Fiyat
A	BL-S1-2022-S	18W	3000 K	1350	225 x 225 x 15	210 x 210	12,50 \$
A	BL-S1-2023-S		4000 K		225 x 225 x 15		
A	BL-S1-2024-S		6500 K		225 x 225 x 15		
A	BL-S1-2025-S	24W	3000 K	1920	285 x 285 x 15	280 x 280	15,30 \$
A	BL-S1-2026-S		4000 K		285 x 285 x 15		
A	BL-S1-2027-S		6500 K		285 x 285 x 15		

Sıvaüstü Yuvarlak LED Panel
Surface Mounted Round LED Panel

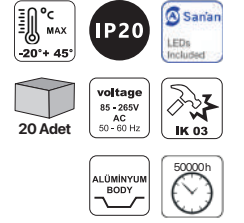
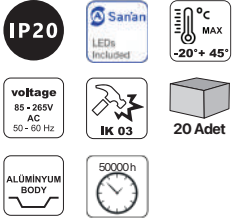

Enerji Verimliliği Sınıfı	Ürün Kodu	Güç (W)	Renk Sıcaklığı (K)	Işık Akısı (Lm)	Ürün Ölçüsü WxLxH mm	Fiyat
A	BL-S2-2013	15W	3000 K	1200	162 x 25	7,90 \$
A	BL-S2-2014		4000 K		162 x 25	
A	BL-S2-2015		6500 K		162 x 25	
A	BL-S2-2016	18W	3000 K	1440	210 x 25	10,40 \$
A	BL-S2-2017		4000 K		210 x 25	
A	BL-S2-2018		6500 K		210 x 25	
A	BL-S2-2019	24W	3000 K	2040	285 x 25	14,60 \$
A	BL-S2-2020		4000 K		285 x 25	
A	BL-S2-2021		6500 K		285 x 25	

Enerji Verimliliği Sınıfı	Ürün Kodu	Güç (W)	Renk Sıcaklığı (K)	Işık Akısı (Lm)	Ürün Ölçüsü WxLxH mm	Fiyat
A	BL-S2-2013-S	15W	3000 K	1200	162 x 25	9,20 \$
A	BL-S2-2014-S		4000 K		162 x 25	
A	BL-S2-2015-S		6500 K		162 x 25	
A	BL-S2-2016-S	18W	3000 K	1440	210 x 25	12,50 \$
A	BL-S2-2017-S		4000 K		210 x 25	
A	BL-S2-2018-S		6500 K		210 x 25	
A	BL-S2-2019-S	24W	3000 K	2040	285 x 25	16,70 \$
A	BL-S2-2020-S		4000 K		285 x 25	
A	BL-S2-2021-S		6500 K		285 x 25	

Sıva Üstü Kare LED Panel
Surface Mounted Square LED Panel

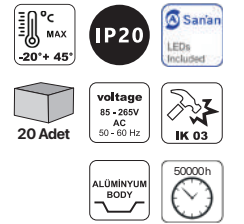
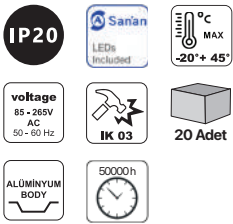

Enerji Verimliliği Sınıfı	Ürün Kodu	Güç (W)	Renk Sıcaklığı (K)	Işık Akısı (Lm)	Ürün Ölçüsü WxLxH mm	Fiyat
A	BL-S2-2022	15W	3000 K	1200	162 x 25	8,40 \$
A	BL-S2-2023		4000 K		162 x 25	
A	BL-S2-2024		6500 K		162 x 25	
A	BL-S2-2025	18W	3000 K	1440	210 x 25	11,20 \$
A	BL-S2-2026		4000 K		210 x 25	
A	BL-S2-2027		6500 K		210 x 25	
A	BL-S2-2028	24W	3000 K	2040	285 x 25	15,80 \$
A	BL-S2-2029		4000 K		285 x 25	
A	BL-S2-2030		6500 K		285 x 25	

Enerji Verimliliği Sınıfı	Ürün Kodu	Güç (W)	Renk Sıcaklığı (K)	Işık Akısı (Lm)	Ürün Ölçüsü WxLxH mm	Fiyat
A	BL-S2-2022-S	15W	3000 K	1200	162 x 25	9,60 \$
A	BL-S2-2023-S		4000 K		162 x 25	
A	BL-S2-2024-S		6500 K		162 x 25	
A	BL-S2-2025-S	18W	3000 K	1440	210 x 25	12,80 \$
A	BL-S2-2026-S		4000 K		210 x 25	
A	BL-S2-2027-S		6500 K		210 x 25	
A	BL-S2-2028-S	24W	3000 K	2040	285 x 25	18,10 \$
A	BL-S2-2029-S		4000 K		285 x 25	
A	BL-S2-2030-S		6500 K		285 x 25	



30x30 Slim LED Panel Armatür
30x30 Slim LED Panel Armature

IP20

Voltage
85 - 285V
AC
50 - 60 Hz

ALÜMİNYUM

50.000 h

LED

MAX
-20°+ 45°

IK 03



12 Adet



Enerji Verimliliği Sınıfı	Ürün Kodu	Güç (W)	Renk Sıcaklığı (K)	Işık Akısı (Lm)	Ürün Ölçüsü WxLxH mm	Fiyat
A G	BL-08-0001	24W	3000 K	1350	295 x 295 x 7,5	31,80 \$
A G	BL-08-0002		4000 K		295 x 295 x 7,5	31,80 \$
A G	BL-08-0003		6500 K		295 x 295 x 7,5	31,80 \$

60x60 Slim LED Panel Armatür
60x60 Slim LED Panel Armature

IP20

Voltage
85 - 285V
AC
50 - 60 Hz

Sanan
LEDs
Included

50.000 h

LED

MAX
-20°+ 45°

IK 02



12 Adet



Enerji Verimliliği Sınıfı	Ürün Kodu	Güç (W)	Renk Sıcaklığı (K)	Işık Akısı (Lm)	Ürün Ölçüsü WxLxH mm	Fiyat
A G	BL-05-2001	40W	3000 K	3600	595 x 595 x 7,5	46,30 \$
A G	BL-05-2002		4000 K		595 x 595 x 7,5	46,30 \$
A G	BL-05-2003		6500 K		595 x 595 x 7,5	46,30 \$
A G	BL-05-2003		6500 K		595 x 595 x 7,5	46,30 \$

LED Frameless Armatür

Ayarlanabilir Panel

Modern, Şık ve Ayarlanabilir Aydınlatma Çözümleri



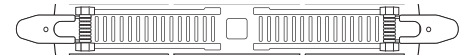
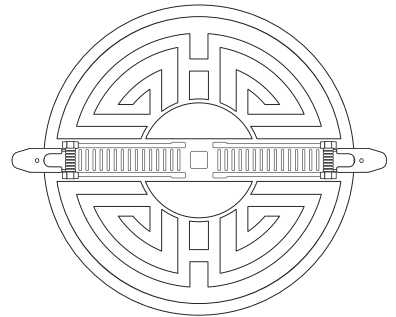
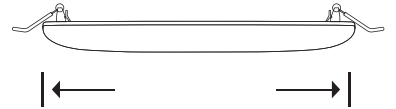
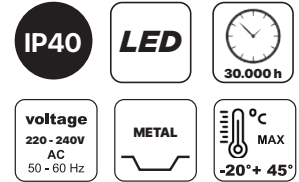

Ayarlanabilir Yayılar

Enerji Verimliliği Sınıfı	Ürün Kodu	Güç (W)	Renk Sıcaklığı (K)	Işık Akısı (Lm)	Ürün Ölçüsü WxLxH mm	Koli Adeti	Fiyat
A	BL-FA-0001	9W	3000 K	810	Ø90 x 19	90	4,70 \$
A	BL-FA-0002		4000 K				
A	BL-FA-0003		6500 K				
A	BL-FA-0004	18W	3000 K	1620	Ø120 x 19	60	5,50 \$
A	BL-FA-0005		4000 K				
A	BL-FA-0006		6500 K				
A	BL-FA-0007	24W	3000 K	2160	Ø170 x 19	60	7,50 \$
A	BL-FA-0008		4000 K				
A	BL-FA-0009		6500 K				
A	BL-FA-0010	36W	3000 K	3240	Ø220 x 19	36	10,50 \$
A	BL-FA-0011		4000 K				
A	BL-FA-0012		6500 K				

60X60 CCT Slim Backlight

Modern Tasarım, Yüksek Verimlilik.



60x60 CCT LED OPAL LENSİ SLIM BACKLIGHT ARMATÜR

Renk Değişirneli: 3000K, 4000K, 6500K



3000K
(Sıcak Beyaz)

4000K
(Nötr Beyaz)

6500K
(Soğuk Beyaz)



LED OPAL LENSİ BACKLIGHT CLIP-IN ARMATÜR LED BACKLIGHT CLIP-IN ARMATURE - OPAL LENS

LED 60x60 OPAL LENSİ BACKLIGHT SIVA ÜSTÜ ARMATÜR LED BACKLIGHT SURFACE MOUNTED ARMATURE - OPAL LENS

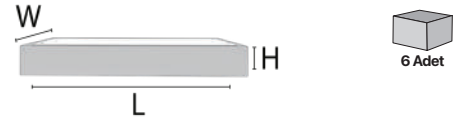
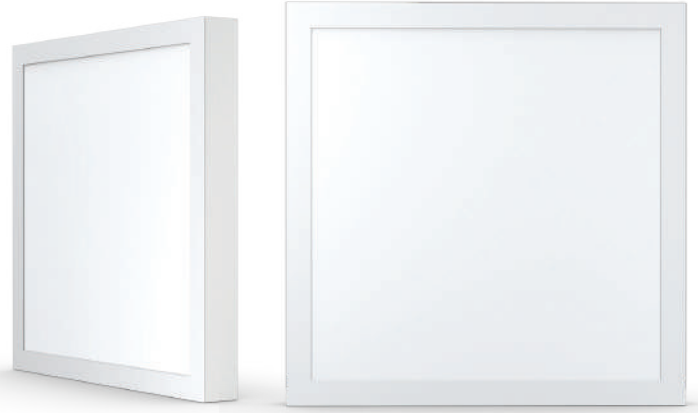
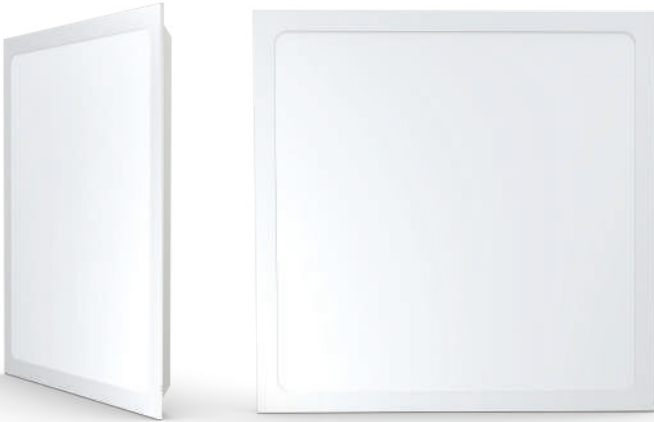

Enerji Verimliliği Sınıfı	Ürün Kodu	Güç (W)	Renk Sıcaklığı (K)	Işık Akısı (Lm)	Ürün Ölçüsü WxLxH mm	Fiyat
A+ F	BL-O2-2014	40W	3000 K	3600	595 x 595 x 35	32,70 \$
			4000 K			
			6500 K			
A+ F	BLT-O2-2014	40W	3000 K	3600	595 x 595 x 35	42,00 \$
			4000 K			
			6500 K			

Enerji Verimliliği Sınıfı	Ürün Kodu	Güç (W)	Renk Sıcaklığı (K)	Işık Akısı (Lm)	Ürün Ölçüsü WxLxH mm	Fiyat
A+ F	BL-O2-2014-SU	40W	3000 K	3600	600x600x65	66,80 \$
			4000 K			
			6500 K			

LED Opal Lens Backlight Clip-In Armatur

Homojen Aydınlatma, Şık ve Estetik Görünüm





30X30 Opal Lensli Clip-In Backligh



IP20

Voltage
85 - 265V
AC
50 - 60 Hz

Sağın
LEDs
Included

50.000 h

LED

°C
MAX
-20*+ 45*

IK 02



Enerji Verimliliği Sınıfı	Ürün Kodu	Güç (W)	Renk Sıcaklığı (K)	Işık Akısı (Lm)	Koli Adetleri	Ürün Ölçüsü ØxH mm	Fiyat
A E	BLT-02-3011	20W	4000 K	2000	8 Adet	300x300x65	Fiyat Sorunuz
A E	BLT-02-3012	20W	6500 K	2000	8 Adet	300x300x65	Fiyat Sorunuz



30X30 SLIM CLIP-IN BACKLIGHT PANEL

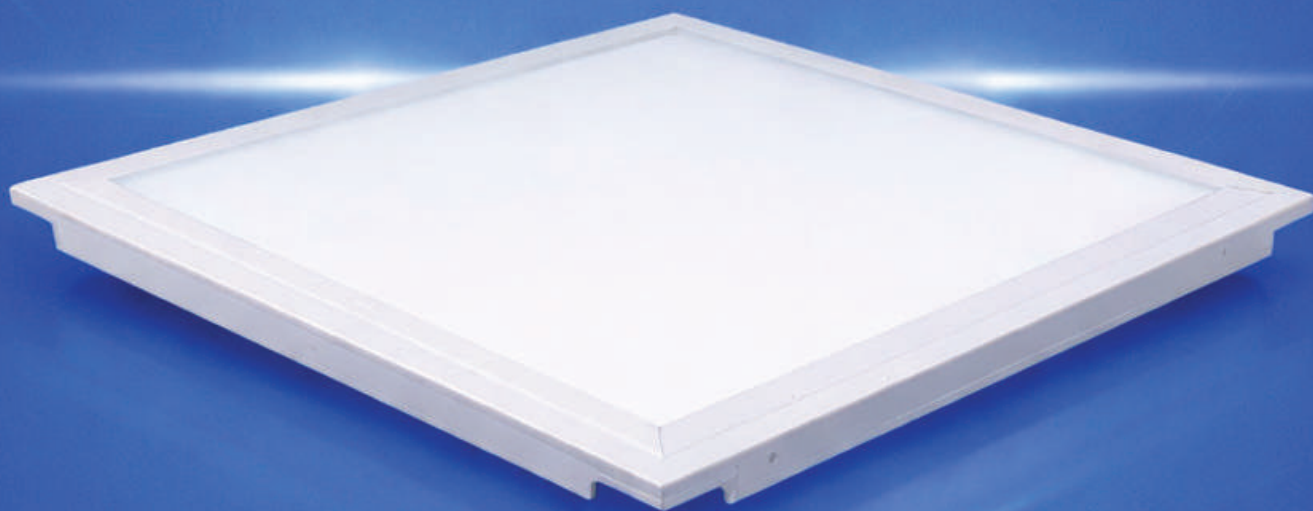

30X30 Sıva Altı Slim Backlight Clip-In

Modern Ofis ve Ticari Çözümler



30X30 Sıva Altı Slim Backlight Clip-In 30X30 Flush Mounting Backlight Clip-In

IP20



50.000 h

LED

ALÜMİNYUM



Voltage
85 - 265V
AC
50 - 60 Hz



IK 02



10 Adet



YENİ
ÜRÜN

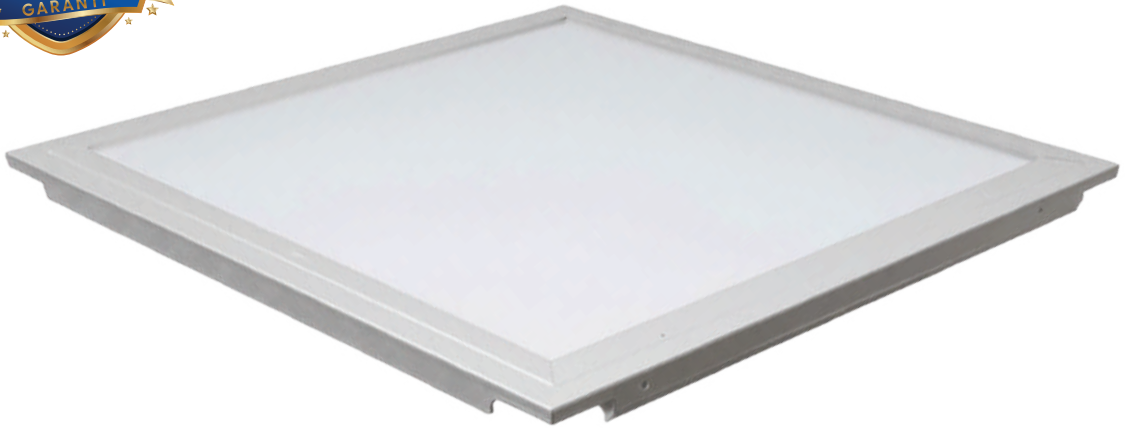

Enerji Verimliliği Sınıfı	Ürün Kodu	Güç (W)	Renk Sıcaklığı (K)	Işık Akısı (Lm)	Ürün Ölçüsü WxLxH mm	Fiyat
A	BL-02-2021	20W	3000 K	1800	295x295x35	21,90 \$
F	BL-02-2022		4000 K		295x295x35	21,90 \$
A	BL-02-2023		6500 K		295x295x35	21,90 \$

LED Mobil Spot

Yüksek Verimli, Ayarlanabilir Aydınlatma.





Ø 90 mm

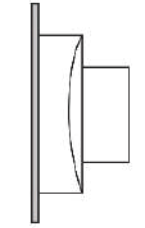
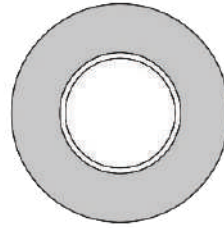

H 38 mm

IP20



voltage
220 - 240V
AC
50 - 60 Hz



MAX
°C
-20° + 45°



36 Adet

Enerji Verimliliği Sınıfı	Ürün Kodu	Güç (W)	Renk Sıcaklığı (K)	Işık Akısı (Lm)	Kesme Ebatı (Ø) mm	Renk	Fiyat
A	BL-MB-0001	5W	3000 K	400	75	Beyaz	6,80 \$
A	BL-MB-0002		4000 K		75	Beyaz	6,80 \$
A	BL-MB-0003		6500 K		75	Beyaz	6,80 \$
A	BL-MB-1001		3000 K		75	Siyah	6,80 \$
A	BL-MB-1002		4000 K		75	Siyah	6,80 \$
A	BL-MB-1003		6500 K		75	Siyah	6,80 \$

Neon LED Aydınlatma

Esnek ve Şık Aydınlatma Çözümleri





220 V NEON LED AYDINLATMA
220 V NEON LED LIGHTING

12 V NEON LED AYDINLATMA
12 V NEON LED LIGHTING

IP65

LED

voltage
220 + 240V
AC
50 - 60 Hz

50.000 h

°C
MAX
-20' + 45'



IP65

LED

DC
12V

50.000 h

°C
MAX
-20' + 45'



Enerji Verimliliği i Sınıfı	Ürün Kodu	Renk Sıcaklığı (K)	Işık Akısı (Lm)	Boyutlar (WxLxH) mm	Kesim Aralığı	Makara Miktarı (Mt)	Fiyat (metre)
G	BL-NL-2001	3000 K	250	8x16	1MT	50 MT	5.10 \$
G	BL-NL-2002	4000 K	250	8x16	1MT	50 MT	5.10 \$
G	BL-NL-2003	6500 K	250	8x16	1MT	50 MT	5.10 \$
G	BL-NL-2004	KIRMIZI	10	8x16	1MT	50 MT	5.10 \$
G	BL-NL-2005	MAVİ	18	8x16	1MT	50 MT	5.10 \$
G	BL-NL-2006	YEŞİL	30	8x16	1MT	50 MT	5.10 \$
G	BL-NL-2007	AMBER	250	8x16	1MT	50 MT	5.10 \$
G	BL-NL-2001-25	3000 K	250	8x16	1MT	25 MT	5.10 \$
G	BL-NL-2002-25	4000 K	250	8x16	1MT	25 MT	5.10 \$
G	BL-NL-2003-25	6500 K	250	8x16	1MT	25 MT	5.10 \$
G	BL-NL-2004-25	KIRMIZI	10	8x16	1MT	25 MT	5.10 \$
G	BL-NL-2005-25	MAVİ	18	8x16	1MT	25 MT	5.10 \$
G	BL-NL-2006-25	YEŞİL	30	8x16	1MT	25 MT	5.10 \$
G	BL-NL-2007-25	AMBER	250	8x16	1MT	25 MT	5.10 \$
G	BL-NL-2001-5	3000 K	250	8x16	1MT	5 MT	5.10 \$
G	BL-NL-2002-5	4000 K	250	8x16	1MT	5 MT	5.10 \$
G	BL-NL-2003-5	6500 K	250	8x16	1MT	5 MT	5.10 \$
G	BL-NL-2004-5	KIRMIZI	10	8x16	1MT	5 MT	5.10 \$
G	BL-NL-2005-5	MAVİ	18	8x16	1MT	5 MT	5.10 \$
G	BL-NL-2006-5	YEŞİL	30	8x16	1MT	5 MT	5.10 \$
G	BL-NL-2007-5	AMBER	250	8x16	1MT	5 MT	5.10 \$

Enerji Verimliliği i Sınıfı	Ürün Kodu	Renk Sıcaklığı (K)	Işık Akısı (Lm)	Boyutlar (WxLxH) mm	Kesim Aralığı	Makara Miktarı (Mt)	Fiyat (metre)
G	BL-NL-3001	3000 K	200	6 x 12	2.5cm	5 Mt	4.10 \$
G	BL-NL-3002	4000 K	200	6 x 12	2.5cm	5 Mt	4.10 \$
G	BL-NL-3003	6500 K	200	6 x 12	2.5cm	5 Mt	4.10 \$
G	BL-NL-3004	KIRMIZI	20	6 x 12	2.5cm	5 Mt	4.10 \$
G	BL-NL-3005	MAVİ	60	6 x 12	2.5cm	5 Mt	4.10 \$
G	BL-NL-3006	YEŞİL	36	6 x 12	2.5cm	5 Mt	4.10 \$
G	BL-NL-3007	AMBER	170	6 x 12	2.5cm	5 Mt	4.10 \$
G	BL-NL-3001-25	3000 K	200	6 x 12	2.5cm	25 Mt	4.10 \$
G	BL-NL-3002-25	4000 K	200	6 x 12	2.5cm	25 Mt	4.10 \$
G	BL-NL-3003-25	6500 K	200	6 x 12	2.5cm	25 Mt	4.10 \$
G	BL-NL-3004-25	KIRMIZI	20	6 x 12	2.5cm	25 Mt	4.10 \$
G	BL-NL-3005-25	MAVİ	60	6 x 12	2.5cm	25 Mt	4.10 \$
G	BL-NL-3006-25	YEŞİL	36	6 x 12	2.5cm	25 Mt	4.10 \$
G	BL-NL-3007-25	AMBER	170	6 x 12	2.5cm	25 Mt	4.10 \$
G	BL-NL-3001-50	3000 K	200	6 x 12	2.5cm	50 Mt	4.10 \$
G	BL-NL-3002-50	4000 K	200	6 x 12	2.5cm	50 Mt	4.10 \$
G	BL-NL-3003-50	6500 K	200	6 x 12	2.5cm	50 Mt	4.10 \$
G	BL-NL-3004-50	KIRMIZI	20	6 x 12	2.5cm	50 Mt	4.10 \$
G	BL-NL-3005-50	MAVİ	60	6 x 12	2.5cm	50 Mt	4.10 \$
G	BL-NL-3006-50	YEŞİL	36	6 x 12	2.5cm	50 Mt	4.10 \$
G	BL-NL-3007-50	AMBER	170	6 x 12	2.5cm	50 Mt	4.10 \$

220V 240 LED CHIP SEFFAF KILIFLI SERİT LED
220V 240 LED CHIP TRANSPARENT SLEEVE LED STRIP



Ürün Kodu	Giriş Voltajı	Renk Sıcaklığı (K)	Işık Akısı (Lm)	IP Derecesi	Koli Miktarı (Mt)	Fiyat (metre)
BL-SL-4005	220-240V AC	3000 K	960 lm/m	IP65	100mt	3,20 \$
BL-SL-4006	220-240V AC	4000 K		IP65	100mt	3,20 \$
BL-SL-4007	220-240V AC	6500 K		IP65	100mt	3,20 \$
BL-SL-4008	220-240V AC	AMBER		IP65	100mt	3,20 \$

220V 120 LED CHIP SEFFAF KILIFLI SERİT LED
220V 120 LED CHIP TRANSPARENT SLEEVE LED STRIP



Ürün Kodu	Giriş Voltajı	Renk Sıcaklığı (K)	Işık Akısı (Lm)	IP Derecesi	Koli Miktarı (Mt)	Fiyat (metre)
BL-SL-4001	220-240V AC	3000 K	700 lm/m	IP65	100mt	2,10 \$
BL-SL-4002	220-240V AC	4000 K		IP65	100mt	2,10 \$
BL-SL-4003	220-240V AC	6500 K		IP65	100mt	2,10 \$
BL-SL-4004	220-240V AC	AMBER		IP65	100mt	2,10 \$

12V 240 CHIP'LI SERİT LED
12V 240 LED CHIP LED STRIP



Ürün Kodu	Giriş Voltajı	Renk Sıcaklığı (K)	Işık Akısı (Lm)	Kutu Miktarı (Mt)	Koli Miktarı (Mt)	Fiyat (metre)
BL-SL-2005	DC 12 V	3000 K	1200 lm/m	5mt	250mt	1,90 \$
BL-SL-2006	DC 12 V	4000 K		5mt	250mt	1,90 \$
BL-SL-2007	DC 12 V	6500 K		5mt	250mt	1,90 \$
BL-SL-2008	DC 12 V	AMBER		5mt	250mt	1,90 \$

12V 120 CHIP'LI SERİT LED
12V 120 LED CHIP LED STRIP

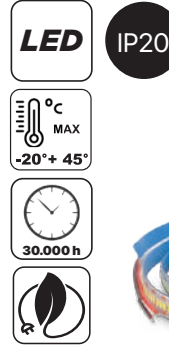

Ürün Kodu	Giriş Voltajı	Renk Sıcaklığı (K)	Işık Akısı (Lm)	Kutu Miktarı (Mt)	Koli Miktarı (Mt)	Fiyat (metre)
BL-SL-2001	DC 12 V	3000 K	800lm/m	5mt	250mt	1,20 \$
BL-SL-2002	DC 12 V	4000 K		5mt	250mt	1,20 \$
BL-SL-2003	DC 12 V	6500 K		5mt	250mt	1,20 \$
BL-SL-2004	DC 12 V	AMBER		5mt	250mt	1,20 \$

12V COB LED SERİT LED
12V COB LED STRIP



Ürün Kodu	Giriş Voltajı	Renk Sıcaklığı (K)	Işık Akısı (Lm)	Kutu Miktarı (Mt)	Koli Miktarı (Mt)	Fiyat (metre)
BL-SL-5001	DC 12 V	3000 K	960 lm/m	5mt	250mt	3,00 \$
BL-SL-5002	DC 12 V	4000 K		5mt	250mt	3,00 \$
BL-SL-5003	DC 12 V	6500 K		5mt	250mt	3,00 \$
BL-SL-5004	DC 12 V	AMBER		5mt	250mt	3,00 \$

240 LED CHIP KAPLAMALI COB LED SERİT
240 CHIP COB LED STRIP



Ürün Kodu	Giriş Voltajı	Renk Sıcaklığı (K)	Işık Akısı (Lm)	IP Derecesi	Koli Miktarı (Mt)	Fiyat (metre)
BL-SL-3001	220-240V AC	3000 K	320 lm/m	IP65	100mt	4,50 \$
BL-SL-3002	220-240V AC	4000 K		IP65	100mt	4,50 \$
BL-SL-3003	220-240V AC	6500 K		IP65	100mt	4,50 \$
BL-SL-3004	220-240V AC	AMBER		IP65	100mt	4,50 \$

NEON STRIP LED 220V KONNEKTÖR
NEON STRIP LED 220V CONNECTOR



voltage
220 - 240V
AC
50 - 60 Hz

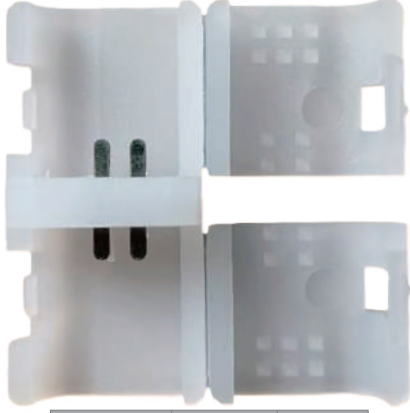

YENİ
ÜRÜN

Ürün Kodu	Koli Adedi	Fiyat
132-2399	25	1,00 \$

NEON ŞERİT LED 220V BAĞLANTI FİŞİ
220V NEON STRIP LED CONNECTOR PLUG



voltage
220 - 240V
AC
50 - 60 Hz



YENİ
ÜRÜN

Ürün Kodu	Koli Adedi	Fiyat
132-2386	25	2,30 \$

ŞEFFAF KILIFLI LED ŞERİT 220V 120 CHIP BAĞLANTI FİŞİ
220V TRANSPARENT SLEEVE LED STRIP 120 CHIP CONNECTOR PLUG



voltage
220 - 240V
AC
50 - 60 Hz



YENİ
ÜRÜN

Ürün Kodu	Koli Adedi	Fiyat
132-2404	25	1,70 \$

ŞEFFAF KILIFLI LED ŞERİT 220V 240 CHIP BAĞLANTI FİŞİ
220V TRANSPARENT SLEEVE LED STRIP 240 CHIP CONNECTOR PLUG



voltage
220 - 240V
AC
50 - 60 Hz



YENİ
ÜRÜN

Ürün Kodu	Koli Adedi	Fiyat
132-2403	25	1,90 \$

NEON ŞERİT LED 12V BAĞLANTI FİŞİ
12V NEON STRIP LED CONNECTOR PLUG



YENİ
ÜRÜN



Ürün Kodu	Koli Adedi	Fiyat
132-2394	25	1,60 \$

NEON ŞERİT LED 12V BAĞLANTI KONNEKTÖR
12V NEON STRIP LED CONNECTOR



YENİ
ÜRÜN



Ürün Kodu	Koli Adedi	Fiyat
132-2402	25	0,90 \$

Etanj Armatürler



LED LEVEL ETANJ ARMATÜR
LED LEVEL WATERPROOF ARMATURE

LED LEVEL ETANJ ARMATÜR TSE
LED LEVEL WATERPROOF ARMATURE TSE

IP65

voltage
85 - 265V
AC
50 - 60 Hz

LED

OSRAM
LEDs
Included



IP65

voltage
85 - 265V
AC
50 - 60 Hz

LED

OSRAM
LEDs
Included



Enerji Verimliliği Sınıfı	Ürün Kodu	Güç (W)	Renk Sıcaklığı (K)	Işık Akısı (Lm)	Ürün Ölçüsü WxLxH mm	Opsiyonlar	Fiyat
A F	BL-E1-0009	15W	4000 K	1500	44x600x64	-	20,40 \$
A F	BL-E1-0013		6500 K		44x600x64	-	20,40 \$
A F	BL-E1-0009-RS		4000 K		44x600x64	Radar Sensörlü	30,50 \$
A F	BL-E1-0013-RS		6500 K		44x600x64	Radar Sensörlü	30,50 \$
A F	BL-E1-0009-3H		4000 K		44x600x64	3 Saat Acil Kit	54,30 \$
A F	BL-E1-0013-3H		6500 K		44x600x64	3 Saat Acil Kit	54,30 \$
A F	BL-E1-0009-RS-3H		4000 K		44x600x64	Radar Sensörlü 3 Saat Acil Kit	60,20 \$
A F	BL-E1-0013-RS-3H		6500 K		44x600x64	Radar Sensörlü 3 Saat Acil Kit	60,20 \$
A F	BL-E1-0011	30W	4000 K	3000	44x1200x64	-	32,40 \$
A F	BL-E1-0015		6500 K		44x1200x64	-	32,40 \$
A F	BL-E1-0011-RS		4000 K		44x1200x64	Radar Sensörlü	66,70 \$
A F	BL-E1-0015-RS		6500 K		44x1200x64	Radar Sensörlü	66,70 \$
A F	BL-E1-0011-3H		4000 K		44x1200x64	3 Saat Acil Kit	67,70 \$
A F	BL-E1-0015-3H		6500 K		44x1200x64	3 Saat Acil Kit	67,70 \$
A F	BL-E1-0011-RS-3H		4000 K		44x1200x64	Radar Sensörlü 3 Saat Acil Kit	95,80 \$
A F	BL-E1-0015-RS-3H		6500 K		44x1200x64	Radar Sensörlü 3 Saat Acil Kit	95,80 \$

Enerji Verimliliği Sınıfı	Ürün Kodu	Güç (W)	Renk Sıcaklığı (K)	Işık Akısı (Lm)	Ürün Ölçüsü WxLxH mm	Opsiyonlar	Fiyat
A F	BLT-E1-0009	15W	4000 K	1500	44x600x64	-	27,00 \$
A F	BLT-E1-0013		6500 K		44x600x64	-	27,00 \$
A F	BLT-E1-0009-RS		4000 K		44x600x64	Radar Sensörlü	60,80 \$
A F	BLT-E1-0013-RS		6500 K		44x600x64	Radar Sensörlü	60,80 \$
A F	BLT-E1-0009-3H		4000 K		44x600x64	3 Saat Acil Kit	58,70 \$
A F	BLT-E1-0013-3H		6500 K		44x600x64	3 Saat Acil Kit	58,70 \$
A F	BLT-E1-0009-RS-3H		4000 K		44x600x64	Radar Sensörlü 3 Saat Acil Kit	93,10 \$
A F	BLT-E1-0013-RS-3H		6500 K		44x600x64	Radar Sensörlü 3 Saat Acil Kit	93,10 \$
A F	BLT-E1-0011	30W	4000 K	3000	44x1200x64	-	36,80 \$
A F	BLT-E1-0015		6500 K		44x1200x64	-	36,80 \$
A F	BLT-E1-0011-RS		4000 K		44x1200x64	Radar Sensörlü	73,50 \$
A F	BLT-E1-0015-RS		6500 K		44x1200x64	Radar Sensörlü	73,50 \$
A F	BLT-E1-0011-3H		4000 K		44x1200x64	3 Saat Acil Kit	70,70 \$
A F	BLT-E1-0015-3H		6500 K		44x1200x64	3 Saat Acil Kit	70,70 \$
A F	BLT-E1-0011-RS-3H		4000 K		44x1200x64	Radar Sensörlü 3 Saat Acil Kit	109,20 \$
A F	BLT-E1-0015-RS-3H		6500 K		44x1200x64	Radar Sensörlü 3 Saat Acil Kit	109,20 \$

LED ELIPS ETANJ ARMATÜR
LED ELIPS WATERPROOF ARMATURE

LED ELIPS ETANJ ARMATÜR TSE
LED ELIPS WATERPROOF ARMATURE TSE

IP65

voltage
85 - 265V
AC
50 - 60 Hz

LED

OSRAM
LEDs
Included



50.000 h

°C
MAX
-20°+ 45°

IK 09

12 Adet



IP65

voltage
85 - 265V
AC
50 - 60 Hz

LED

OSRAM
LEDs
Included



50.000 h

°C
MAX
-20°+ 45°

IK 09

12 Adet



Enerji Verimliliği Sınıfı	Ürün Kodu	Güç (W)	Renk Sıcaklığı (K)	Işık Akısı (Lm)	Ürün Ölçüsü WxLxH mm	Opsiyonlar	Fiyat	
A	BL-E1-0010	20W	4000 K	2000	75x600x75	-	21,40 \$	
F	BL-E1-0014		6500 K		75x600x75	-	21,40 \$	
A	BL-E1-0010-RS		4000 K		75x600x75	Radar Sensörlü	32,20 \$	
F	BL-E1-0014-RS		6500 K		75x600x75	Radar Sensörlü	32,20 \$	
A	BL-E1-0010-3H		4000 K		75x600x75	3 Saat Acil Kit	57,00 \$	
F	BL-E1-0014-3H		6500 K		75x600x75	3 Saat Acil Kit	57,00 \$	
A	BL-E1-0010-RS-3H		4000 K		75x600x75	Radar Sensörlü 3 Saat Acil Kit	63,60 \$	
F	BL-E1-0014-RS-3H		6500 K		75x600x75	Radar Sensörlü 3 Saat Acil Kit	63,60 \$	
A	BL-E1-0012		40W	4000 K	4000	75x1200x75	-	34,20 \$
F	BL-E1-0016			6500 K		75x1200x75	-	34,20 \$
A	BL-E1-0012-RS			4000 K		75x1200x75	Radar Sensörlü	70,40 \$
F	BL-E1-0016-RS			6500 K		75x1200x75	Radar Sensörlü	70,40 \$
A	BL-E1-0012-3H			4000 K		75x1200x75	3 Saat Acil Kit	71,40 \$
F	BL-E1-0016-3H			6500 K		75x1200x75	3 Saat Acil Kit	71,40 \$
A	BL-E1-0012-RS-3H			4000 K		75x1200x75	Radar Sensörlü 3 Saat Acil Kit	108,10 \$
F	BL-E1-0016-RS-3H			6500 K		75x1200x75	Radar Sensörlü 3 Saat Acil Kit	108,10 \$

Enerji Verimliliği Sınıfı	Ürün Kodu	Güç (W)	Renk Sıcaklığı (K)	Işık Akısı (Lm)	Ürün Ölçüsü WxLxH mm	Opsiyonlar	Fiyat	
A	BLT-E1-0010	20W	4000 K	2000	75x600x75	-	28,50 \$	
F	BLT-E1-0014		6500 K		75x600x75	-	28,50 \$	
A	BLT-E1-0010-RS		4000 K		75x600x75	Radar Sensörlü	63,80 \$	
F	BLT-E1-0014-RS		6500 K		75x600x75	Radar Sensörlü	63,80 \$	
A	BLT-E1-0010-3H		4000 K		75x600x75	3 Saat Acil Kit	62,20 \$	
F	BLT-E1-0014-3H		6500 K		75x600x75	3 Saat Acil Kit	62,20 \$	
A	BLT-E1-0010-RS-3H		4000 K		75x600x75	Radar Sensörlü 3 Saat Acil Kit	97,20 \$	
F	BLT-E1-0014-RS-3H		6500 K		75x600x75	Radar Sensörlü 3 Saat Acil Kit	97,20 \$	
A	BLT-E1-0012		40W	4000 K	4000	75x1200x75	-	39,00 \$
F	BLT-E1-0016			6500 K		75x1200x75	-	39,00 \$
A	BLT-E1-0012-RS			4000 K		75x1200x75	Radar Sensörlü	77,90 \$
F	BLT-E1-0016-RS			6500 K		75x1200x75	Radar Sensörlü	77,90 \$
A	BLT-E1-0012-3H			4000 K		75x1200x75	3 Saat Acil Kit	74,70 \$
F	BLT-E1-0016-3H			6500 K		75x1200x75	3 Saat Acil Kit	74,70 \$
A	BLT-E1-0012-RS-3H			4000 K		75x1200x75	Radar Sensörlü 3 Saat Acil Kit	112,90 \$
F	BLT-E1-0016-RS-3H			6500 K		75x1200x75	Radar Sensörlü 3 Saat Acil Kit	112,90 \$



LYRA ETANJ
LYRA ETANJ

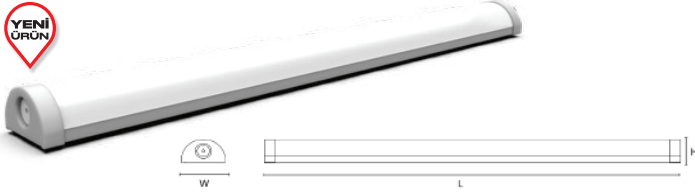

Enerji Verimliliği Sınıfı	Ürün Kodu	Güç (W)	Renk Sıcaklığı (K)	Işık Akısı (Lm)	Ürün Ölçüsü WxLxH mm	Fiyat
A++ F	BL-EE-0001	20W	6500K	2000	63 x 600 x 37	18,60 \$
A++ F	BL-EE-0002		4000K		63 x 600 x 37	18,60 \$
A++ F	BL-EE-0003		3000K		63 x 600 x 37	18,60 \$
A++ F	BL-EE-0004	40W	3000K	4000	63 x 1200 x 37	28,90 \$
A++ F	BL-EE-0005		4000K		63 x 1200 x 37	28,90 \$
A++ F	BL-EE-0006		6500K		63 x 1200 x 37	28,90 \$

ORTA ETANJ
MID ETANJ

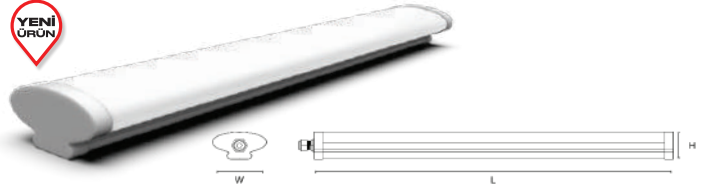

Enerji Verimliliği Sınıfı	Ürün Kodu	Güç (W)	Renk Sıcaklığı (K)	Işık Akısı (Lm)	Ürün Ölçüsü WxLxH mm	Fiyat
A++ F	BL-ME-0001	20W	6500K	2000	91,8 x 600 x 50,6	18,80 \$
A++ F	BL-ME-0002		4000K		91,8 x 600 x 50,6	18,80 \$
A++ F	BL-ME-0003		3000K		91,8 x 600 x 50,6	18,80 \$
A++ F	BL-ME-0004	40W	6500K	4000	91,8 x 1200 x 50,6	32,40 \$
A++ F	BL-ME-0005		4000K		91,8 x 1200 x 50,6	32,40 \$
A++ F	BL-ME-0006		3000K		91,8 x 1200 x 50,6	32,40 \$

KÖŞE ETANJ
CORNER ETANJ



Enerji Verimliliği Sınıfı	Ürün Kodu	Güç (W)	Renk Sıcaklığı (K)	Işık Akısı (Lm)	Ürün Ölçüsü WxLxH mm	Fiyat
A++ F	BL-KE-0001	20W	6500K	2000	79,4 x 600 x 56,8	18,60 \$
A++ F	BL-KE-0002		4000K		79,4 x 600 x 56,9	18,60 \$
A++ F	BL-KE-0003		3000K		79,4 x 600 x 56,10	18,60 \$
A++ F	BL-KE-0004	40W	3000K	4000	79,4 x 1200 x 56,8	32,30 \$
A++ F	BL-KE-0005		4000K		79,4 x 1200 x 56,9	32,30 \$
A++ F	BL-KE-0006		6500K		79,4 x 1200 x 56,10	32,30 \$

PREMIUM ETANJ
PREMIUM ETANJ

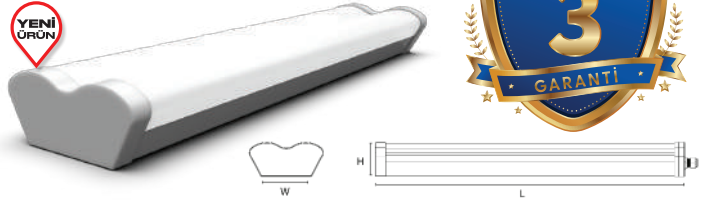

Enerji Verimliliği Sınıfı	Ürün Kodu	Güç (W)	Renk Sıcaklığı (K)	Işık Akısı (Lm)	Ürün Ölçüsü WxLxH mm	Fiyat
A++ F	BL-PE-0001	40W	6500K	4800	146 x 600 x 67	40,10 \$
A++ F	BL-PE-0002		4000K		146 x 600 x 67	40,10 \$
A++ F	BL-PE-0003		3000K		146 x 600 x 67	40,10 \$
A++ F	BL-PE-0004	60W	6500K	7200	146 x 1200 x 67	58,90 \$
A++ F	BL-PE-0005		4000K		146 x 1200 x 67	58,90 \$
A++ F	BL-PE-0006		3000K		146 x 1200 x 67	58,90 \$
A++ F	BL-PE-0007	80W	3000K	9600	146 x 1200 x 67	66,80 \$
A++ F	BL-PE-0008		4000K		146 x 1200 x 67	66,80 \$
A++ F	BL-PE-0009		6500K		146 x 1200 x 67	66,80 \$

T5 Tube Armatürler



IP20

voltage
85 - 265V
AC
50 - 60 Hz

30.000 h

°C
MAX
-20° + 45°

IK 02

20 Adet

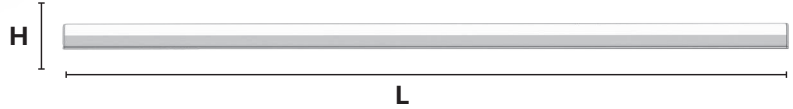
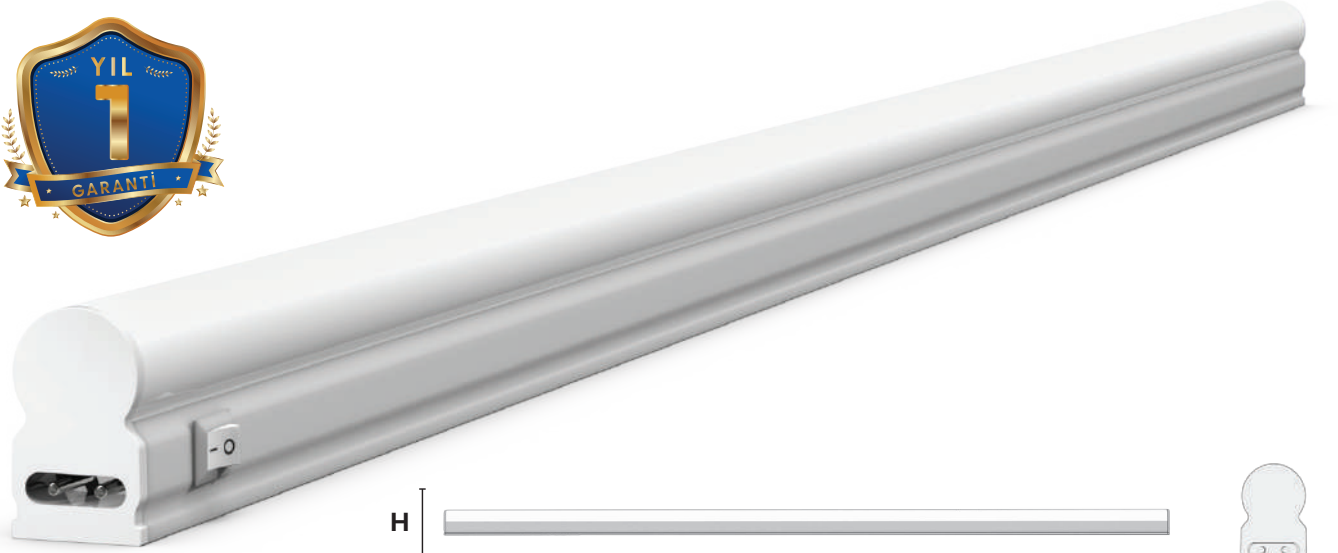

Enerji Verimliliği Sınıfı	Ürün Kodu	Güç (W)	Renk Sıcaklığı (K)	Işık Akısı (Lm)	Ürün Ölçüsü WxLxH mm	Fiyat
A++ F	BL-TB-0001	4W	6500 K	380	25 x 300 x 35	8,10 \$
	BL-TB-0002		4000 K		25 x 300 x 35	8,10 \$
	BL-TB-0003		3000 K		25 x 300 x 35	8,10 \$
A++ F	BL-TB-0004	8W	6500 K	760	25 x 600 x 35	10,00 \$
	BL-TB-0005		4000 K		25 x 600 x 35	10,00 \$
	BL-TB-0006		3000 K		25 x 600 x 35	10,00 \$
A++ F	BL-TB-0007	12W	6500 K	1150	25 x 900 x 35	12,00 \$
	BL-TB-0008		4000 K		25 x 900 x 35	12,00 \$
	BL-TB-0009		3000 K		25 x 900 x 35	12,00 \$
A++ F	BL-TB-0010	16W	6500 K	1500	25 x 1200 x 35	13,40 \$
	BL-TB-0011		4000 K		25 x 1200 x 35	13,40 \$
	BL-TB-0012		3000 K		25 x 1200 x 35	13,40 \$

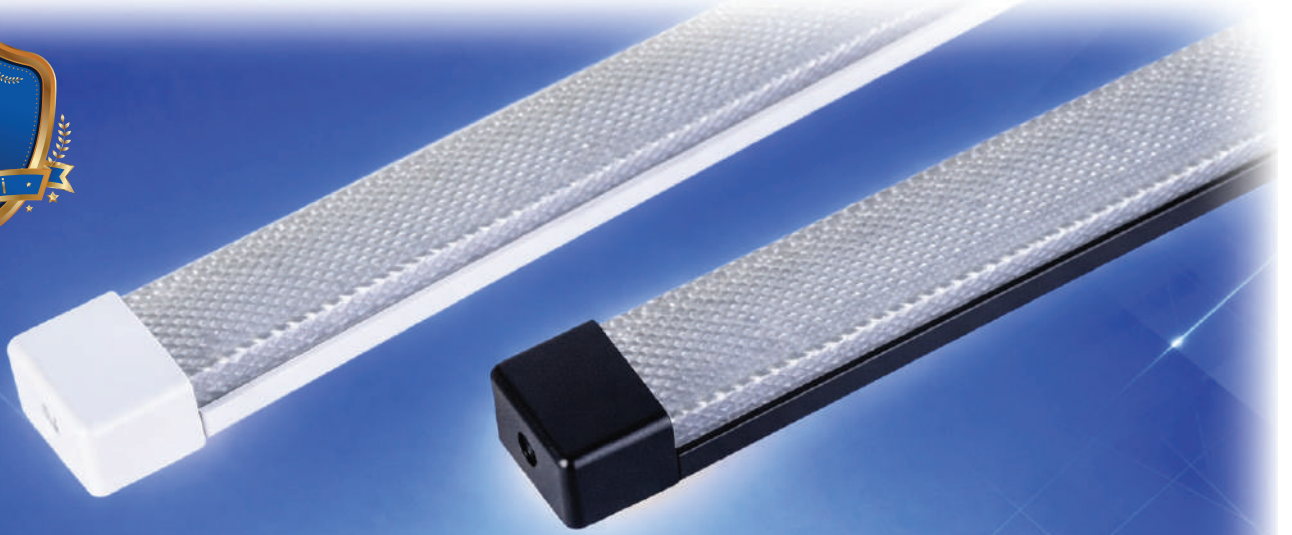

Kristal Bant Armatür

Modern Mimari İçin Estetik ve Verimli Çözümler

KRİSTAL BANT ARMATÜR-Beyaz
CRYSTAL BATTEN ARMATURE-White

KRİSTAL BANT ARMATÜR-Siyah
CRYSTAL BATTEN ARMATURE-Black

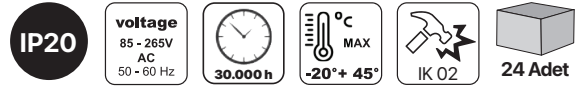
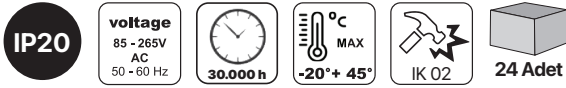
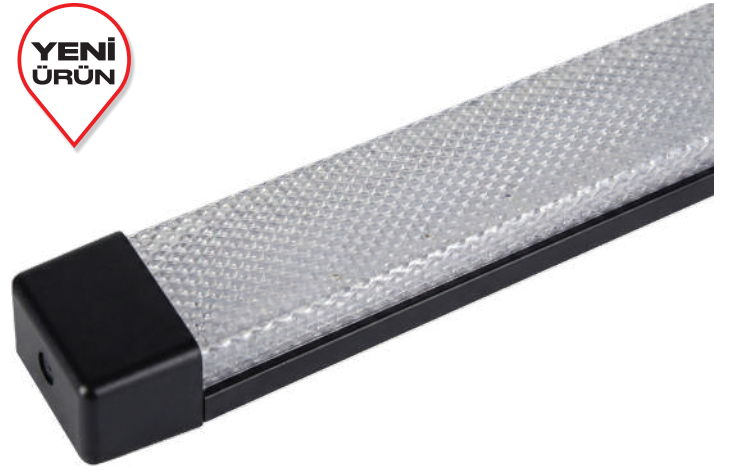

Enerji Verimliliği Sınıfı	Ürün Kodu	Güç (W)	Renk Sıcaklığı (K)	Işık Akısı (Lm)	Ürün Ölçüsü WxLxH mm	Fiyat
A	BL-KB-0001	80W	3000 K	5600	76x1200x27	14,80 \$
B	BL-KB-0002		4000 K		76x1200x27	14,80 \$
C	BL-KB-0003		6500 K		76x1200x27	14,80 \$
A	BL-KB-0004	100W	3000 K	7000	76x1200x27	20,10 \$
B	BL-KB-0005		4000 K		76x1200x27	20,10 \$
C	BL-KB-0006		6500 K		76x1200x27	20,10 \$

Enerji Verimliliği Sınıfı	Ürün Kodu	Güç (W)	Renk Sıcaklığı (K)	Işık Akısı (Lm)	Ürün Ölçüsü WxLxH mm	Fiyat
A	BL-KB-0001-S	80W	3000 K	5600	76x1200x27	16,00 \$
B	BL-KB-0002-S		4000 K		76x1200x27	16,00 \$
C	BL-KB-0003-S		6500 K		76x1200x27	16,00 \$
A	BL-KB-0004-S	100W	3000 K	7000	76x1200x27	21,30 \$
B	BL-KB-0005-S		4000 K		76x1200x27	21,30 \$
C	BL-KB-0006-S		6500 K		76x1200x27	21,30 \$

Gold Serisi Projektörler

Üstün Performans ve Estetik Aydınlatma Çözümleri

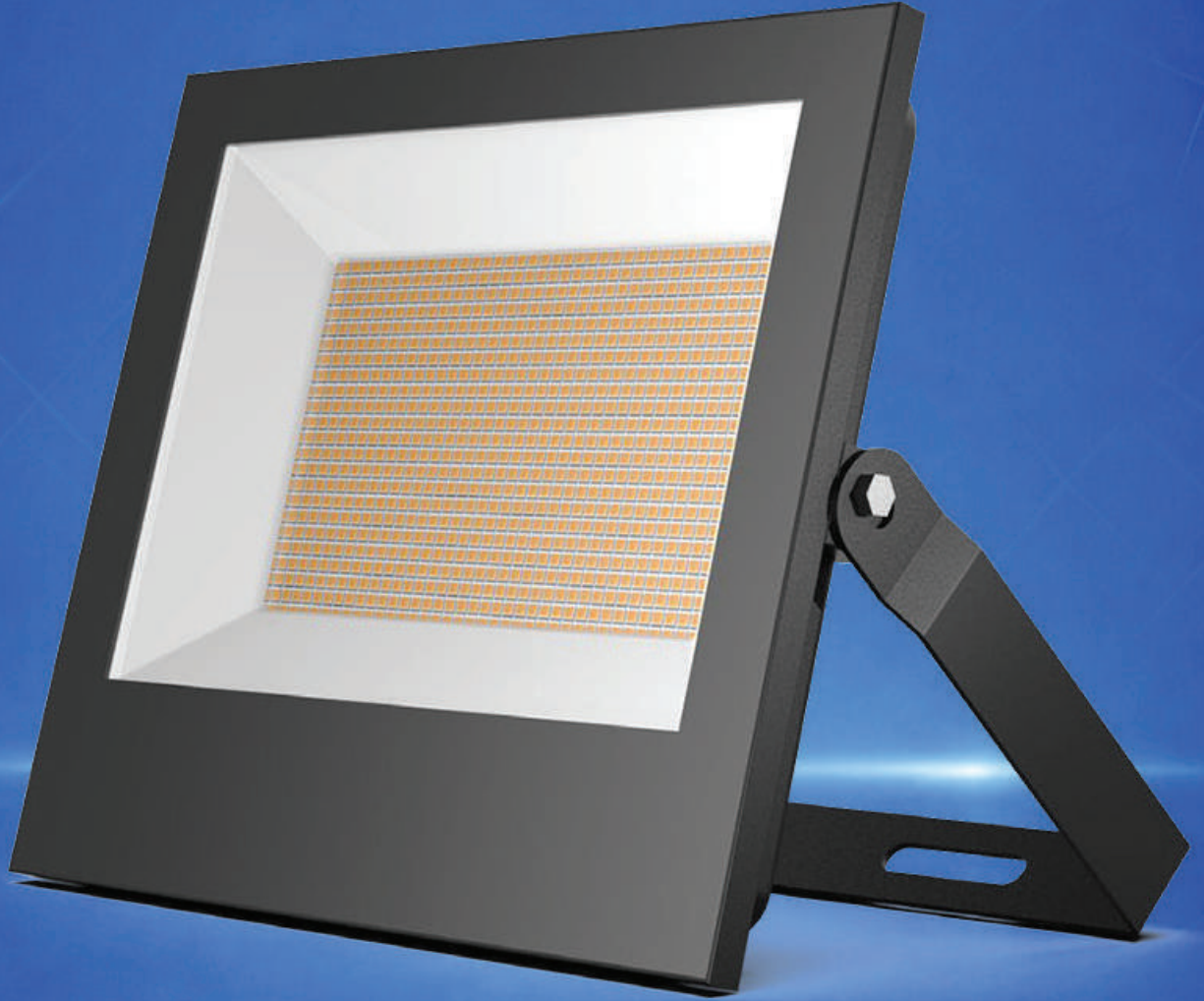



Enerji Verimliliği Sınıfı	Ürün Kodu	Güç (W)	Renk Sıcaklığı (K)	Işık Akısı (Lm)	Ürün Ölçüsü WxLxH mm	Koli Adeti	Fiyat
A++ F	BL-P4-0001	10W	3000 K	800	69 x 98 x 25	36	8,20 \$
	BL-P4-0003		6500 K		69 x 98 x 25		
A++ F	BL-P4-0004	20W	3000 K	1600	92 x 123 x 28	36	11,60 \$
	BL-P4-0006		6500 K		92 x 123 x 28		
A++ F	BL-P4-0007	30W	3000 K	2400	117 x 157 x 28	32	16,90 \$
	BL-P4-0009		6500 K		117 x 157 x 28		
A++ F	BL-P4-0010	50W	3000 K	4000	144 x 202 x 28	16	24,60 \$
	BL-P4-0012		6500 K		144 x 202 x 28		
A++ F	BL-P4-50GRN		YEŞİL/GREEN		144 x 202 x 28	16	34,60 \$
A++ F	BL-P4-0013	70W	3000 K	5600	186 x 241 x 28	10	30,20 \$
	BL-P4-0015		6500 K		186 x 241 x 28		
A++ F	BL-P4-0016	100W	3000 K	8000	206 x 266 x 30	10	44,80 \$
	BL-P4-0018		6500 K		206 x 266 x 30		
A++ F	BL-P4-100GRN		YEŞİL/GREEN		206 x 266 x 30	10	54,80 \$
A++ F	BL-P4-0019	150W	3000 K	12000	230 x 320 x 32	5	70,40 \$
	BL-P4-0021		6500 K		230 x 320 x 32		
A++ F	BL-P4-0022	200W	3000 K	16000	247 x 350 x 34	5	89,20 \$
	BL-P4-0024		6500 K		247 x 350 x 34		
A++ F	BL-P4-0025	300W	3000 K	24000	356 x 470 x 36.5	2	177,80 \$
	BL-P4-0027		6500 K		356 x 470 x 36.5		
A++ F	BL-P4-0028	400W	3000 K	32000	386 x 518 x 77	2	262,30 \$
	BL-P4-0030		6500 K		386 x 518 x 77		

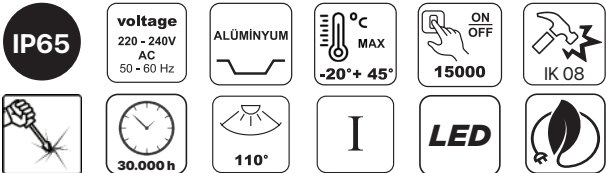
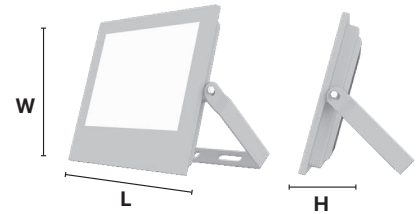

Platin Serisi Projektörler

Yüksek Performanslı, Güvenilir LED Dış Mekan Aydınlatması

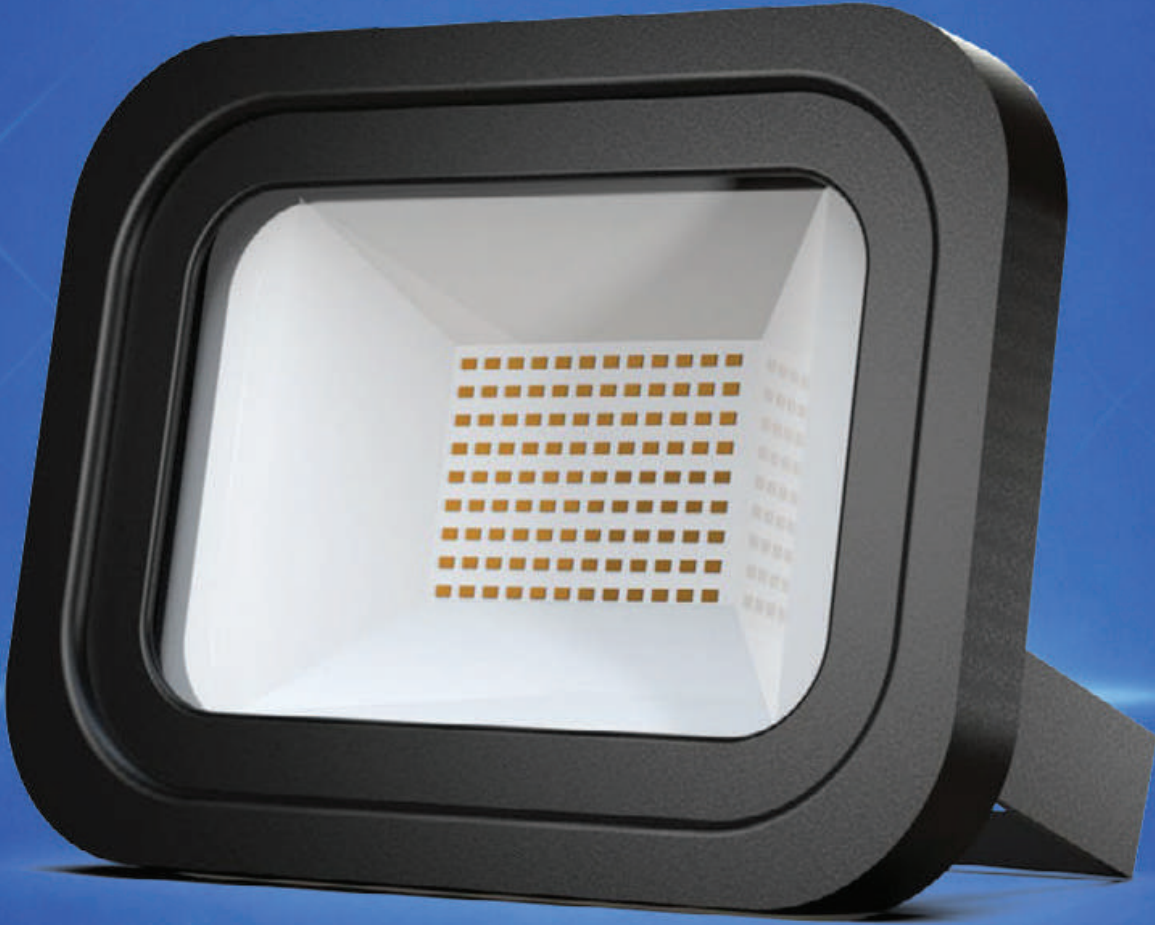

IP65

voltage
220 - 240V
AC
50 - 60 Hz



50.000 h



ALÜMİNYUM
°C MAX
-20°+ 45°



110°



ON
OFF
15000
IK 08



Enerji Verimliliği Sınıfı	Ürün Kodu	Güç (W)	Renk Sıcaklığı (K)	Işık Akısı (Lm)	Ürün Ölçüsü WxLxH mm	Koli Adeti	Fiyat
A	BL-P2-0001	10W	6500 K	800	87 x 115 x 32	32	11,70 \$
F	BL-P2-0002		4000 K		87 x 115 x 32	32	11,70 \$
G	BL-P2-0003		3000 K		87 x 115 x 32	32	11,70 \$
A	BL-P2-0004	20W	6500 K	1600	107 x 137 x 32	32	16,60 \$
F	BL-P2-0005		4000 K		107 x 137 x 32	32	16,60 \$
G	BL-P2-0006		3000 K		107 x 137 x 32	32	16,60 \$
A	BL-P2-0007	30W	6500 K	2400	140 x 180 x 33	16	24,90 \$
F	BL-P2-0008		4000 K		140 x 180 x 33	16	24,90 \$
G	BL-P2-0009		3000 K		140 x 180 x 33	16	24,90 \$
A	BL-P2-0010	50W	6500 K	4000	185 x 227 x 36	10	35,30 \$
F	BL-P2-0011		4000 K		185 x 227 x 36	10	35,30 \$
G	BL-P2-0012		3000 K		185 x 227 x 36	10	35,30 \$
A	BL-P2-0013	70W	6500 K	5600	240 x 290 x 40	5	59,00 \$
F	BL-P2-0014		4000 K		240 x 290 x 40	5	59,00 \$
G	BL-P2-0015		3000 K		240 x 290 x 40	5	59,00 \$
A	BL-P2-0016	100W	6500 K	8000	240 x 290 x 40	5	67,00 \$
F	BL-P2-0017		4000 K		240 x 290 x 40	5	67,00 \$
G	BL-P2-0018		3000 K		240 x 290 x 40	5	67,00 \$
A	BL-P2-0019	150W	6500 K	12000	290 x 370 x 61	3	115,80 \$
F	BL-P2-0020		4000 K		290 x 370 x 61	3	115,80 \$
G	BL-P2-0021		3000 K		290 x 370 x 61	3	115,80 \$
A	BL-P2-0022	200W	6500 K	16000	310 x 440 x 65	3	155,90 \$
F	BL-P2-0023		4000 K		310 x 440 x 65	3	155,90 \$
G	BL-P2-0024		3000 K		310 x 440 x 65	3	155,90 \$

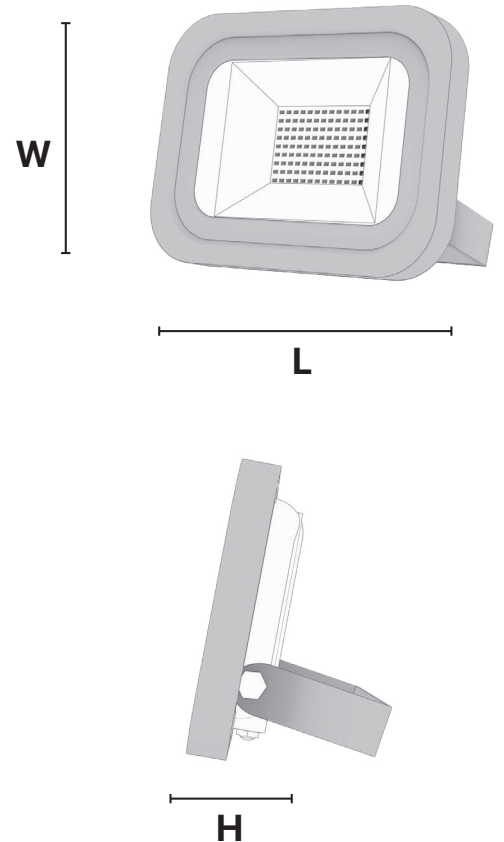

LED Yüksek Tavan Spot

Modern Tasarım, Yüksek Verimlilik.



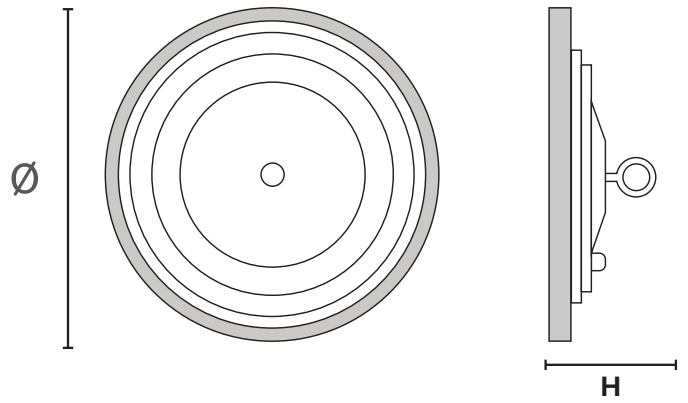
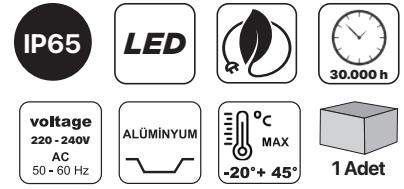

Enerji Verimliliği Sınıfı	Ürün Kodu	Güç (W)	Renk Sıcaklığı (K)	Işık Akısı (Lm)	Ürün Ölçüsü WxLxH mm	Fiyat
A G F	BL-HB-1001	100W	3000 K	10.000	270 X 42	60,10 \$
A G F	BL-HB-1002		6500 K		270 X 42	60,10 \$
A G F	BL-HB-1003	150W	3000 K	15.000	311 X 42	84,90 \$
A G F	BL-HB-1004		6500 K		311 X 42	84,90 \$
A G F	BL-HB-1005	200W	3000 K	20.000	383 X 42	112,70 \$
A G F	BL-HB-1006		6500 K		383 X 42	112,70 \$

Sokak Armatürleri

Enerji Verimli ve Sürdürülebilir Aydınlatma Çözümleri





IP65

LED

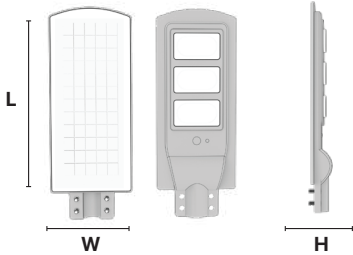

IP65

LED



3 Adet

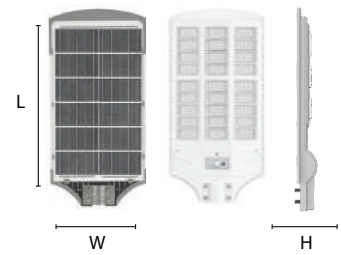

Ürün Kodu	Güç (W)	Renk Sıcaklığı (K)	Işık Akısı (Lm)	Ürün Ölçüsü WxLxH mm	Koli Adeti	Fiyat
BL-SP-0010	80W	3000 K	1150	240 x 725 x 45	10	96,40 \$
BL-SP-0011		4000 K		240 x 725 x 45	10	96,40 \$
BL-SP-0012		6500 K		240 x 725 x 45	10	96,40 \$
BL-SP-0013	100W	3000 K	1450	240 x 820 x 60	5	116,00 \$
BL-SP-0014		4000 K		240 x 820 x 60	5	116,00 \$
BL-SP-0015		6500 K		240 x 820 x 60	5	116,00 \$

Ürün Kodu	Güç (W)	Renk Sıcaklığı (K)	Işık Akısı (Lm)	Ürün Ölçüsü WxLxH mm	Fiyat
BL-SS-0001	200W	3000 K	2900	502 x 355 x 72	160,90 \$
BL-SS-0002		4000 K		503 x 355 x 72	160,90 \$
BL-SS-0003		6500 K		504 x 355 x 72	160,90 \$
BL-SS-0004	300W	3000 K	4350	505 x 355 x 72	183,40 \$
BL-SS-0005		4000 K		506 x 355 x 72	183,40 \$
BL-SS-0006		6500 K		507 x 355 x 72	183,40 \$



LED Sokak Aydınlatma

Armatürleri DOB

Yüksek Verimlilik, Dayanıklı Tasarım





IP65

LED



voltage
220 - 240V
AC
50 - 60 Hz

ALÜMİNYUM

°C
MAX
-20°+ 45°

4 Adet

YENİ
ÜRÜN

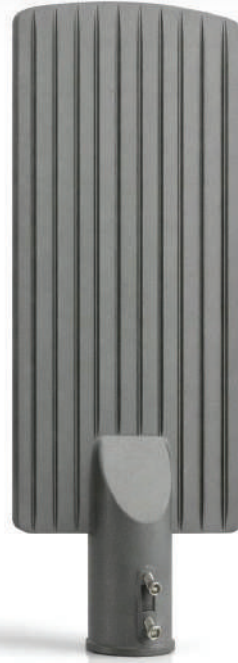

Enerji Verimliliği Sınıfı	Ürün Kodu	Güç (W)	Renk Sıcaklığı (K)	Işık Akısı (Lm)	Ürün Ölçüsü WxLxH mm	Konsol Çapı (Ø)	Fiyat
A F	BL-DOB-0001	100W	3000 K	12000	185 x 82 x 425	55	62,20 \$
A F	BL-DOB-0002		4000 K		185 x 82 x 425	55	62,20 \$
A F	BL-DOB-0003		6500 K		185 x 82 x 425	55	62,20 \$
A F	BL-DOB-0004	150W	3000 K	18000	225 x 82 x 516	55	93,50 \$
A F	BL-DOB-0005		4000 K		225 x 82 x 516	55	93,50 \$
A F	BL-DOB-0006		6500 K		225 x 82 x 516	55	93,50 \$
A F	BL-DOB-0007	200W	3000 K	24000	265 x 82 x 607	55	114,50 \$
A F	BL-DOB-0008		4000 K		265 x 82 x 607	55	114,50 \$
A F	BL-DOB-0009		6500 K		265 x 82 x 607	55	114,50 \$

Solar LED

Bahe Armatürleri

Enerji Tasarrufu Sağlayan Şık Bahe Aydınlatması





SOLAR LED BAHÇE ARMATÜRÜ (KARE)
SOLAR LED GARDEN ARMATURE (SQUARE)

SOLAR LED BAHÇE ARMATÜRÜ (YUVARLAK)
SOLAR LED GARDEN ARMATURE (ROUND)



IP65

LED



Ürün Kodu	Güç (W)	Renk Sıcaklığı (K)	Batarya Kapasitesi (mAh)	Işık Akısı (Lm)	Ürün Ölçüsü WxLxH mm	Fiyat
BL-SB-0001	3W	3000 K	2000	220	185x185x260	51,00 \$
BL-SB-0002		6500 K			185x185x260	51,00 \$
BL-SB-0003	5,5W	3000 K		400	200x200x260	58,10 \$
BL-SB-0004		6500 K			200x200x260	58,10 \$

Ürün Kodu	Güç (W)	Renk Sıcaklığı (K)	Batarya Kapasitesi (mAh)	Işık Akısı (Lm)	Ürün Ölçüsü ØxH mm	Fiyat
BL-SB-0005	3W	3000 K	2000	220	185x260	51,00 \$
BL-SB-0006		6500 K			185x260	51,00 \$
BL-SB-0007	5,5W	3000 K		400	200x260	58,10 \$
BL-SB-0008		6500 K			200x260	58,10 \$

Glop Aydınlatma Armatürleri

Modern, Estetik Ve Yüksek Verimlilik İçin Yenilikçi Çözümler



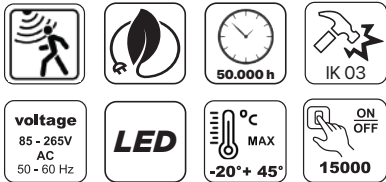
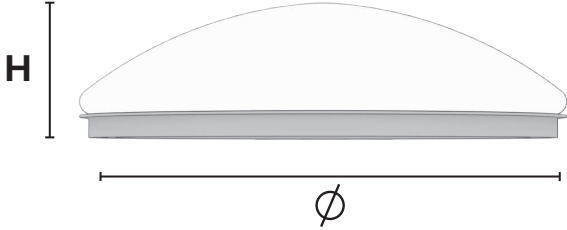

Enerji Verimliliği Sınıfı	Ürün Kodu	Güç (W)	Renk Sıcaklığı (K)	Işık Akısı (Lm)	Boyutlar (ØxH) mm	Opsiyonlar	Koli Adeti	Fiyat
A++ F	BL-G1-0002	12W	3000 K	1080	260 x 83	-	24	28,30 \$
A++ F	BL-G1-0014	12W	4000 K	1080	260 x 83	-	24	28,30 \$
A++ F	BL-G1-0008	12W	6500 K	1080	260 x 83	-	24	28,30 \$
A++ F	BL-G1-0002-RS	12W	3000 K	1080	260 x 83	Radar Sensörlü	24	37,90 \$
A++ F	BL-G1-0014-RS	12W	4000 K	1080	260 x 83	Radar Sensörlü	24	37,90 \$
A++ F	BL-G1-0008-RS	12W	6500 K	1080	260 x 83	Radar Sensörlü	24	37,90 \$
A++ F	BL-G1-0002-1H	12W	3000 K	1080	260 x 83	1 Saat Acil Kit	24	50,50 \$
A++ F	BL-G1-0014-1H	12W	4000 K	1080	260 x 83	1 Saat Acil Kit	24	50,50 \$
A++ F	BL-G1-0008-1H	12W	6500 K	1080	260 x 83	1 Saat Acil Kit	24	50,50 \$
A++ F	BL-G1-0002-RS-1H	12W	3000 K	1080	260 x 83	Radar Sensör & 1 Saat Acil Kit	24	55,10 \$
A++ F	BL-G1-0014-RS-1H	12W	4000 K	1080	260 x 83	Radar Sensör & 1 Saat Acil Kit	24	55,10 \$
A++ F	BL-G1-0008-RS-1H	12W	6500 K	1080	260 x 83	Radar Sensör & 1 Saat Acil Kit	24	55,10 \$
A++ F	BL-G1-0002-3H	12W	3000 K	1080	260 x 83	3 Saat Acil Kit	24	59,10 \$
A++ F	BL-G1-0014-3H	12W	4000 K	1080	260 x 83	3 Saat Acil Kit	24	59,10 \$
A++ F	BL-G1-0008-3H	12W	6500 K	1080	260 x 83	3 Saat Acil Kit	24	59,10 \$
A++ F	BL-G1-0002-RS-3H	12W	3000 K	1080	260 x 83	Radar Sensör & 3 Saat Acil Kit	24	65,80 \$
A++ F	BL-G1-0014-RS-3H	12W	4000 K	1080	260 x 83	Radar Sensör & 3 Saat Acil Kit	24	65,80 \$
A++ F	BL-G1-0008-RS-3H	12W	6500 K	1080	260 x 83	Radar Sensör & 3 Saat Acil Kit	24	65,80 \$
A++ F	BL-G1-0004	18W	3000 K	1620	330 x 96	-	12	34,90 \$
A++ F	BL-G1-0016	18W	4000 K	1620	330 x 96	-	12	34,90 \$
A++ F	BL-G1-0010	18W	6500 K	1620	330 x 96	-	12	34,90 \$
A++ F	BL-G1-0004-RS	18W	3000 K	1620	330 x 96	Radar Sensörlü	12	44,50 \$
A++ F	BL-G1-0016-RS	18W	4000 K	1620	330 x 96	Radar Sensörlü	12	44,50 \$
A++ F	BL-G1-0010-RS	18W	6500 K	1620	330 x 96	Radar Sensörlü	12	44,50 \$
A++ F	BL-G1-0004-1H	18W	3000 K	1620	330 x 96	1 Saat Acil Kit	12	57,10 \$
A++ F	BL-G1-0010-1H	18W	4000 K	1620	330 x 96	1 Saat Acil Kit	12	57,10 \$
A++ F	BL-G1-0016-1H	18W	6500 K	1620	330 x 96	1 Saat Acil Kit	12	57,10 \$
A++ F	BL-G1-0010-RS-1H	18W	3000 K	1620	330 x 96	Radar Sensör & 1 Saat Acil Kit	12	61,70 \$
A++ F	BL-G1-0004-RS-1H	18W	4000 K	1620	330 x 96	Radar Sensör & 1 Saat Acil Kit	12	61,70 \$
A++ F	BL-G1-0016-RS-1H	18W	6500 K	1620	330 x 96	Radar Sensör & 1 Saat Acil Kit	12	61,70 \$
A++ F	BL-G1-0004-3H	18W	3000 K	1620	330 x 96	3 Saat Acil Kit	12	65,70 \$
A++ F	BL-G1-0016-3H	18W	4000 K	1620	330 x 96	3 Saat Acil Kit	12	65,70 \$
A++ F	BL-G1-0010-3H	18W	6500 K	1620	330 x 96	3 Saat Acil Kit	12	65,70 \$
A++ F	BL-G1-0004-RS-3H	18W	3000 K	1620	330 x 96	Radar Sensör & 3 Saat Acil Kit	12	72,50 \$
A++ F	BL-G1-0016-RS-3H	18W	4000 K	1620	330 x 96	Radar Sensör & 3 Saat Acil Kit	12	72,50 \$
A++ F	BL-G1-0010-RS-3H	18W	6500 K	1620	330 x 96	Radar Sensör & 3 Saat Acil Kit	12	72,50 \$
A++ F	BL-G1-0006	24W	3000 K	2160	380 x 100	-	6	42,70 \$
A++ F	BL-G1-0018	24W	4000 K	2160	380 x 100	-	6	42,70 \$
A++ F	BL-G1-0012	24W	6500 K	2160	380 x 100	-	6	42,70 \$
A++ F	BL-G1-0006-RS	24W	3000 K	2160	380 x 100	Radar Sensörlü	6	52,20 \$
A++ F	BL-G1-0018-RS	24W	4000 K	2160	380 x 100	Radar Sensörlü	6	52,20 \$
A++ F	BL-G1-0012-RS	24W	6500 K	2160	380 x 100	Radar Sensörlü	6	52,20 \$
A++ F	BL-G1-0006-1H	24W	3000 K	2160	380 x 100	1 Saat Acil Kit	6	64,90 \$
A++ F	BL-G1-0018-1H	24W	4000 K	2160	380 x 100	1 Saat Acil Kit	6	64,90 \$
A++ F	BL-G1-0012-1H	24W	6500 K	2160	380 x 100	1 Saat Acil Kit	6	64,90 \$
A++ F	BL-G1-0006-RS-1H	24W	3000 K	2160	380 x 100	Radar Sensör & 1 Saat Acil Kit	6	69,50 \$
A++ F	BL-G1-0012-RS-1H	24W	4000 K	2160	380 x 100	Radar Sensör & 1 Saat Acil Kit	6	69,50 \$
A++ F	BL-G1-0018-RS-1H	24W	6500 K	2160	380 x 100	Radar Sensör & 1 Saat Acil Kit	6	69,50 \$
A++ F	BL-G1-0006-3H	24W	3000 K	2160	380 x 100	3 Saat Acil Kit	6	73,40 \$
A++ F	BL-G1-0018-3H	24W	4000 K	2160	380 x 100	3 Saat Acil Kit	6	73,40 \$
A++ F	BL-G1-0012-3H	24W	6500 K	2160	380 x 100	3 Saat Acil Kit	6	73,40 \$
A++ F	BL-G1-0006-RS-3H	24W	3000 K	2160	380 x 100	Radar Sensör & 3 Saat Acil Kit	6	80,20 \$
A++ F	BL-G1-0012-RS-3H	24W	4000 K	2160	380 x 100	Radar Sensör & 3 Saat Acil Kit	6	80,20 \$
A++ F	BL-G1-0018-RS-3H	24W	6500 K	2160	380 x 100	Radar Sensör & 3 Saat Acil Kit	6	80,20 \$

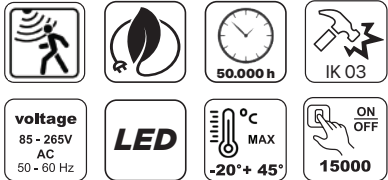
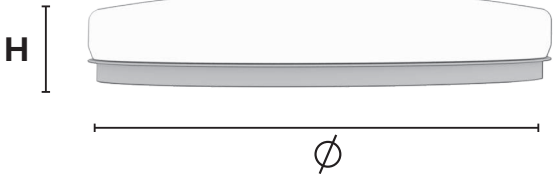

Enerji Verimliliği Sınıfı	Ürün Kodu	Güç (W)	Renk Sıcaklığı (K)	Işık Akısı (Lm)	Boyutlar (ØxH) mm	Opsiyonlar	Koli Adeti	Fiyat
A G F	BL-G1-0001	12W	3000 K	1080	260 x 83	-	24	28,30 \$
A G F	BL-G1-0013	12W	4000 K	1080	260 x 83	-	24	28,30 \$
A G F	BL-G1-0007	12W	6500 K	1080	260 x 83	-	24	28,30 \$
A G F	BL-G1-0001-RS	12W	3000 K	1080	260 x 83	Radar Sensörlü	24	37,90 \$
A G F	BL-G1-0013-RS	12W	4000 K	1080	260 x 83	Radar Sensörlü	24	37,90 \$
A G F	BL-G1-0007-RS	12W	6500 K	1080	260 x 83	Radar Sensörlü	24	37,90 \$
A G F	BL-G1-0001-RS-1H	12W	3000 K	1080	260 x 83	Radar Sensörlü 1 Saat Acil Kit	24	55,10 \$
A G F	BL-G1-0013-RS-1H	12W	4000 K	1080	260 x 83	Radar Sensörlü 1 Saat Acil Kit	24	55,10 \$
A G F	BL-G1-0007-RS-1H	12W	6500 K	1080	260 x 83	Radar Sensörlü 1 Saat Acil Kit	24	55,10 \$
A G F	BL-G1-0001-1H	12W	3000 K	1080	260 x 83	1 Saat Acil Kit	24	50,50 \$
A G F	BL-G1-0007-1H	12W	6500 K	1080	260 x 83	1 Saat Acil Kit	24	50,50 \$
A G F	BL-G1-0013-1H	12W	4000 K	1080	260 x 83	1 Saat Acil Kit	24	50,50 \$
A G F	BL-G1-0001-3H	12W	3000 K	1080	260 x 83	3 Saat Acil Kit	24	59,10 \$
A G F	BL-G1-0013-3H	12W	4000 K	1080	260 x 83	3 Saat Acil Kit	24	59,10 \$
A G F	BL-G1-0007-3H	12W	6500 K	1080	260 x 83	3 Saat Acil Kit	24	59,10 \$
A G F	BL-G1-0001-RS-3H	12W	3000 K	1080	260 x 83	Radar Sensörlü 3 Saat Acil Kit	24	65,80 \$
A G F	BL-G1-0013-RS-3H	12W	4000 K	1080	260 x 83	Radar Sensörlü 3 Saat Acil Kit	24	65,80 \$
A G F	BL-G1-0007-RS-3H	12W	6500 K	1080	260 x 83	Radar Sensörlü 3 Saat Acil Kit	24	65,80 \$
A G F	BL-G1-0003	18W	3000 K	1620	330 x 96	-	12	34,90 \$
A G F	BL-G1-0015	18W	4000 K	1620	330 x 96	-	12	34,90 \$
A G F	BL-G1-0009	18W	6500 K	1620	330 x 96	-	12	34,90 \$
A G F	BL-G1-0003-RS	18W	3000 K	1620	330 x 96	Radar Sensörlü	12	44,50 \$
A G F	BL-G1-0015-RS	18W	4000 K	1620	330 x 96	Radar Sensörlü	12	44,50 \$
A G F	BL-G1-0009-RS	18W	6500 K	1620	330 x 96	Radar Sensörlü	12	44,50 \$
A G F	BL-G1-0003-1H	18W	3000 K	1620	330 x 96	1 Saat Acil Kit	12	57,10 \$
A G F	BL-G1-0015-1H	18W	4000 K	1620	330 x 96	1 Saat Acil Kit	12	57,10 \$
A G F	BL-G1-0009-1H	18W	6500 K	1620	330 x 96	1 Saat Acil Kit	12	57,10 \$
A G F	BL-G1-0003-RS-1H	18W	3000 K	1620	330 x 96	Radar Sensörlü 1 Saat Acil Kit	12	61,70 \$
A G F	BL-G1-0015-RS-1H	18W	4000 K	1620	330 x 96	Radar Sensörlü 1 Saat Acil Kit	12	61,70 \$
A G F	BL-G1-0009-RS-1H	18W	6500 K	1620	330 x 96	Radar Sensörlü 1 Saat Acil Kit	12	61,70 \$
A G F	BL-G1-0003-3H	18W	3000 K	1620	330 x 96	3 Saat Acil Kit	12	65,70 \$
A G F	BL-G1-0015-3H	18W	4000 K	1620	330 x 96	3 Saat Acil Kit	12	65,70 \$
A G F	BL-G1-0009-3H	18W	6500 K	1620	330 x 96	3 Saat Acil Kit	12	65,70 \$
A G F	BL-G1-0003-RS-3H	18W	3000 K	1620	330 x 96	Radar Sensörlü 3 Saat Acil Kit	12	72,50 \$
A G F	BL-G1-0015-RS-3H	18W	4000 K	1620	330 x 96	Radar Sensörlü 3 Saat Acil Kit	12	72,50 \$
A G F	BL-G1-0009-RS-3H	18W	6500 K	1620	330 x 96	Radar Sensörlü 3 Saat Acil Kit	12	72,50 \$
A G F	BL-G1-0005-1H	24W	3000 K	2160	380 x 100	1 Saat Acil Kit	6	64,90 \$
A G F	BL-G1-0011-1H	24W	6500 K	2160	380 x 100	1 Saat Acil Kit	6	64,90 \$
A G F	BL-G1-0017-1H	24W	4000 K	2160	380 x 100	1 Saat Acil Kit	6	64,90 \$
A G F	BL-G1-0005	24W	3000 K	2160	380 x 100	-	6	42,70 \$
A G F	BL-G1-0017	24W	4000 K	2160	380 x 100	-	6	42,70 \$
A G F	BL-G1-0011	24W	6500 K	2160	380 x 100	-	6	42,70 \$
A G F	BL-G1-0005-RS	24W	3000 K	2160	380 x 100	Radar Sensörlü	6	52,20 \$
A G F	BL-G1-0017-RS	24W	4000 K	2160	380 x 100	Radar Sensörlü	6	52,20 \$
A G F	BL-G1-0011-RS	24W	6500 K	2160	380 x 100	Radar Sensörlü	6	52,20 \$
A G F	BL-G1-0005-RS-1H	24W	3000 K	2160	380 x 100	Radar Sensörlü 1 Saat Acil Kit	6	69,50 \$
A G F	BL-G1-0017-RS-1H	24W	4000 K	2160	380 x 100	Radar Sensörlü 1 Saat Acil Kit	6	69,50 \$
A G F	BL-G1-0011-RS-1H	24W	6500 K	2160	380 x 100	Radar Sensörlü 1 Saat Acil Kit	6	69,50 \$
A G F	BL-G1-0005-3H	24W	3000 K	2160	380 x 100	3 Saat Acil Kit	6	73,40 \$
A G F	BL-G1-0011-3H	24W	6500 K	2160	380 x 100	3 Saat Acil Kit	6	73,40 \$
A G F	BL-G1-0017-3H	24W	4000 K	2160	380 x 100	3 Saat Acil Kit	6	73,40 \$
A G F	BL-G1-0005-RS-3H	24W	3000 K	2160	380 x 100	Radar Sensörlü 3 Saat Acil Kit	6	80,20 \$
A G F	BL-G1-0017-RS-3H	24W	4000 K	2160	380 x 100	Radar Sensörlü 3 Saat Acil Kit	6	80,20 \$
A G F	BL-G1-0011-RS-3H	24W	6500 K	2160	380 x 100	Radar Sensörlü 3 Saat Acil Kit	6	80,20 \$



LED NEMLİYER YUVARLAK GLOP TAVAN ARMATÜR
LED NEMLİYER ROUND GLOBE CEILING ARMATURE

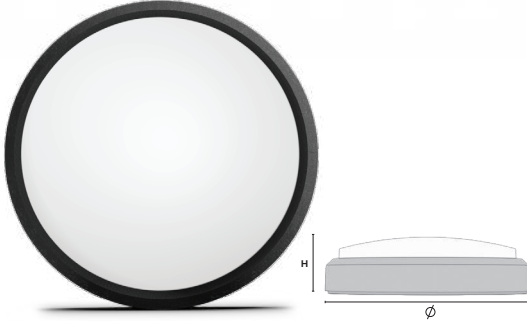
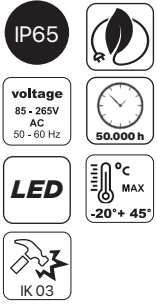

Enerji Verimliliği Sınıfı	Ürün Kodu	Güç (W)	Renk Sıcaklığı (K)	Işık Akısı (Lm)	Boyutlar (ØxH) mm	Renk	Koli Adedi	Fiyat
A	BL-G2-0002	12W	4000 K	1080	175 x 60	Beyaz/White	24	30,30 \$
A	BL-G2-0003	12W	6500 K	1080	175 x 60	Beyaz/White	24	30,30 \$
A	BL-G2-0005	15W	4000 K	1350	210 x 60	Beyaz/White	12	39,80 \$
A	BL-G2-0006	15W	6500 K	1350	210 x 60	Beyaz/White	12	39,80 \$
A	BL-G2-0008	12W	4000 K	1080	175 x 60	Siyah/Black	24	30,30 \$
A	BL-G2-0009	12W	6500 K	1080	175 x 60	Siyah/Black	24	30,30 \$
A	BL-G2-0011	15W	4000 K	1350	210 x 60	Siyah/Black	12	39,80 \$
A	BL-G2-0012	15W	6500 K	1350	210 x 60	Siyah/Black	12	39,80 \$

LED NEMLİYER OVAL GLOP TAVAN ARMATÜR
LED NEMLİYER OVAL GLOBE CEILING ARMATURE

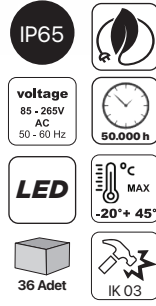

Enerji Verimliliği Sınıfı	Ürün Kodu	Güç (W)	Renk Sıcaklığı (K)	Işık Akısı (Lm)	Ürün Ölçüsü WxLxH mm	Renk	Fiyat
A	BL-G3-0002	12W	4000 K	1080	100x200x60	Beyaz/White	28,80 \$
A	BL-G3-0003	12W	6500 K	1080	100x200x60	Beyaz/White	28,80 \$
A	BL-G3-0005	15W	4000 K	1350	105x230x60	Beyaz/White	30,90 \$
A	BL-G3-0006	15W	6500 K	1350	105x230x60	Beyaz/White	30,90 \$
A	BL-G3-0008	12W	4000 K	1080	100x200x60	Siyah/Black	28,80 \$
A	BL-G3-0009	12W	6500 K	1080	100x200x60	Siyah/Black	28,80 \$
A	BL-G3-0011	15W	4000 K	1350	105x230x60	Siyah/Black	30,90 \$
A	BL-G3-0012	15W	6500 K	1350	105x230x60	Siyah/Black	30,90 \$

SENSÖRLÜ LED GLOP
LED GLOBE WITH SENSOR

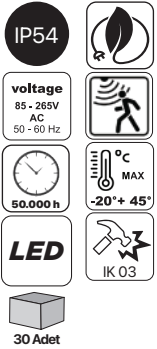

Enerji Verimliliği Sınıfı	Ürün Kodu	Güç (W)	Renk Sıcaklığı (K)	Işık Akısı (Lm)	Ürün Ölçüsü ØxH mm	Fiyat
A	BL-G4-0001-S	12W	3000 K	960	175 x 55	30,50 \$
A	BL-G4-0002-S	12W	4000 K	960	175 x 55	30,50 \$
A	BL-G4-0003-S	12W	6500 K	960	175 x 55	30,50 \$
A	BL-G4-0004-S	15W	3000 K	1200	175 x 55	31,30 \$
A	BL-G4-0005-S	15W	4000 K	1200	175 x 55	31,30 \$
A	BL-G4-0006-S	15W	6500 K	1200	175 x 55	31,30 \$

SENSÖRLÜ LED APLİK
LED WALL LUMINAIRE WITH SENSOR

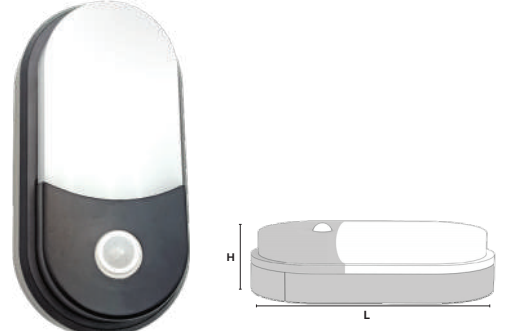
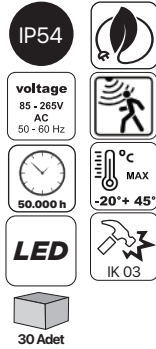

Enerji Verimliliği Sınıfı	Ürün Kodu	Güç (W)	Renk Sıcaklığı (K)	Işık Akısı (Lm)	Ürün Ölçüsü WxLxH mm	Fiyat
A	BL-A1-0001-S	12W	3000 K	960	100 x 200 x 55	27,20 \$
A	BL-A1-0002-S	12W	4000 K	960	100 x 200 x 55	27,20 \$
A	BL-A1-0003-S	12W	6500 K	960	100 x 200 x 55	27,20 \$
A	BL-A1-0004-S	15W	3000 K	1200	100 x 200 x 55	28,30 \$
A	BL-A1-0005-S	15W	4000 K	1200	100 x 200 x 55	28,30 \$
A	BL-A1-0006-S	15W	6500 K	1200	100 x 200 x 55	28,30 \$

RAY SPOT AYDINLATMALARI

Çok Yönlü ve Vurgulu Aydınlatma Çözümleri ile Mekanları Dönüştürün



KONUT TİPİ RAY SPOT HOUSING TYPE RAIL SPOT

IP20



YENİ ÜRÜN



IP20



YENİ ÜRÜN

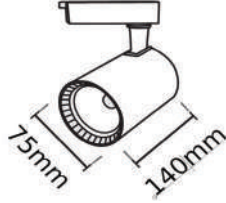

Enerji Verimliliği Sınıfı	Ürün Kodu	Güç (W)	Renk Sıcaklığı (K)	Işık Akısı (Lm)	Ürün Ölçüsü WxLxH mm	Fiyat
A B F	BL-KT-0001	10W	3000 K	1200	50 x 140	17,80 \$
A B F	BL-KT-0002		4000 K		50 x 140	17,80 \$
A B F	BL-KT-0003		6500 K		50 x 140	17,80 \$
A B F	BL-KT-0007	30W	3000 K	3600	75 x 180	21,60 \$
A B F	BL-KT-0008		4000 K		75 x 180	21,60 \$
A B F	BL-KT-0009		6500 K		75 x 180	21,60 \$

Enerji Verimliliği Sınıfı	Ürün Kodu	Güç (W)	Renk Sıcaklığı (K)	Işık Akısı (Lm)	Ürün Ölçüsü WxLxH mm	Fiyat
A B F	BL-KT-0004	10W	3000 K	1200	50 x 140	17,80 \$
A B F	BL-KT-0005		4000 K		50 x 140	17,80 \$
A B F	BL-KT-0006		6500 K		50 x 140	17,80 \$
A B F	BL-KT-0010	30W	3000 K	3600	75 x 180	21,60 \$
A B F	BL-KT-0011		4000 K		75 x 180	21,60 \$
A B F	BL-KT-0012		6500 K		75 x 180	21,60 \$

YUVARLAK LED RAY SPOT ROUND LED RAIL SPOT LIGHTS

IP20



YENİ ÜRÜN



IP20



YENİ ÜRÜN

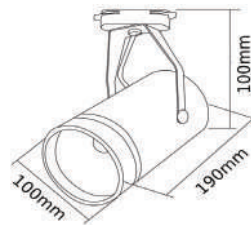

Enerji Verimliliği Sınıfı	Ürün Kodu	Güç (W)	Renk Sıcaklığı (K)	Işık Akısı (Lm)	Ürün Ölçüsü WxLxH mm	Fiyat
A B F	BL-RS-0007	30W	3000 K	2700	100x190x100	37,40 \$
A B F	BL-RS-0008		4000 K		100x190x100	37,40 \$
A B F	BL-RS-0009		6500 K		100x190x100	37,40 \$

Enerji Verimliliği Sınıfı	Ürün Kodu	Güç (W)	Renk Sıcaklığı (K)	Işık Akısı (Lm)	Ürün Ölçüsü WxLxH mm	Fiyat
A B F	BL-RS-0004	30W	3000 K	2700	100x190x100	37,40 \$
A B F	BL-RS-0005		4000 K		100x190x100	37,40 \$
A B F	BL-RS-0006		6500 K		100x190x100	37,40 \$

Sensörlü Koridor Merdiven Armatürü





IP40

LED



100 Adet

YENİ
ÜRÜN



Enerji Verimliliği Sınıfı	Ürün Kodu	Güç (W)	Renk Sıcaklığı (K)	Işık Akısı (Lm)	Ürün Ölçüsü WxLxH mm	Renk	Fiyat
A	BL-SD-0001	1W	3000 K	70	85 x 85 x 25	Beyaz/White	10,00 \$
B	BL-SD-0002		4000 K		85 x 85 x 25	Beyaz/White	10,00 \$
C	BL-SD-0003		6500 K		85 x 85 x 25	Beyaz/White	10,00 \$
D	BL-SD-0004		3000 K		85 x 85 x 25	Siyah/Black	10,00 \$
E	BL-SD-0005		4000 K		85 x 85 x 25	Siyah/Black	10,00 \$
F	BL-SD-0006		6500 K		85 x 85 x 25	Siyah/Black	10,00 \$
G	BL-SD-0007		3000 K		85 x 85 x 25	Gri/Gray	10,00 \$
H	BL-SD-0008		4000 K		85 x 85 x 25	Gri/Gray	10,00 \$
I	BL-SD-0009		6500 K		85 x 85 x 25	Gri/Gray	10,00 \$



Acil Çıkış Yönlendirme Armatürleri

Güvenli tahliye için dayanıklı ve yüksek görünürlüklü
LED çözümler





IP40



LED

voltage
220 - 240V
AC
50 - 60 Hz



°C
MAX
-20°+ 45°

20 Adet

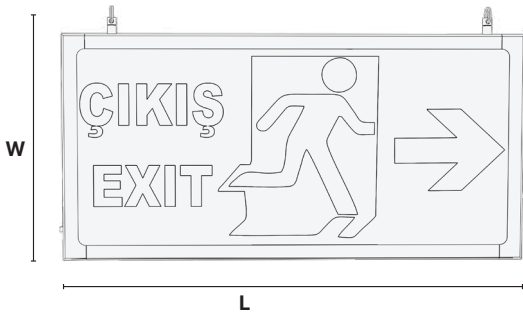

Ürün Kodu	Ürün Görseli	Açıklama	Güç (W)	Acilde Kullanım	Işık Akısı (Lm)	Ürün Ölçüsü WxLxH mm	Fiyat
BL-AC-0006		ACİL ÇIKIŞ ARMATÜRÜ 3H ACİL KİTLİ (SAĞ-SOL YÖN) (KAPI YEŞİL VE İNSAN BEYAZ RENKLİ)	3W	3 Saat	120	155x325x22	12,70 \$
BL-AC-0008		ACİL ÇIKIŞ ARMATÜRÜ 3H ACİL KİTLİ (AŞAĞI YÖN) (KAPI YEŞİL VE İNSAN BEYAZ RENKLİ)				155x325x22	12,70 \$
BL-AC-0010		ACİL ÇIKIŞ ARMATÜRÜ 3H ACİL KİTLİ (YÖNSÜZ KAPISIZ VE İNSANSIZ)				155x325x22	12,70 \$
BL-AC-0011		ACİL ÇIKIŞ ARMATÜRÜ 3H ACİL KİTLİ (YUKARI YÖN) (KAPI YEŞİL VE İNSAN BEYAZ RENKLİ)				155x325x22	12,70 \$



Sıva Altı Spot Kasalar

Profesyonel Sıva Altı Aydınlatma Çözümleri



YUVARLAK SPOT KASA SİYAH
ROUND BLACK SPOT HOUSING

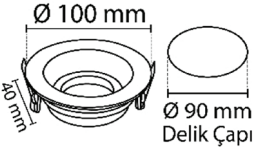

Ürün Kodu	Renk	Duy	Fiyat
BL-KS-0001	Siyah/Black	Gu10	3,00 \$

YUVARLAK SPOT KASA BEYAZ
ROUND WHITE SPOT HOUSING

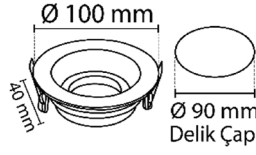
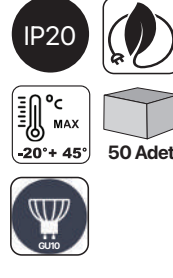

Ürün Kodu	Renk	Duy	Fiyat
BL-KS-0002	Beyaz/White	Gu10	3,00 \$

KARE SPOT KASA SİYAH
SQUARE BLACK SPOT HOUSING

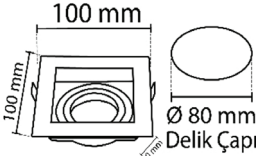
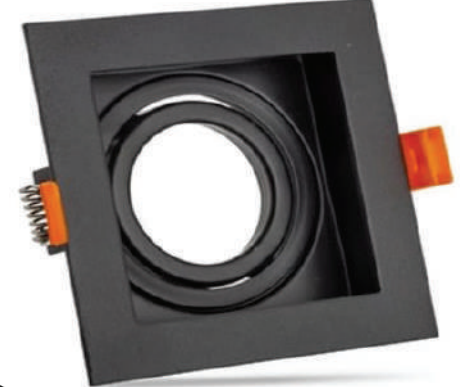

Ürün Kodu	Renk	Duy	Fiyat
BL-KS-0003	Siyah/Black	Gu10	3,10 \$

KARE SPOT KASA BEYAZ
SQUARE WHITE SPOT HOUSING

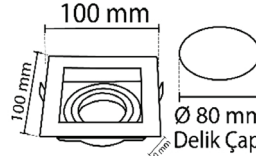
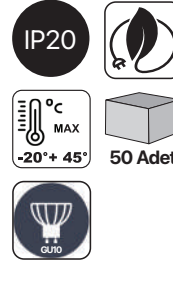

Ürün Kodu	Renk	Duy	Fiyat
BL-KS-0004	Beyaz/White	Gu10	3,10 \$

KARE SPOT KASA 2'Lİ SİYAH
SQUARE BLACK DOUBLE CASE SPOT HOUSING

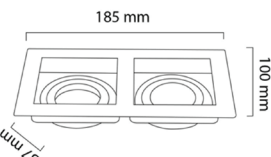

Ürün Kodu	Renk	Duy	Fiyat
BL-KS-0005	Siyah/Black	Gu10	4,70 \$

KARE SPOT KASA 2'Lİ BEYAZ
SQUARE WHITE DOUBLE CASE SPOT HOUSING

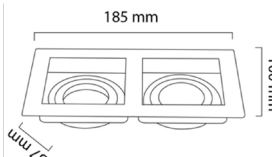
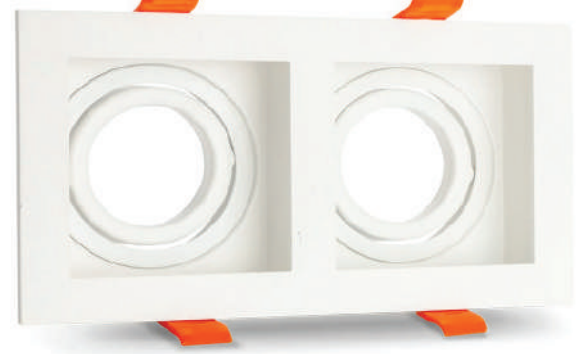
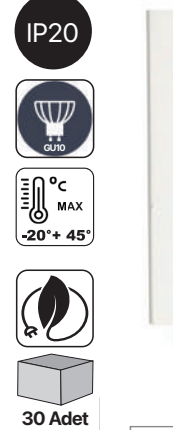

Ürün Kodu	Renk	Duy	Fiyat
BL-KS-0006	Beyaz/White	Gu10	4,70 \$

Sıva Altı Spot Kasalar

Modern ve Şık LED Aydınlatma Çözümleri



SIVA ALTI SPOT KASA
FLUSH MOUNTED SPOT CASE



DEKORATİF YUVARLAK SPOT KASA SİYAH
ROUND BLACK DECORATIVE SPOT HOUSING

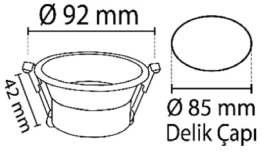
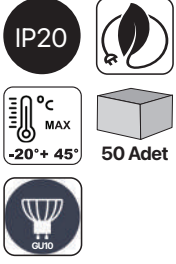

Ürün Kodu	Renk	Duy	Fiyat
BL-DKS-0001	Siyah/Black	Gu10	2,30 \$

DEKORATİF YUVARLAK SPOT KASA BEYAZ
ROUND WHITE DECORATIVE SPOT HOUSING

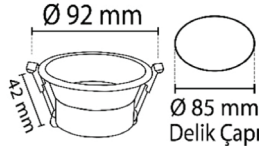

Ürün Kodu	Renk	Duy	Fiyat
BL-DKS-0002	Beyaz/White	Gu10	2,30 \$

DEKORATİF KARE SPOT KASA SİYAH
SQUARE BLACK DECORATIVE SPOT HOUSING

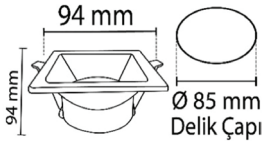
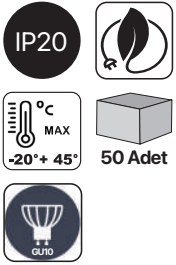

Ürün Kodu	Renk	Duy	Fiyat
BL-DKS-0003	Siyah/Black	Gu10	2,40 \$

DEKORATİF KARE SPOT KASA BEYAZ
SQUARE WHITE DECORATIVE SPOT HOUSING

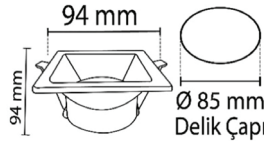

Ürün Kodu	Renk	Duy	Fiyat
BL-DKS-0004	Beyaz/White	Gu10	2,40 \$

DEKORATİF KARE SPOT KASA 2'Lİ SİYAH
SQUARE BLACK DECORATIVE DOUBLE CASE SPOT HOUSING

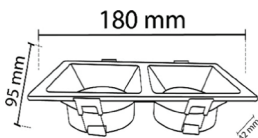

Ürün Kodu	Renk	Duy	Fiyat
BL-DKS-0005	Siyah/Black	Gu10	4,00 \$

DEKORATİF KARE SPOT KASA 2'Lİ BEYAZ
SQUARE WHITE DECORATIVE DOUBLE CASE SPOT HOUSING

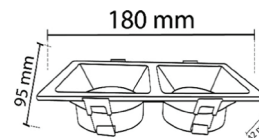
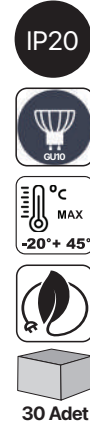

Ürün Kodu	Renk	Duy	Fiyat
BL-DKS-0006	Beyaz/White	Gu10	4,00 \$

Slim LED Trafo

Yüksek verimlilik, ince tasarım ve güvenilirlik.

Dar alanlar için ideal çözüm. Farklı güç seçenekleri ve gelişmiş koruma özellikleri ile aydınlatma projeniz için mükemmel enerji kaynağı.



SLIM LED TRAF0SU (ECO) 60W
SLIM LED TRANSFORMER



Ürün Kodu	Güç (W)	Giriş Voltajı	Gerilim	Çıkış Akımı	Boyutlar (WxLxH) mm	Fiyat
BL-ETRF-0001	60	AC 180-265V	12V	5A	35x120x23	5,70 \$

SLIM LED TRAF0SU (ECO) 200W
SLIM LED TRANSFORMER



Ürün Kodu	Güç (W)	Giriş Voltajı	Gerilim	Çıkış Akımı	Boyutlar (WxLxH) mm	Fiyat
BL-ETRF-0004	200	AC 180-265V	12V	16,5A	50x180x25	11,50 \$

SLIM LED TRAF0SU (ECO) 120W
SLIM LED TRANSFORMER



Ürün Kodu	Güç (W)	Giriş Voltajı	Gerilim	Çıkış Akımı	Boyutlar (WxLxH) mm	Fiyat
BL-ETRF-0002	120	AC 180-265V	12V	10A	35x135x25	8,20 \$

SLIM LED TRAF0SU (ECO) 300W
SLIM LED TRANSFORMER



Ürün Kodu	Güç (W)	Giriş Voltajı	Gerilim	Çıkış Akımı	Boyutlar (WxLxH) mm	Fiyat
BL-ETRF-0005	300	AC 180-265V	12V	25A	50x210x25	14,70 \$

SLIM LED TRAF0SU (ECO) 150W
SLIM LED TRANSFORMER



Ürün Kodu	Güç (W)	Giriş Voltajı	Gerilim	Çıkış Akımı	Boyutlar (WxLxH) mm	Fiyat
BL-ETRF-0003	150	AC 180-265V	12V	12,5A	50x140x25	9,30 \$

SLIM LED TRAF0SU (ECO) 400W
SLIM LED TRANSFORMER



Ürün Kodu	Güç (W)	Giriş Voltajı	Gerilim	Çıkış Akımı	Boyutlar (WxLxH) mm	Fiyat
BL-ETRF-0006	400	AC 180-265V	12V	33A	50x240x25	16,60 \$

SLIM LED TRAFOSU 60W
SLIM LED TRANSFORMER

IP20

YENİ
ÜRÜN



50 Adet



IP20

YENİ
ÜRÜN



30 Adet



Ürün Kodu	Güç (W)	Giriş Voltajı	Gerilim	Çıkış Akımı	Boyutlar (WxLxH) mm	Fiyat
BL-STRF-0001	60	AC 180-265V	12V	5A	35x120x23	8,50 \$

Ürün Kodu	Güç (W)	Giriş Voltajı	Gerilim	Çıkış Akımı	Boyutlar (WxLxH) mm	Fiyat
BL-STRF-0004	200	AC 180-265V	12V	16,5A	50x180x25	14,80 \$

SLIM LED TRAFOSU 120W
SLIM LED TRANSFORMER

IP20

YENİ
ÜRÜN



50 Adet



IP20

YENİ
ÜRÜN



30 Adet



Ürün Kodu	Güç (W)	Giriş Voltajı	Gerilim	Çıkış Akımı	Boyutlar (WxLxH) mm	Fiyat
BL-STRF-0002	120	AC 180-265V	12V	10A	35x135x25	10,70 \$

Ürün Kodu	Güç (W)	Giriş Voltajı	Gerilim	Çıkış Akımı	Boyutlar (WxLxH) mm	Fiyat
BL-STRF-0005	250	AC 180-265V	12V	25A	50x210x25	16,70 \$

SLIM LED TRAFOSU 150W
SLIM LED TRANSFORMER

IP20

YENİ
ÜRÜN



40 Adet



IP20

YENİ
ÜRÜN



30 Adet



Ürün Kodu	Güç (W)	Giriş Voltajı	Gerilim	Çıkış Akımı	Boyutlar (WxLxH) mm	Fiyat
BL-STRF-0003	150	AC 180-265V	12V	12,5A	50x140x25	13,90 \$

Ürün Kodu	Güç (W)	Giriş Voltajı	Gerilim	Çıkış Akımı	Boyutlar (WxLxH) mm	Fiyat
BL-STRF-0006	360	AC 180-265V	12V	33A	50x240x25	20,50 \$

Acil Aydınlatma Kitleri

Güvenlik ve Verimlilik için Gelişmiş
Acil Aydınlatma Kit Grubu



SLİM ACİL AYDINLATMA KİTİ SLIM EMERGENCY LIGHTING KIT

IP40



°C MAX
-20° + 45°

50 Adet

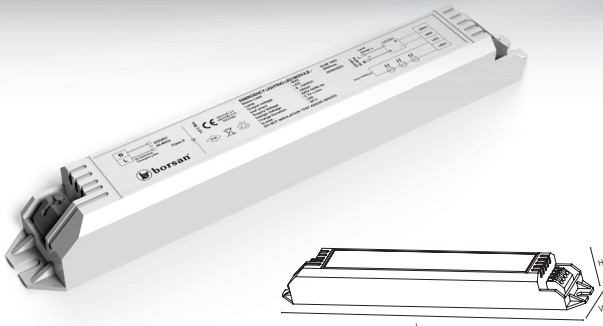

Ürün Kodu	Güç (W)	Çıkış Akımı (Max)	Pil Kapasitesi	Çalışma Süresi (Max)	Bağlantı Tipi	Boyutlar (WxLxH) mm	Fiyat
132-1453	50W	<30mA	2600mA	3 saat	Klemens Terminal	31 X 210 X 25	30,00 \$

KOMPAKT ACİL AYDINLATMA KİTİ COMPACT EMERGENCY LIGHTING KIT

IP40



°C MAX
-20° + 45°

50 Adet

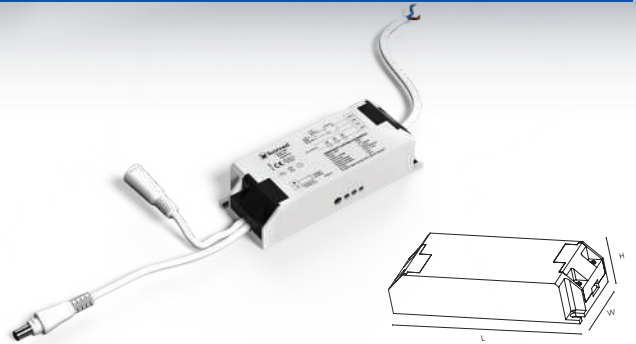

Ürün Kodu	Güç (W)	Çıkış Akımı (Max)	Pil Kapasitesi	Çalışma Süresi (Max)	Bağlantı Tipi	Boyutlar (WxLxH) mm	Fiyat
132-1454	50W	<30mA	2200mA	3 saat	Dişi/Erkek Konnektör	42 X 110 X 25	17,70 \$



Dedektör ve Sensörler

Akıllı ve Güvenilir Hareket Algılama Çözümleri
LED çözümler

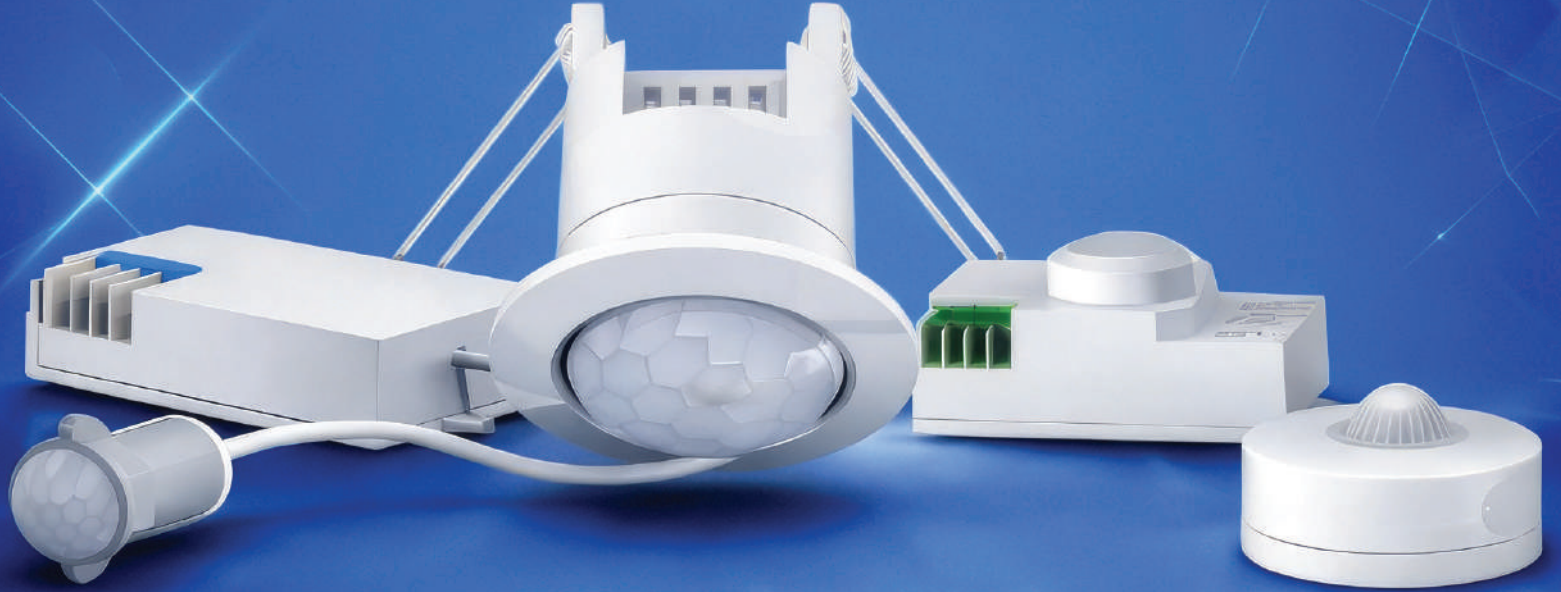

Sensör Modülleri

Gelişmiş Hareket ve Işık Kontrolü



MİNİ SENSÖR MINI SENSOR



200 Adet

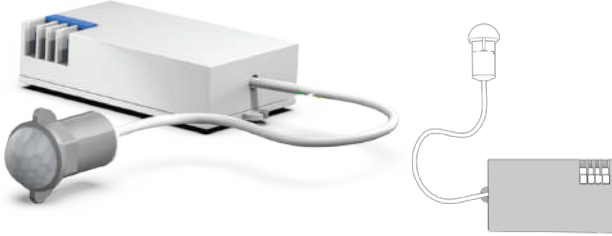

Ürün Kodu	Güç (W)	Akım	Montaj Yüksekliği	Çalışma Sıcaklığı	Algılama Mesafesi	Giriş Voltajı	Frekans	Fiyat
BR-MS001	1200W	Max 10A	2.2 - 4m	-10°C / +40°C	Max 8m	220-240V AC	50-60Hz	12,60 \$

SIVA ALTI 360° SENSÖR FLUSH MOUNTED 360° SENSOR



100 Adet



Ürün Kodu	Güç (W)	Anma Yüğü	Montaj Yüksekliği	Çalışma Sıcaklığı	Algılama Mesafesi	Giriş Voltajı	Frekans	Fiyat
BR-SA360	1200W	Max 1200W Tungsten Max 300W Floresan	2.5 - 3.5 m	-20°C / +40°C	Max 6m	220-240V AC	50Hz	12,60 \$

RADAR SENSÖR RADAR SENSOR



200 Adet



Ürün Kodu	Güç (W)	Akım	Koruma Sınıfı	Çalışma Sıcaklığı	Algılama Mesafesi	Giriş Voltajı	Frekans	Fiyat
BR-RS001	1200W	Max 10A	IP20	-10°C / +40°C	2 - 8 m	220-240V AC	50-60Hz	15,70 \$

SIVA ÜSTÜ 360° SENSÖR SURFACE MOUNTED 360° SENSOR



100 Adet



Ürün Kodu	Güç (W)	Anma Yüğü	Montaj Yüksekliği	Çalışma Sıcaklığı	Algılama Mesafesi	Giriş Voltajı	Frekans	Fiyat
BR-SU360	1200W	Max 1200W Tungsten Max 300W Floresan	2.2 - 4 m	-20°C / +40°C	Max 8m	220-240V AC	50Hz	12,60 \$

LED Tavan Armatür ve Aplik Grubu

Modern Tasarım, Yüksek Verimlilik, Estetik Aydınlatma Çözümleri



KARE LED TAVAN GLOP ARMATÜR
KARE LED CEILING GLOBE ARMATURE

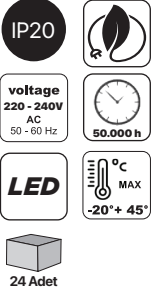

Enerji Verimliliği Sınıfı	Ürün Kodu	Güç (W)	Renk Sıcaklığı (K)	Işık Akısı (Lm)	Ürün Ölçüsü WxLxH mm	Kutu Adedi	Fiyat
A G	BL-B1-0007	12W	6500 K	960	250 x 250 x 93	2	21,90 \$
A G	BL-B1-0008		3000 K		250 x 250 x 93	2	21,90 \$

UFO LED TAVAN GLOP ARMATÜR
UFO LED CEILING GLOBE ARMATURE

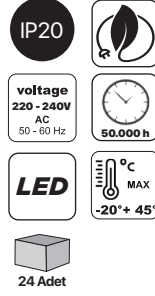

Enerji Verimliliği Sınıfı	Ürün Kodu	Güç (W)	Renk Sıcaklığı (K)	Işık Akısı (Lm)	Ürün Ölçüsü ØxH mm	Kutu Adedi	Fiyat
A G	BL-B1-0009	11W	6500 K	880	222 x 99	2	19,20 \$
A G	BL-B1-0010		3000 K		222 x 99	2	19,20 \$

İNCİ LED TAVAN GLOP ARMATÜR
İNCİ LED CEILING GLOBE ARMATURE

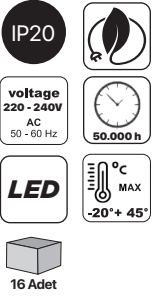

Enerji Verimliliği Sınıfı	Ürün Kodu	Güç (W)	Renk Sıcaklığı (K)	Işık Akısı (Lm)	Ürün Ölçüsü ØxH mm	Kutu Adedi	Fiyat
A G	BL-B1-0011	11W	6500 K	880	290 x 90	2	28,50 \$
A G	BL-B1-0012		3000 K		290 x 90	2	28,50 \$

OKYANUS LED TAVAN GLOP ARMATÜR
OKYANUS LED CEILING GLOBE ARMATURE

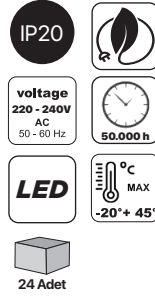

Enerji Verimliliği Sınıfı	Ürün Kodu	Güç (W)	Renk Sıcaklığı (K)	Işık Akısı (Lm)	Ürün Ölçüsü ØxH mm	Kutu Adedi	Fiyat
A G	BL-B1-0015	24W	6500 K	1560	345 x 50	2	27,60 \$
A G	BL-B1-0016		3000 K		345 x 50	2	27,60 \$

İSTANBUL LED TAVAN GLOP ARMATÜR
İSTANBUL LED CEILING GLOBE ARMATURE

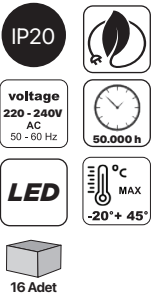

Enerji Verimliliği Sınıfı	Ürün Kodu	Güç (W)	Renk Sıcaklığı (K)	Işık Akısı (Lm)	Ürün Ölçüsü ØxH mm	Kutu Adedi	Fiyat
A G	BL-B1-0017	24W	6500 K	880	290 x 90	2	28,20 \$
A G	BL-B1-0018		3000 K		290 x 90	2	28,20 \$

ASOS LED TAVAN GLOP ARMATÜR
ASOS LED CEILING GLOBE ARMATURE

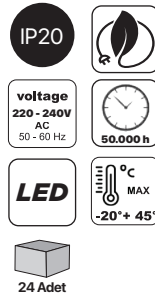

Enerji Verimliliği Sınıfı	Ürün Kodu	Güç (W)	Renk Sıcaklığı (K)	Işık Akısı (Lm)	Ürün Ölçüsü ØxH mm	Kutu Adedi	Fiyat
A G	BL-B1-0019	12W	6500 K	1560	345 x 50	2	25,80 \$
A G	BL-B1-0020		3000 K		345 x 50	2	25,80 \$



EKOTA LED DUVAR APLİK
EKOTA LED WALL LIGHTING FIXTURE

EKOLIGHT LED DUVAR APLİK
EKOLIGHT LED WALL LIGHTING FIXTURE

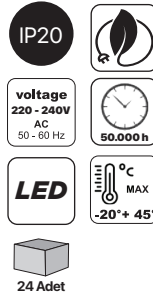
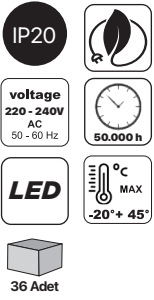

Enerji Verimliliği Sınıfı	Ürün Kodu	Güç (W)	Renk Sıcaklığı (K)	Işık Akısı (Lm)	Ürün Ölçüsü WxLxH mm	Kutu Adedi	Fiyat
A G	BL-B1-0001	12W	6500 K	960	150 x 260 x 50	2	16,60 \$
A G	BL-B1-0002		3000 K		150 x 260 x 50		

Enerji Verimliliği Sınıfı	Ürün Kodu	Güç (W)	Renk Sıcaklığı (K)	Işık Akısı (Lm)	Ürün Ölçüsü WxLxH mm	Kutu Adedi	Fiyat
A G	BL-B1-0003	12W	6500 K	960	168 x 276 x 50	2	16,90 \$
A G	BL-B1-0004		3000 K		168 x 276 x 50		

NEMLİYER LED DUVAR APLİK IP65
NEMLİYER LED WALL LIGHTING FIXTURE IP65

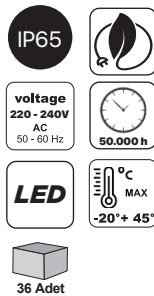

Enerji Verimliliği Sınıfı	Ürün Kodu	Güç (W)	Renk Sıcaklığı (K)	Işık Akısı (Lm)	Ürün Ölçüsü WxLxH mm	Kutu Adedi	Fiyat
A G	BL-B1-0005	12W	6500 K	750	135 x 235 x 55	2	17,70 \$
A G	BL-B1-0006		3000 K		135 x 235 x 55		



Tavan Armatür ve Aplikleri

Modern Aydınlatma Çözümleri



UFO TAVAN ARMATÜR (1XE27 DUY)
UFO CEILING ARMATURE

UFOLINE TAVAN ARMATÜR (1XE27 DUY)
UFOLINE CEILING ARMATURE

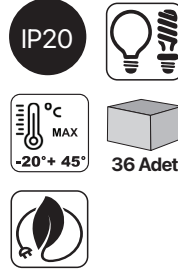
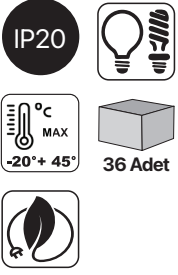

Ürün Kodu	Renk	Ürün Ölçüsü ØxH mm	Kutu Adedi	Fiyat
BR-00203-000	Beyaz/White	222 x 99	2	209,40 ₺



Ürün Kodu	Renk	Ürün Ölçüsü ØxH mm	Kutu Adedi	Fiyat
BR-00248-000	Beyaz/White	212x 98	2	195,00 ₺



UFOLUX TAVAN ARMATÜR (1XE27 DUY)
UFOLUX CEILING ARMATURE

GÜNEŞ TAVAN ARMATÜR (1XE27 DUY)
GÜNEŞ CEILING ARMATURE

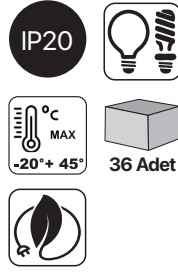
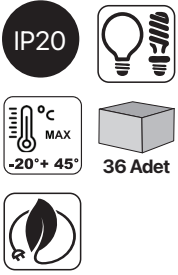

Ürün Kodu	Renk	Ürün Ölçüsü ØxH mm	Kutu Adedi	Fiyat
BR-00203-010	Beyaz/White	222 x 99	2	214,90 ₺



Ürün Kodu	Renk	Ürün Ölçüsü ØxH mm	Kutu Adedi	Fiyat
BR-00203-020	Beyaz/White	222 x 99	2	213,40 ₺



VEGA TAVAN ARMATÜR (1XE27 DUY)
VEGA CEILING ARMATURE

İSIS TAVAN ARMATÜR (1XE27 DUY)
İSIS CEILING ARMATURE

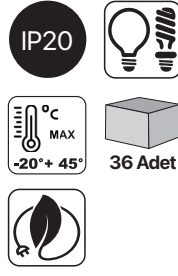
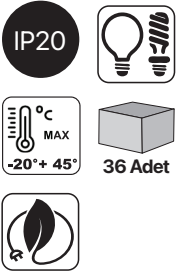

Ürün Kodu	Renk	Ürün Ölçüsü ØxH mm	Kutu Adedi	Fiyat
BR-00248-010	Beyaz/White	212 x 98	2	194,50 ₺



Ürün Kodu	Renk	Ürün Ölçüsü WxLxH mm	Kutu Adedi	Fiyat
BR-00244-000	Beyaz/White	214 x 314 x 88	2	291,40 ₺



KRAL DEKORATİF DUVAR APLİK ARMATÜR (1XE27 DUY)
KRAL DECORATIVE WALL LUMINAIRE

KRAL KAFESLİ DUVAR APLİK ARMATÜR (1XE27 DUY)
KRAL CAGED WALL LUMINAIRE

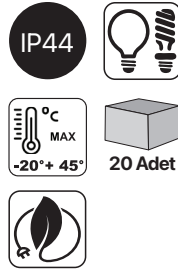
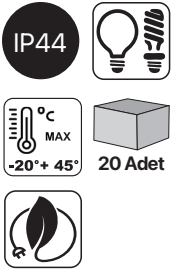

Ürün Kodu	Renk	Ürün Ölçüsü WxLxH mm	Kutu Adedi	Fiyat
BR-00220-000	Beyaz/White	260 x 165 x 102	1	421,10 ₺



Ürün Kodu	Renk	Ürün Ölçüsü WxLxH mm	Kutu Adedi	Fiyat
BR-00220-001	Beyaz/White	260 x 165 x 110	2	438,10 ₺



ASOS TAVAN ARMATÜR (1XE27 DUY)
ASOS CEILING ARMATURE

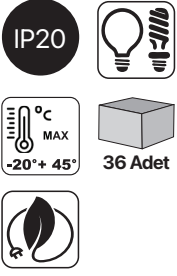

Ürün Kodu	Renk	Ürün Ölçüsü WxLxH mm	Kutu Adedi	Fiyat
BR-00244-010	Beyaz/White	214 x 314 x 88	2	295,80 ₺



KARE TAVAN ARMATÜR (1XE27 DUY)
KARE CEILING ARMATURE

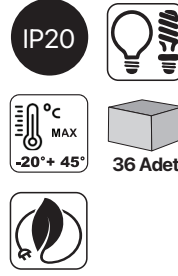

Ürün Kodu	Renk	Ürün Ölçüsü WxLxH mm	Kutu Adedi	Fiyat
BR-00242-000	Beyaz/White	250 x 250 x 93	2	304,30 ₺



KARE SOFT TAVAN ARMATÜR (1XE27 DUY)
KARE SOFT CEILING ARMATURE

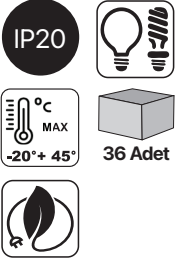

Ürün Kodu	Renk	Ürün Ölçüsü WxLxH mm	Kutu Adedi	Fiyat
BR-00242-010	Beyaz/White	250 x 250 x 93	2	297,60 ₺



YASMIN TAVAN ARMATÜR (1XE27 DUY)
YASMIN CEILING ARMATURE

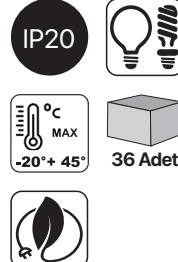

Ürün Kodu	Renk	Ürün Ölçüsü ØxH mm	Kutu Adedi	Fiyat
BR-00245-000	Beyaz/White	220 x 125	2	289,30 ₺



NEPTÜN TAVAN ARMATÜR (1XE27 DUY)
NEPTUN CEILING ARMATURE

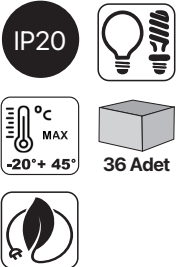

Ürün Kodu	Renk	Ürün Ölçüsü ØxH mm	Kutu Adedi	Fiyat
BR-00245-010	Beyaz/White	220 x 125	2	304,50 ₺



VENÜS TAVAN ARMATÜR (1XE27 DUY)
VENUS CEILING ARMATURE

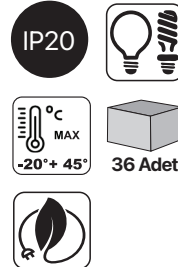

Ürün Kodu	Renk	Ürün Ölçüsü ØxH mm	Kutu Adedi	Fiyat
BR-00201-000	Beyaz/White	240 x 100	2	309,90 ₺



NEMLİYER DEKORATİF DUVAR APLİK ARMATÜR
NEMLİYER DECORATIVE WALL LUMINAIRE

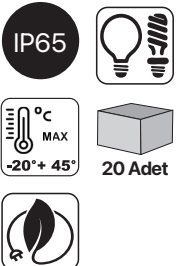

Ürün Kodu	Renk	Ürün Ölçüsü WxLxH mm	Kutu Adedi	Fiyat
BR-00222-000	Beyaz/White	260 x 165 x 102	1	321,20 ₺



NEMLİYER KAFESLİ DEKORATİF DUVAR APLİK ARMATÜR
NEMLİYER CAGED WALL LUMINAIRE

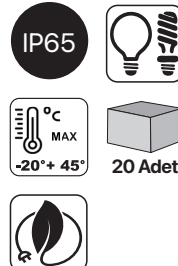

Ürün Kodu	Renk	Ürün Ölçüsü WxLxH mm	Kutu Adedi	Fiyat
BR-00222-001	Beyaz/White	235 x 135 x 120	1	341,30 ₺



UZAY TAVAN ARMATÜR (1XE27 DUY)
UZAY CEILING ARMATURE

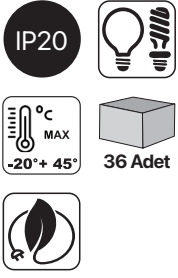

Ürün Kodu	Renk	Ürün Ölçüsü ØxH mm	Kutu Adedi	Fiyat
BR-00201-010	Beyaz/White	240 x 97	2	302,80 ₺



İSTANBUL TAVAN ARMATÜR (2XE27 DUY)
İSTANBUL CEILING ARMATURE

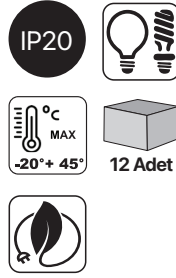

Ürün Kodu	Renk	Ürün Ölçüsü WxLxH mm	Kutu Adedi	Fiyat
BR-00247-000	Beyaz/White	315 x 275 x 90	2	384,90 ₺



BOSPHORUS TAVAN ARMATÜR (2XE27 DUY)
BOSPHORUS CEILING ARMATURE

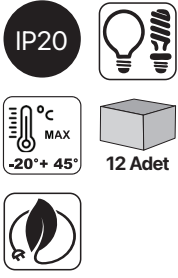

Ürün Kodu	Renk	Ürün Ölçüsü WxLxH mm	Kutu Adedi	Fiyat
BR-00247-010	Beyaz/White	315 x 275 x 90	2	380,70 ₺



GÖK SOFT TAVAN ARMATÜR (2XE27 DUY)
GOK SOFT CEILING ARMATURE



Ürün Kodu	Renk	Ürün Ölçüsü WxLxH mm	Kutu Adedi	Fiyat
BR-00230-010	Beyaz/White	355 x 355 x 97	2	713,20 ₺



GÖK SIVA ÜSTÜ TAVAN ARMATÜR (2XE27 DUY)
GOK SURFACE MOUNTED CEILING ARMATURE

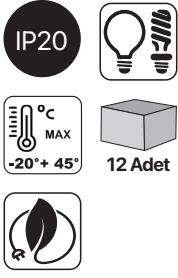

Ürün Kodu	Renk	Ürün Ölçüsü WxLxH mm	Kutu Adedi	Fiyat
BR-00230-000	Beyaz/White	355 x 355 x 97	2	721,50 ₺



TAÇ DUVAR APLİK ARMATÜR (1XE27 DUY)
TAC WALL LUMINAIRE

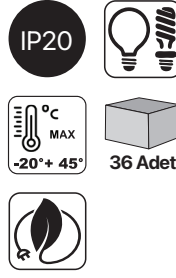

Ürün Kodu	Renk	Ürün Ölçüsü WxLxH mm	Kutu Adedi	Fiyat
BR-00249-000	Beyaz/White	240 x 120 x 120	2	133,30 ₺



PETEK DEKORATİF DUVAR APLİK ARMATÜR (1XE27 DUY)
PETEK DECORATIVE WALL LUMINAIRE

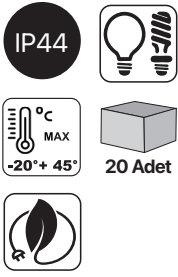

Ürün Kodu	Renk	Ürün Ölçüsü WxLxH mm	Kutu Adedi	Fiyat
BR-00220-010	Beyaz/White	260 x 165 x 102	1	417,10 ₺



PETEK KAFESLİ DUVAR APLİK ARMATÜR (1XE27 DUY)
PETEK CAGED WALL LUMINAIRE

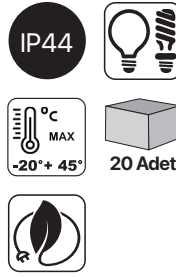

Ürün Kodu	Renk	Ürün Ölçüsü WxLxH mm	Kutu Adedi	Fiyat
BR-00220-011	Beyaz/White	260 x 165 x 110	2	436,00 ₺



OKYANUS SOFT TAVAN ARMATÜR (2XE27 DUY)
OKYANUS SOFT CEILING ARMATURE

OKYANUS TAVAN ARMATÜR (2XE27 DUY)
OKYANUS CEILING ARMATURE

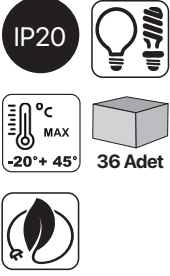

Ürün Kodu	Renk	Ürün Ölçüsü ØxH mm	Kutu Adedi	Fiyat
BR-00231-010	Beyaz/White	345 x 105	2	400,30 ₺

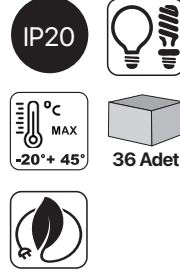

Ürün Kodu	Renk	Ürün Ölçüsü ØxH mm	Kutu Adedi	Fiyat
BR-00231-000	Beyaz/White	345 x 105	2	395,40 ₺



ATLANTİK TAVAN GLOP ARMATÜR (2XE27 DUY)
ATLANTİK CEILING ARMATURE

YAKUT TAVAN ARMATÜR (1XE27 DUY)
YAKUT CEILING ARMATURE

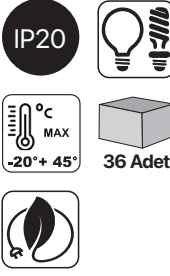

Ürün Kodu	Renk	Ürün Ölçüsü ØxH mm	Kutu Adedi	Fiyat
BR-00231-020	Beyaz/White	345 x 105	2	404,80 ₺

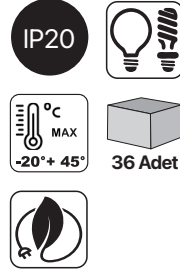

Ürün Kodu	Renk	Ürün Ölçüsü ØxH mm	Kutu Adedi	Fiyat
BR-00206-000	Beyaz/White	290 x 90	2	744,20 ₺



İNCİ TAVAN ARMATÜR (1XE27 DUY)
INCI CEILING ARMATURE

EKOTA DUVAR APLİK ARMATÜR (1XE27 DUY)
EKOTA WALL LUMINAIRE

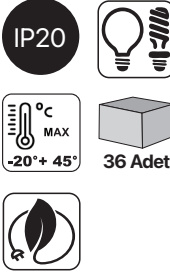

Ürün Kodu	Renk	Ürün Ölçüsü ØxH mm	Kutu Adedi	Fiyat
BR-00206-010	Beyaz/White	290 x 90	2	743,10 ₺

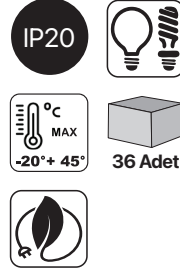

Ürün Kodu	Renk	Ürün Ölçüsü WxLxH mm	Kutu Adedi	Fiyat
BR-00307-000	Beyaz/White	276 x 168 x 100	2	227,80 ₺



EKOLIGHT DUVAR APLİK ARMATÜR (1XE27 DUY)
EKOLIGHT WALL LUMINAIRE

EKOSOFT DUVAR APLİK ARMATÜR (1XE27 DUY)
EKOSOFT WALL LUMINAIRE

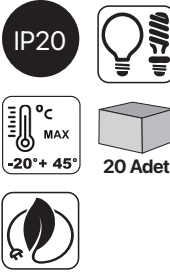

Ürün Kodu	Renk	Ürün Ölçüsü WxLxH mm	Kutu Adedi	Fiyat
BR-00246-000	Beyaz/White	276 x 168 x 100	1	256,20 ₺

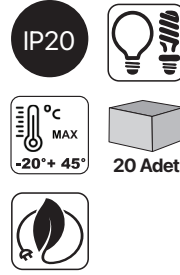

Ürün Kodu	Renk	Ürün Ölçüsü WxLxH mm	Kutu Adedi	Fiyat
BR-00246-010	Beyaz/White	276 x 168 x 100	2	242,30 ₺





ŞAH DUVAR APLİK ARMATÜR (1XE27 DUY)
SAH WALL LUMINAIRE

AYNA ÜSTÜ DUVAR APLİK ARMATÜR (2XE14 DUY)
AYNA USTU WALL LUMINAIRE

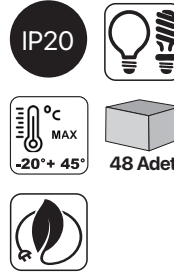
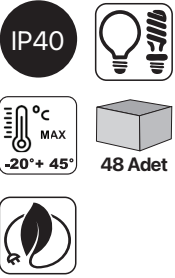

Ürün Kodu	Renk	Ürün Ölçüsü WxLxH mm	Kutu Adedi	Fiyat
BR-00309-000	Beyaz/White	150 x 87 x 230	2	230,40 ₺

Ürün Kodu	Renk	Ürün Ölçüsü WxLxH mm	Kutu Adedi	Fiyat
BR-00235-000	Beyaz/White	290 x 85 x 74	2	235,80 ₺

KRALIÇE DUVAR APLİK ARMATÜR (1XE27 DUY)
KRALICE WALL LUMINAIRE

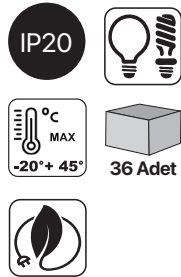

Ürün Kodu	Renk	Ürün Ölçüsü WxLxH mm	Kutu Adedi	Fiyat
BR-00306-000	Beyaz/White	166 x 236 x 114	1	222,40 ₺

Aksesuarlar

Kaliteli Aydınlatma Bileşenleri ve Elektrik Malzemeleri



ASKI TAKIMI PORSELEN
HANGER SET PORCELAIN

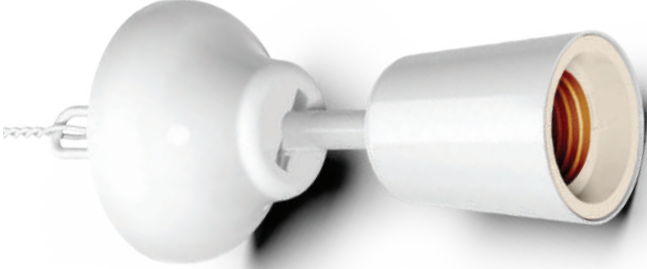

Ürün Kodu	Ürün Adı	Koli Adedi	Fiyat
BR-001411	Askı Takımı (E27 Seramik Duy)	100	52,00 ₺

GU10 DUY
GU10



E27 PORSELEN DUY
E27 PORCELAIN



Ürün Kodu	Ürün Adı	Koli Adedi	Fiyat
BR-GU-0001	Gu10 Duy	100	0,50 \$

Ürün Kodu	Ürün Adı	Koli Adedi	Fiyat
132-1535	E27 Porselen Duy	400	0,40 \$

TOPRAKLI DIŞI FİŞ ve L FİŞ
EARTHED FEMALE PLUG and L TYPE PLUG



MONOFAZE ERKEK FİŞ ve TOPRAKLI ERKEK FİŞ
MONOPHASE MALE PLUG and EARTHED MALE PLUG



Ürün Kodu	Ürün Adı	Kutu Adedi	Koli Adedi	Fiyat Fiyat
BR-1515	Topraklı Dişi Fiş Earthed Female Plug	40	480	180,40 ₺
BR-1516	L Tipi Topraklı Erkek Fiş L Type Earthed Male Plug	50	600	140,80 ₺
BR-1511	Topraklı Erkek Fiş Earthed Male Plug	50	600	160,50 ₺

Ürün Kodu	Ürün Adı	Kutu Adedi	Koli Adedi	Fiyat Fiyat
BR-1510	Monofaze Erkek Fiş Single Phase Male Plug	50	900	126,50 ₺
BR-1517	Siyah Monofaze Erkek Fiş Black Male Plug	50	900	126,00 ₺

Sıva Altı ve Sıva Üstü Sigorta Kutuları

Enerjinizi Güvende Tutun



2'li Mühürlü Sigorta Kutusu
2 Module Distribution Box - Sealed

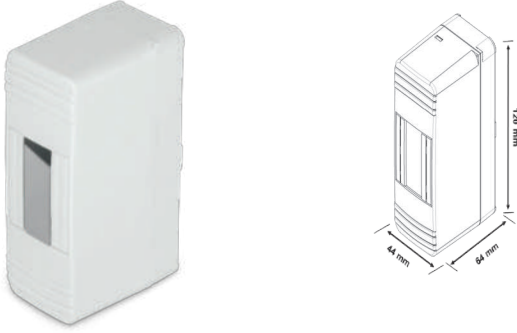

Ürün Kodu	Kutu Adedi	Koli Adedi	Fiyat
BR-818	1	98	54,20 ₺

4'lü Mühürlü Sigorta Kutusu
4 Module Distribution Box - Sealed



Ürün Kodu	Kutu Adedi	Koli Adedi	Fiyat
BR-819	1	98	92,90 ₺

2'li Sıva Üstü Sigorta Kutusu
2 Module Distribution Box - Surface Mounted

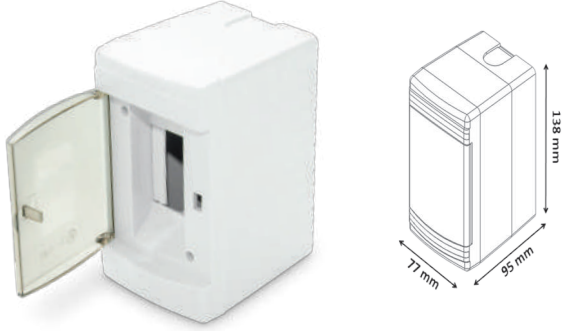

Ürün Kodu	Kutu Adedi	Koli Adedi	Fiyat
BR-820	2	40	183,40 ₺

2'li Sıva Altı Sigorta Kutusu
2 Module Distribution Box Recessed

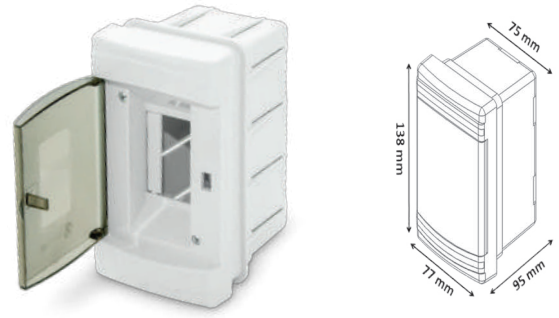

Ürün Kodu	Kutu Adedi	Koli Adedi	Fiyat
BR-821	2	40	164,40 ₺

6'lı Sıva Üstü Sigorta Kutusu
6 Module Distribution Box - Surface Mounted



Ürün Kodu	Kutu Adedi	Koli Adedi	Fiyat
BR-804	1	30	316,60 ₺

6'lı Sıva Altı Sigorta Kutusu
6 Module Distribution Box - Recessed



Ürün Kodu	Kutu Adedi	Koli Adedi	Fiyat
BR-803	1	30	273,00 ₺

9'lu Siva Üstü Sigorta Kutusu
9 Module Distribution Box - Surface Mounted



Ürün Kodu	Kutu Adedi	Koli Adedi	Fiyat
BR-806	1	20	402,40 ₺

9'lu Siva Altı Sigorta Kutusu
9 Module Distribution Box - Recessed

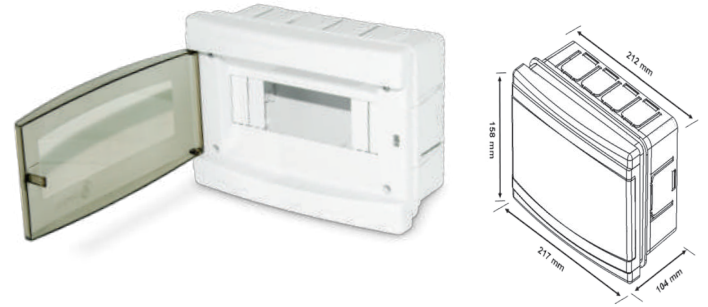

Ürün Kodu	Kutu Adedi	Koli Adedi	Fiyat
BR-805	1	20	344,20 ₺



12'li Siva Üstü Sigorta Kutusu
12 Module Distribution Box - Surface Mounted



Ürün Kodu	Kutu Adedi	Koli Adedi	Fiyat
BR-808	1	20	494,70 ₺

12'li Siva Altı Sigorta Kutusu
12 Module Distribution Box - Recessed



Ürün Kodu	Kutu Adedi	Koli Adedi	Fiyat
BR-807	1	20	430,60 ₺



16'lı Siva Üstü Sigorta Kutusu
16 Module Distribution Box - Surface Mounted



Ürün Kodu	Kutu Adedi	Koli Adedi	Fiyat
BR-816	1	10	660,60 ₺

16'lı Siva Altı Sigorta Kutusu
16 Module Distribution Box - Recessed



Ürün Kodu	Kutu Adedi	Koli Adedi	Fiyat
BR-815	1	10	607,70 ₺

18'li Sıva Üstü Sigorta Kutusu
18 Module Distribution Box - Surface Mounted



Ürün Kodu	Kutu Adedi	Koli Adedi	Fiyat
BR-814	2	10	574,70 ₺

18'li Sıva Altı Sigorta Kutusu
18 Module Distribution Box - Recessed



Ürün Kodu	Kutu Adedi	Koli Adedi	Fiyat
BR-813	2	10	547,90 ₺

24'lü Sıva Üstü Sigorta Kutusu
24 Module Distribution Box - Surface Mounted



Ürün Kodu	Kutu Adedi	Koli Adedi	Fiyat
BR-810	1	10	762,20 ₺

24'lü Sıva Altı Sigorta Kutusu
24 Module Distribution Box - Recessed



Ürün Kodu	Kutu Adedi	Koli Adedi	Fiyat
BR-809	1	10	676,30 ₺



36'lı Sıva Üstü Sigorta Kutusu
36 Module Distribution Box - Surface Mounted



Ürün Kodu	Kutu Adedi	Koli Adedi	Fiyat
BR-812	2	5	1.040,20 ₺

36'lı Sıva Altı Sigorta Kutusu
36 Module Distribution Box - Recessed

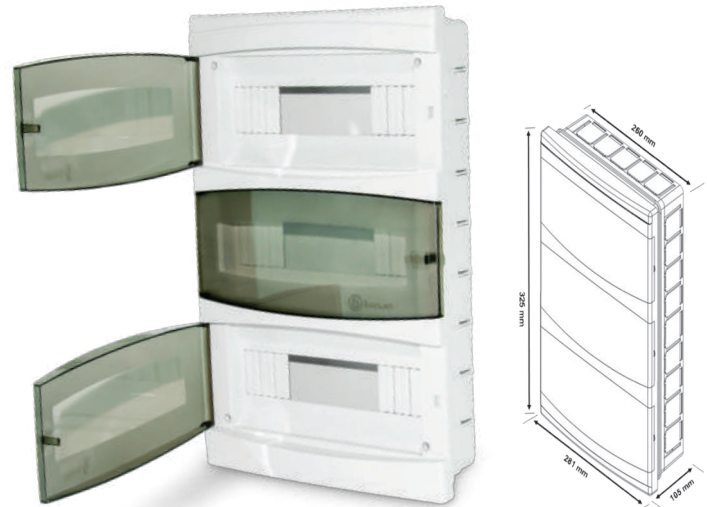

Ürün Kodu	Kutu Adedi	Koli Adedi	Fiyat
BR-811	2	5	952,20 ₺

Buat Grubu



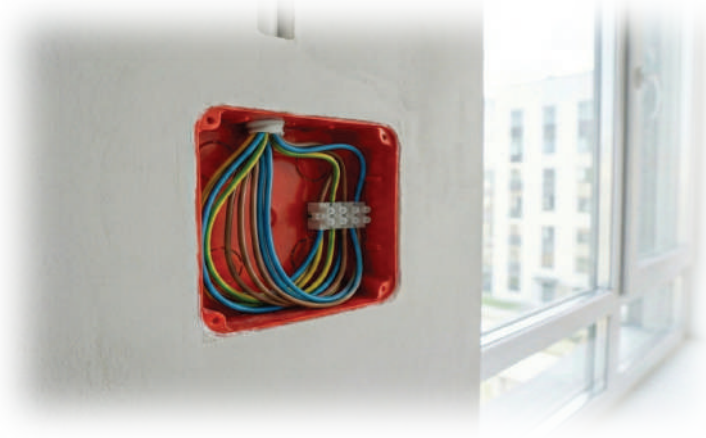

TERMOPLASTİK BUATLAR
THERMOPLASTIC JUNCTION BOXES



Ürün Kodu	Boyutlar (WxLxH) mm	Koli Adedi	Fiyat Fiyat
BR-750	70x80x40	50	84,50 ₺
BR-760	85x85x40	50	91,20 ₺
BR-770	110x110x55	20	130,60 ₺

LÜKS KARE BUATLAR
LUXURIOUS SQUARE JUNCTION BOXES



Ürün Kodu	Boyutlar (WxLxH) mm	Koli Adedi	Fiyat Fiyat
BR-730	80x80x40	140	34,30 ₺
BR-731	100x100x45	140	49,70 ₺
BR-732	130x130x55	180	72,40 ₺
BR-734	150x150x58	108	99,60 ₺
BR-733	200x200x70	60	187,70 ₺

BUATLAR
JUNCTION BOXES



Ürün Kodu	Boyutlar (WxLxH) mm	Koli Adedi	Fiyat Fiyat
BR-1713	Alçıpan Buat	100	39,70 ₺
BR-710	Lüks Buat Kapağı	100	10,20 ₺

GEÇMELİ ve ALÇIPAN KASA (KAPAKSIZ)
INTERLACED AND DRYWALL CASE (WITHOUT COVER)



Ürün Kodu	Boyutlar (WxLxH) mm	Renk	Koli Adedi	Fiyat Fiyat
BR-1413	Geçmeli Kasa Büyük	Turuncu	100	13,50 ₺
BR-1712	Alçıpan Kasa	Turuncu	200	25,00 ₺
BR-1413-E	Geçmeli Kasa Büyük	Siyah	100	12,80 ₺
BR-1712-E	Alçıpan Kasa	Siyah	200	24,30 ₺

Kablo Pabucu

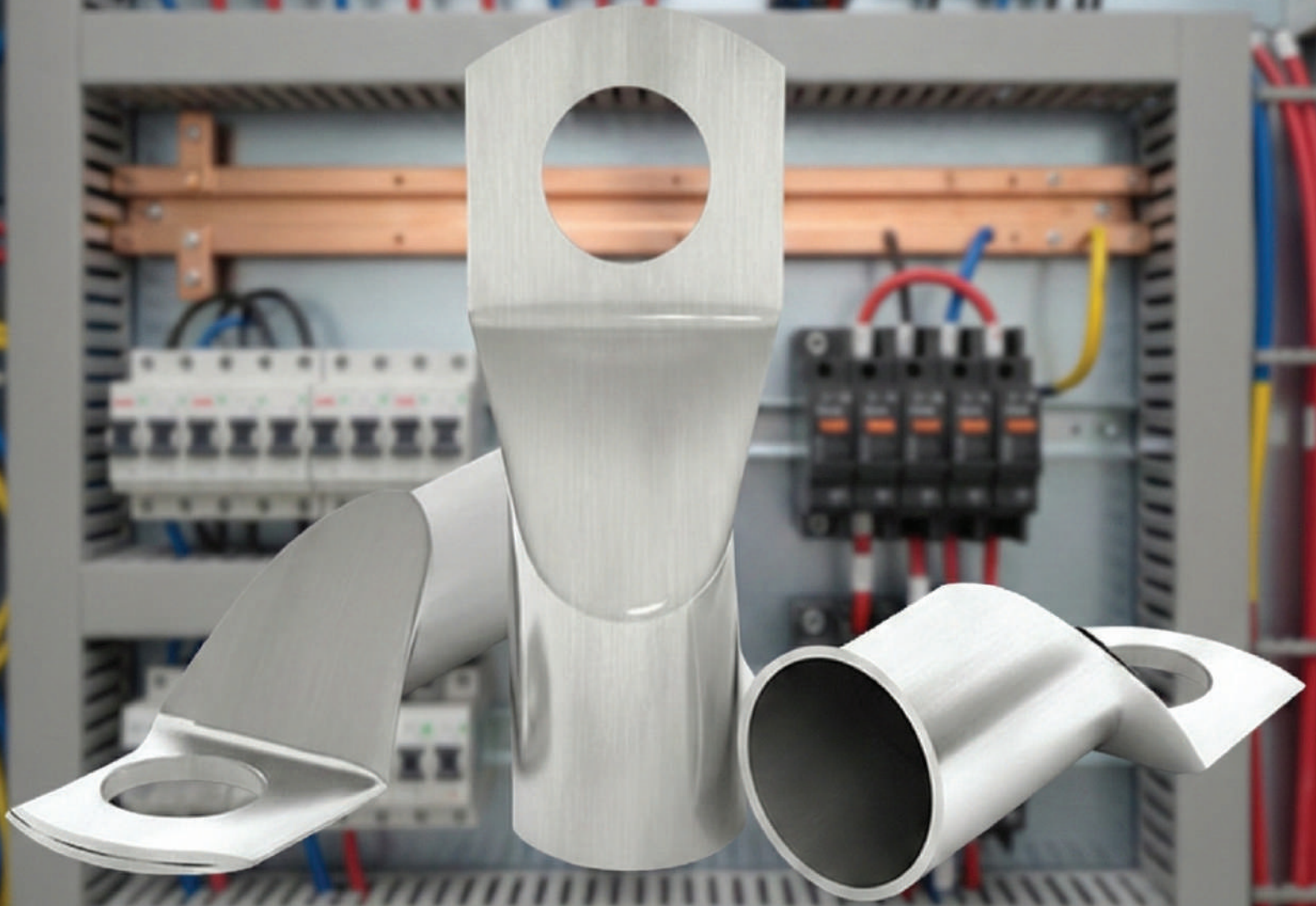



Ürün Kodu	Kesit	d1	Metrik (d2)	d4	Et Kalınlık	a	b	c1	c2	L	Kutu Adet	Fiyat
BR-1780 M5	6	4,5	5	5,8	0,65	13,4	8,4	5	6,5	24,9	1500	Fiyat Sorunuz
BR-1780-M5K	6	4,5	5	5,8	0,65	13,4	8,4	5	6,5	24,9	750	Fiyat Sorunuz
BR-1781 M5	10	4,9	5	6,2	0,65	13,9	10,3	6,6	7,3	27,8	1100	Fiyat Sorunuz
BR-1781-M5K	10	4,9	5	6,2	0,65	13,9	10,3	6,6	7,3	27,8	550	Fiyat Sorunuz
BR-1782 M6	16	6,6	6	7,9	0,65	17,15	11,7	6,4	7,6	31,15	650	Fiyat Sorunuz
BR-1782-M6K	16	6,6	6	7,9	0,65	17,15	11,7	6,4	7,6	31,15	325	Fiyat Sorunuz
BR-1782-M8	16	6,6	8	7,9	0,65	17,15	11,7	6,4	7,6	31,15	650	Fiyat Sorunuz
BR-1782-M8K	16	6,6	8	7,9	0,65	17,15	11,7	6,4	7,6	31,15	325	Fiyat Sorunuz
BR-1783 M8	25	7,5	8	9	0,75	22,5	13,25	8,2	7,9	38,6	420	Fiyat Sorunuz
BR-1783-M8K	25	7,5	8	9	0,75	22,5	13,25	8,2	7,9	38,6	210	Fiyat Sorunuz
BR-1784 M8	35	8,7	8	10,8	1,05	24,85	15,5	9,2	10,35	44,4	250	Fiyat Sorunuz
BR-1784-M8K	35	8,7	8	10,8	1,05	24,85	15,5	9,2	10,35	44,4	125	Fiyat Sorunuz
BR-1794 M10	35	8,7	10	10,8	1,05	24,85	15,5	9,2	10,35	44,4	250	Fiyat Sorunuz
BR-1794 M10K	35	8,7	10	10,8	1,05	24,85	15,5	9,2	10,35	44,4	125	Fiyat Sorunuz
BR-1785 M10	50	10,3	10	12,6	1,15	28,9	18,2	11,5	11,15	51,55	170	Fiyat Sorunuz
BR-1785-M10K	50	10,3	10	12,6	1,15	28,9	18,2	11,5	11,15	51,55	85	Fiyat Sorunuz
BR-1785 M12	50	10,3	12	12,6	1,15	28,9	18,2	11,5	11,15	51,55	170	Fiyat Sorunuz
BR-1786 M10	70	11,7	10	14,5	1,4	33,9	21	10,1	11,1	55,1	110	Fiyat Sorunuz
BR-1786 M12	70	11,7	12	14,5	1,4	33,9	21	10,1	11,1	55,1	110	Fiyat Sorunuz
BR-1787 M8	95	13,8	8	16,5	1,35	36,7	24,2	10,55	12,05	59,3	90	Fiyat Sorunuz
BR-1787 M10	95	13,8	10	16,5	1,35	36,7	24,2	10,55	12,05	59,3	90	Fiyat Sorunuz
BR-1787 M12	95	13,8	12	16,5	1,35	36,7	24,2	10,55	12,05	59,3	90	Fiyat Sorunuz
BR-1787 M14	95	13,8	14	16,5	1,35	36,7	24,2	10,55	12,05	59,3	90	Fiyat Sorunuz
BR-1788 M10	120	15,9	10	19,1	1,6	42,55	28,2	13,9	13,6	70,05	65	Fiyat Sorunuz
BR-1788 M12	120	15,9	12	19,1	1,6	42,55	28,2	13,9	13,6	70,05	65	Fiyat Sorunuz
BR-1788 M14	120	15,9	14	19,1	1,6	42,55	28,2	13,9	13,6	70,05	65	Fiyat Sorunuz
BR-1789 M10	150	17,3	10	20,6	1,65	42,2	29,95	16,7	16,8	75,7	55	Fiyat Sorunuz
BR-1789 M12	150	17,3	12	20,6	1,65	42,2	29,95	16,7	16,8	75,7	55	Fiyat Sorunuz
BR-1789 M16	150	17,3	16	20,6	1,65	42,2	29,95	16,7	16,8	75,7	55	Fiyat Sorunuz
BR-1790 M12	185	19,05	12	22,6	1,78	46,6	33,25	17,35	18,95	82,9	35	Fiyat Sorunuz
BR-1790 M16	185	19,05	16	22,6	1,78	46,6	33,25	17,35	18,95	82,9	35	Fiyat Sorunuz
BR-1791 M16	240	21,55	16	25,2	1,83	54,3	37,25	17,35	17,95	89,6	25	Fiyat Sorunuz
BR-1792 M16	300	24,3	16	29	2,35	53,5	43	22	24,5	100	20	Fiyat Sorunuz
BR-1792 M20	300	24,3	20	29	2,35	53,5	43	22	24,5	100	20	Fiyat Sorunuz
BR-1793 M20	400	27,35	20	32,8	2,73	57,5	48,5	24,8	22,2	104,5	14	Fiyat Sorunuz

Proje Grubu Ürünleri

Profesyonel Aydınlatma Çözümleri

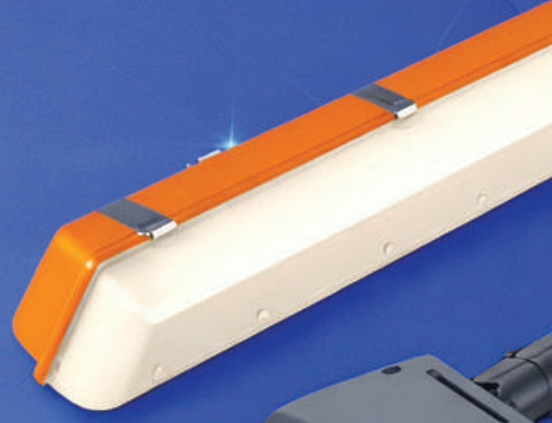



IP20



ALÜMİNYUM



LED

Voltage
85 - 265V
AC
50 - 60 Hz

OSRAM
LEDs
Included



24 Adet

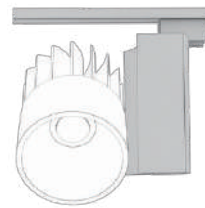

Ø115 mm

IP20



ALÜMİNYUM



LED

Voltage
85 - 265V
AC
50 - 60 Hz

OSRAM
LEDs
Included



24 Adet



Enerji Verimliliği Sınıfı	Ürün Kodu	Güç (W)	Renk Sıcaklığı (K)	Işık Akısı (Lm)	Renk	Fiyat
A	BL-RS-0001	40W	3000 K	4000	Siyah/Black	Fiyat Sorunuz
F	BL-RS-0002		4000 K		Siyah/Black	Fiyat Sorunuz
F	BL-RS-0003		6500 K		Siyah/Black	Fiyat Sorunuz
A	BL-RS-1004	30W	3000 K	3000	Siyah/Black	Fiyat Sorunuz
F	BL-RS-1005		4000 K		Siyah/Black	Fiyat Sorunuz
F	BL-RS-1006		6500 K		Siyah/Black	Fiyat Sorunuz

Enerji Verimliliği Sınıfı	Ürün Kodu	Güç (W)	Renk Sıcaklığı (K)	Işık Akısı (Lm)	Renk	Fiyat
A	BL-RS-1001	40W	3000 K	4000	Beyaz/White	Fiyat Sorunuz
F	BL-RS-1002		4000 K		Beyaz/White	Fiyat Sorunuz
F	BL-RS-1003		6500 K		Beyaz/White	Fiyat Sorunuz
A	BL-RS-1007	30W	3000 K	3000	Beyaz/White	Fiyat Sorunuz
F	BL-RS-1008		4000 K		Beyaz/White	Fiyat Sorunuz
F	BL-RS-1009		6500 K		Beyaz/White	Fiyat Sorunuz



Enerji Verimliliği Sınıfı	Ürün Kodu	Güç (W)	Renk Sıcaklığı (K)	Işık Akısı (Lm)	Ürün Ölçüsü WxLxH mm	Ürün Ölçüsü ØxH mm	Kesim Ölçüsü (Çap/Ø)	Fiyat
A G F	BL-PRJ-0001	50W	3000 K	8000	535 x 210 x 110	55	3	Fiyat Sorunuz
A G F	BL-PRJ-0002		4000 K		535 x 210 x 110	55	3	Fiyat Sorunuz
A G F	BL-PRJ-0003		6500 K		535 x 210 x 110	55	3	Fiyat Sorunuz
A G F	BL-PRJ-0004	100W	3000 K	16000	605 x 265 x 110	55	3	Fiyat Sorunuz
A G F	BL-PRJ-0005		4000 K		605 x 265 x 110	55	3	Fiyat Sorunuz
A G F	BL-PRJ-0006		6500 K		605 x 265 x 110	55	3	Fiyat Sorunuz
A G F	BL-PRJ-0007	150W	3000 K	24000	710 x 265 x 110	55	3	Fiyat Sorunuz
A G F	BL-PRJ-0008		4000 K		710 x 265 x 110	55	3	Fiyat Sorunuz
A G F	BL-PRJ-0009		6500 K		710 x 265 x 110	55	3	Fiyat Sorunuz
A G F	BL-PRJ-0010	200W	3000 K	32000	760 x 265 x 110	55	2	Fiyat Sorunuz
A G F	BL-PRJ-0011		4000 K		760 x 265 x 110	55	2	Fiyat Sorunuz
A G F	BL-PRJ-0012		6500 K		760 x 265 x 110	55	2	Fiyat Sorunuz
A G F	BL-PRJ-0013	300W	3000 K	48000	810 x 265 x 110	55	2	Fiyat Sorunuz
A G F	BL-PRJ-0014		4000 K		810 x 265 x 110	55	2	Fiyat Sorunuz
A G F	BL-PRJ-0015		6500 K		810 x 265 x 110	55	2	Fiyat Sorunuz



IP54

OSRAM

LEDs
Included



LED



ALÜMİNYUM



1 Adet



Enerji Verimliliği Sınıfı	Ürün Kodu	Güç (W)	Renk Sıcaklığı (K)	Işık Akısı (Lm)	Ürün Ölçüsü WxLxH mm	Opsiyonlar	Fiyat
A+G	BL-Y1-0007	110W	3000 K	13200	132x1200x75	-	Fiyat Sorunuz
A+G	BL-Y1-0007-3H		3000 K		132x1200x75	3 Saat Acil Kit	Fiyat Sorunuz
A+G	BL-Y1-0008		4000 K		132x1200x75	-	Fiyat Sorunuz
A+G	BL-Y1-0008-3H		4000 K		132x1200x75	3 Saat Acil Kit	Fiyat Sorunuz
A+G	BL-Y1-0009		6500 K		132x1200x75	-	Fiyat Sorunuz
A+G	BL-Y1-0009-3H		6500 K		132x1200x75	3 Saat Acil Kit	Fiyat Sorunuz
A+G	BL-Y1-0010	135W	3000 K	16200	132x1500x75	-	Fiyat Sorunuz
A+G	BL-Y1-0010-3H		3000 K		132x1500x75	3 Saat Acil Kit	Fiyat Sorunuz
A+G	BL-Y1-0011		4000 K		132x1500x75	-	Fiyat Sorunuz
A+G	BL-Y1-0011-3H		4000 K		132x1500x75	3 Saat Acil Kit	Fiyat Sorunuz
A+G	BL-Y1-0012		6500 K		132x1500x75	-	Fiyat Sorunuz
A+G	BL-Y1-0012-3H		6500 K		132x1500x75	3 Saat Acil Kit	Fiyat Sorunuz



IP65

50.000h

IK 03

LED



Ex

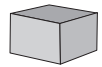

1 Adet

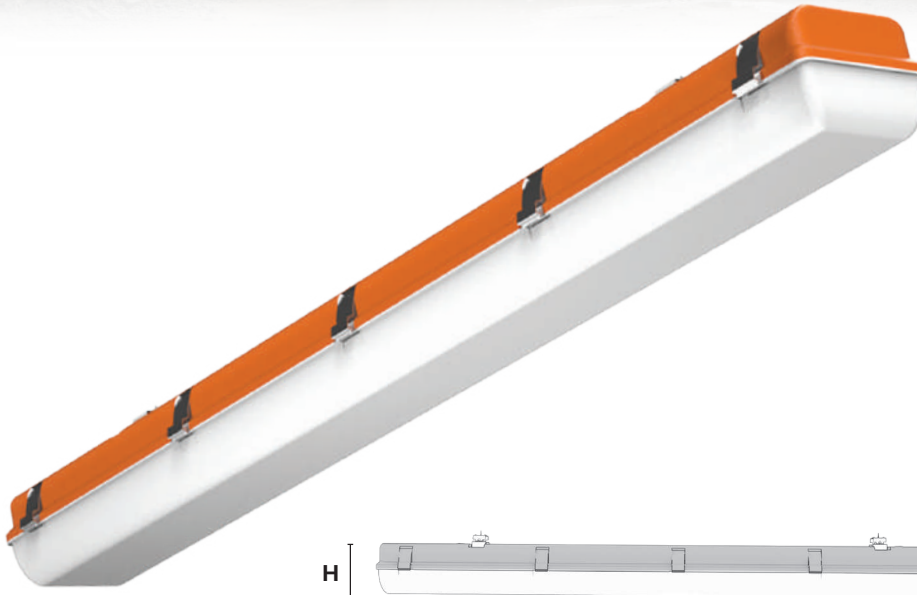

H

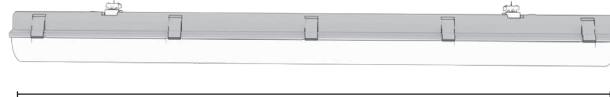

L

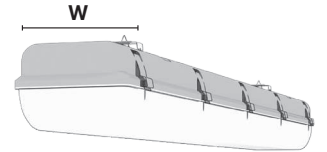

Enerji Verimliliği Sınıfı	Ürün Kodu	Güç (W)	Renk Sıcaklığı (K)	Işık Akısı (Lm)	Ürün Ölçüsü WxLxH mm	Renk	Fiyat
A B F	BL-EX-0001	20W	3000 K	2200	95 x 670 x 125	Turuncu	Fiyat Sorunuz
A B F	BL-EX-0002		4000 K		95 x 670 x 125		Fiyat Sorunuz
A B F	BL-EX-0003		6500 K		95 x 670 x 125		Fiyat Sorunuz
A B F	BL-EX-0004	40W	3000 K	4400	95 x 1270 x 125	Turuncu	Fiyat Sorunuz
A B F	BL-EX-0005		4000 K		95 x 1270 x 125		Fiyat Sorunuz
A B F	BL-EX-0006		6500 K		95 x 1270 x 125		Fiyat Sorunuz
A B F	BL-EX-0007	60W	3000 K	6600	95 x 1270 x 125	Turuncu	Fiyat Sorunuz
A B F	BL-EX-0008		4000 K		95 x 1270 x 125		Fiyat Sorunuz
A B F	BL-EX-0009		6500 K		95 x 1270 x 125		Fiyat Sorunuz



LED ACİL ÇIKIŞ ARMATÜRÜ - YUKARI YÖNLÜ
LED EMERGENCY EXIT LIGHT - UPWARD DIRECTION

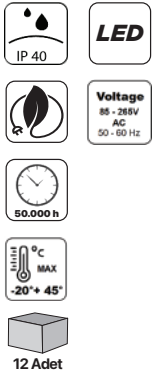

Ürün Kodu	Güç (W)	Işık Akısı (Lm)	Giriş Voltajı	Ürün Ölçüsü WxLxH mm	Fiyat
BL-AC-0004	3W	120	220-230 V AC	195 x 325 x 55	Fiyat Sorunuz

LED ACİL ÇIKIŞ ARMATÜRÜ - AŞAĞI YÖNLÜ
LED EMERGENCY EXIT LIGHT - DOWNWARD DIRECTION

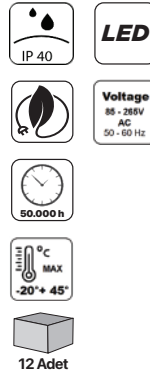

Ürün Kodu	Güç (W)	Işık Akısı (Lm)	Giriş Voltajı	Ürün Ölçüsü WxLxH mm	Fiyat
BL-AC-0002	3W	120	220-230 V AC	195 x 325 x 55	Fiyat Sorunuz

LED ACİL ÇIKIŞ ARMATÜRÜ - İLERİ YÖNLÜ
LED EMERGENCY EXIT LIGHT - FORWARD DIRECTION

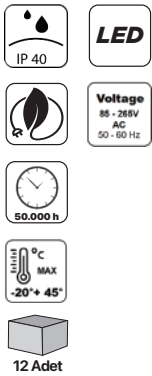

Ürün Kodu	Güç (W)	Işık Akısı (Lm)	Giriş Voltajı	Ürün Ölçüsü WxLxH mm	Fiyat
BL-AC-0003	3W	120	220-230 V AC	195 x 325 x 55	Fiyat Sorunuz

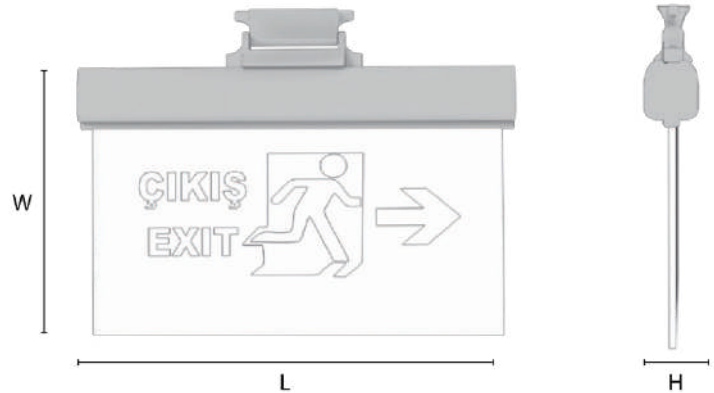



IP20



LED

50.000 h

ALÜMİNYUM

°C MAX
-20*+ 45*

Voltage
85 - 265V
AC
50 - 60 Hz



IK 03

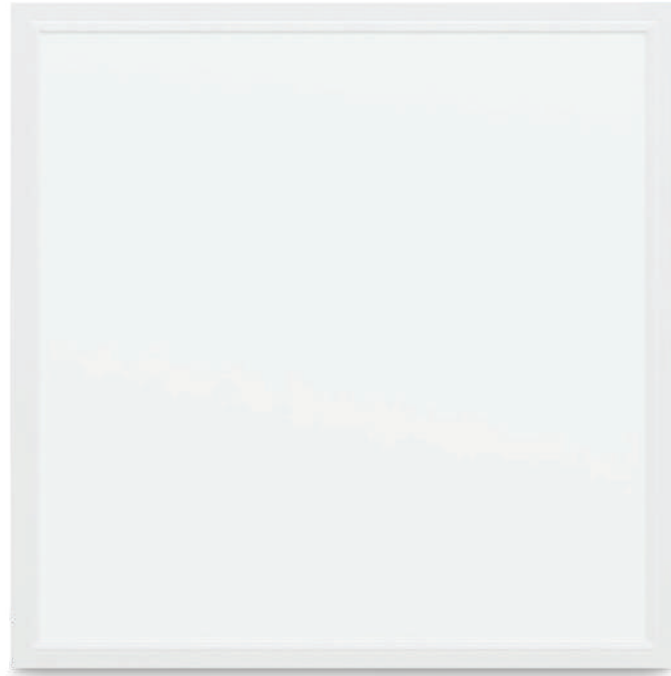

Enerji Verimliliği Sınıfı	Ürün Kodu	Güç (W)	Renk Sıcaklığı (K)	Işık Akısı (Lm)	Koli Adetleri	Ürün Ölçüsü WxLxH mm	Fiyat
A	BLT-02-2002	36W	4000 K	4500	2 Adet	600 x 600 x 65	Fiyat Sorunuz
A	BLT-02-2003		6500 K		2 Adet	600 x 600 x 65	Fiyat Sorunuz





LED Opal Backlight Panel

Modern mimari için entegre, enerji tasarruflu çözümler



LED OPAL LENSİ BACKLIGHT CLIP-IN ARMATÜR LED BACKLIGHT CLIP-IN ARMATURE - OPAL LENS

LED OPAL LENSİ BACKLIGHT SIVA ÜSTÜ ARMATÜR LED SURFACE MOUNTED BACKLIGHT ARMATURE - OPAL LENS

IP20

Voltage
85 - 265V
AC
50 - 60 Hz

Sanan
LEDs
Included

50.000 h

LED

°C MAX
-20° + 45°

IK 02



DRIVERLI

IP20

Voltage
85 - 265V
AC
50 - 60 Hz

Sanan
LEDs
Included

50.000 h

LED

°C MAX
-20° + 45°

IK 02



DRIVERLI

Enerji Verimliliği Sınıfı	Ürün Kodu	Güç (W)	Renk Sıcaklığı (K)	Işık Akısı (Lm)	Koli Adetleri	Ürün Ölçüsü ØxH mm	Fiyat
A E	BLT-O2-2008	36W	4000 K	4500	2 Adet	600x600x65	Fiyat Sorunuz
A E	BLT-O2-2009		6500 K		2 Adet	600x600x65	Fiyat Sorunuz

Enerji Verimliliği Sınıfı	Ürün Kodu	Güç (W)	Renk Sıcaklığı (K)	Işık Akısı (Lm)	Koli Adetleri	Ürün Ölçüsü ØxH mm	Fiyat
A E	BLT-O5-2008	36W	4000 K	4500	2 Adet	600x600x65	115,80 \$
A E	BLT-O5-2009		6500 K		2 Adet	600x600x65	115,80 \$



YERLİ ÜRÜN

HAVA KAÇAK TESPİT CİHAZI

Profesyonel Çözümler



HAVA KAÇAK TESPİT CİHAZI

Entegre kameralı ultrasonik hava kaçak dedektörü tamamen yerli üretilmiştir. Endüstriyel ve gürültülü ortamlarda akustik huni yapısı ile gelişmiş ve hassas kaçak tespiti için tasarlanmıştır. Sağlam gövde ve ergonomik yapısı ile düşük ağırlıkta ve dokunmatik ekran üzerinde kolay kullanım özelliğine sahiptir.

Kaçak verilerini depolama ve bilgisayara aktarma özelliğinin yanı sıra; görüntülenen kaçak oranını L/dk cinsinden direkt görüntüleme, maliyet hesaplama ve raporlama özelliklerine sahip fonksiyonel bir cihazdır.



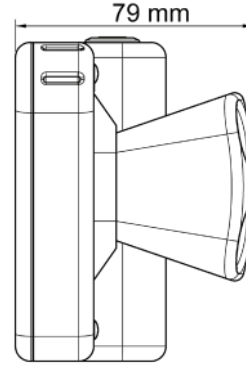
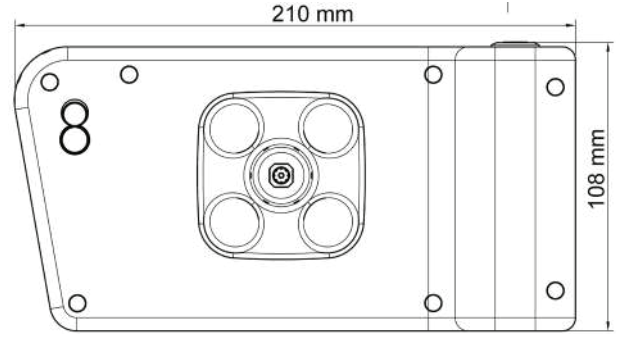

Gövde	Mikrofon Sayısı	Mikrofon Frekans Bandı	Batarya	Ağırlık (Pili Dahil)	Görüş Alanı
ABS	4 adet Dijital MEMS	20-60 kHz	Şarj Edilebilir Batarya / 4 Saat Kullanım	550 gr	65°
Çözünürlük	Dokunmatik Ekran	Akustik Görüntü	dB Kazanç Grafik Geçişi	Konum Kaydetme	
480x272 (130.560 piksel)	Kapasitif	Evet	Otomatik	Fotoğraflandırma ve Not Yazma	



Seviye hassasiyetini otomatik olarak ayarlar. Endüstriyel ortamdan ve ortam gürültüsünden etkilenmeden güvenilir ölçüm ve yaklaşık ve en doğru kaçak hava maliyetleri gösterilmesini sağlar. Toplam kaçak miktarınız ve toplam kaçak maliyetleriniz hakkında genel bir bakış sağlar ve sizi gerekli denetimlere hazırlar.

Automatically adjusts the level sensitivity. Reliable measurement and display of approximate and most accurate leakage air costs without interference from the industrial environment and ambient noise. Provides an overview of your total leakage amount and total leakage costs and prepares you for necessary audits.

Boru sistemlerindeki sızıntılar, hava kaçaklarında (örneğin korozyon, sızıntı yapan vida bağlantıları vb.) ultrasonik aralıkta bir miktar gürültü üretir. HAVA KAÇAK TESPİT CİHAZI, insan kulağının birkaç metre mesafeden bile duyamayacağı bu tipteki en küçük kaçakları gürültülü ortama rağmen tespit eder ve ultrason verilerini duyulabilir ve izlenebilir frekanslara dönüştürür. Son derece hassas sensör teknolojisi ile bu tür kaçakların (örneğin basınçlı hava sistemleri, endüstriyel tesislerdeki pnömatik sistemler) tespitinde ileri düzeyde destek sağlar. Entegre sistemleri sayesinde lazer işaretleyici bir hedefleme cihazı olarak işlev görür, sızıntı daha hassas bir şekilde konumlandırılabilir ve lokalize edilebilir. Sızıntı verileri bir SD kart üzerinden aktarılabilir ve bulunan sızıntıları belgelemek için net raporlar oluşturulabilir.

Leaks in piping systems, air leaks (e.g. corrosion, leaking screw connections, etc.) produce some noise in the ultrasonic range. The AIR LEAK DETECTOR detects the smallest leaks of this type, which the human ear cannot hear even at a distance of several metres, despite the noisy environment and converts the ultrasound data into audible and traceable frequencies. With its highly sensitive sensor technology, it provides advanced support in the detection of such leaks (e.g. compressed air systems, pneumatic systems in industrial plants). Thanks to its integrated systems, the laser pointer functions as a targeting device and the leak can be more precisely located and localised. Leak data can be transferred via an SD card and clear reports can be generated to document found leaks.

Aydınlatmada Kullanılan Lambalar

Günümüzde aydınlatmada kullanılan lambalar aşağıdaki gibidir. Önceki yıllarda yapılmış olan aydınlatma sistemleri civa buharlı lambalar yoğun olarak kullanılmaktadır. Günümüzde ise Tedaş'ın şartnamelerinde Civa buharlı lamba kullanımı yasaklanmıştır. Aşağıdaki tablodan da görüldüğü üzere teknoloji sürekli olarak gelişmekte daha yüksek ışık etkinliğine sahip ve daha uzun ömürlü ürünler seçilmektedir.

Lamba Türü	Işık Etkinliği (Lm/W)	Ömür (Saat)
Akkor lamba (Enkandesen)	8 - 16	1000
Halojen lamba (Tungsten)	12 - 26	2.000 - 4.000
Floresan lamba	45 - 100	6.000 - 15.000
Yb Civa Buharlı lamba	36 - 60	6.000 - 8.000
Metal Halide lamba	71 - 98	5.600 - 6.500
Endüksiyon	68 - 72	5.800 - 6.200
YB Sodyum Buharlı lamba	66 - 142	10.000 - 15.000
AB Sodyum Buharlı lamba	100 - 198	11.500 - 20.000
LED	80 - 165	50.000 - 100.000

Işık Akısı (LM)

Bir ışık kaynağından ışığın akının göze etkiyen kısmına ışık akısı denir. Birimi lümen dir ve ışının parlaklık duygusu uyandırma yeteneğini temsil eder. Toplam ışık akısı ise bir kaynaktan çıkan ve uzayın muhtelif kısımlarına yayılan ışık akılarının toplamı olarak tanımlanır. Işık enerjisinin ölçüsüdür. Diğer bir deyişle, bir ışık kaynağından toplam çıkış lümenle ifade edilir. Lümen ne kadar yüksek ışık ise o kadar parlak gözükür. (1 lümen = 0.00146 W)

Aydınlık Düzeyi (Lux)

Birim yüzeye düşen toplam ışık akısı o yüzeyin aydınlık düzeyi olarak tanımlanır ve E ile gösterilir. Birimi lux'tür. Bir Lux'un ışıma gücü bir mum ışığına eş değerdir.

Renk Sıcaklığı (Color Temperature K)

Beyaz ışınım yapan bir ışık kaynağının sahip olduğu ışığın rengini ifade eder. Genelde eski tip enkandesan ampuller 2500K ışık rengine sahiptir. Bunun dışında 2700K sarı ışık, 3000K gün ışığı (veya sıcak beyaz), 4000K nötr beyaz, 5000-6500K soğuk beyaz ışık rengi olarak tabir edilir.

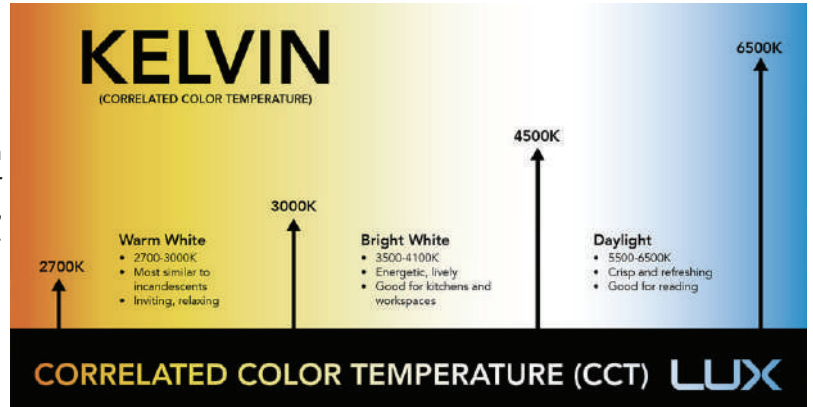

Renksel Geri Verim (CRI)

Renksel Geri Verim nesnenin belli bir ışık kaynağı altında renk kalitesini ifade eder. Yüksek CRI değerine sahip bir ışık kaynağı, renklerin daha doğal görünmesini ifade eder. Değer, 0 (çok zayıf renk sunumu) ile 100 (mükemmel renk sunumu) arasında değişmektedir. Genel olarak 80 CRI olan ışık kaynakları uygun olarak kabul edilir.



Işık Şiddeti (Cd)

Noktasal bir ışık kaynağının herhangi bir doğrultusundaki ışık şiddeti bu doğrultuyu içine alan uzay açısından çıkan ışık akısının uzay açığı bölümü olarak tanımlanır. Birimi Candela'dır ve 'cd' ile gösterilir. 1 Lümenlik ışık akısının 1 steradyanlık uzay açısından çıkması durumunda ışık şiddeti 1 cd olur.

Işık

Dalga teorisine göre ışık elektromanyetik ışınlanma (radyasyon) enerjisinin gözle görülebilen bir şeklidir. Belli bir yayılma hızına frekansa ve dalga boyuna sahiptir. İnsanoğlu bu elektromanyetik dalgaların sadece dalga boyu 380 nm ile 780 nm arasında değişen ve renk olarak tanımlanan kısmını görebilir.

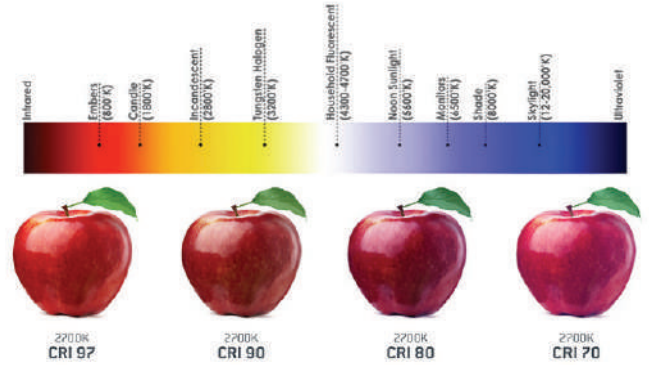

Renk

Farklı dalga boylarındaki ışınların insan beyinde yaptığı çağrışımlardır. Bir ışık demetinin rengini tayfsal özellikleri belirler.

ELECTROMAGNETİK SPECTRUM

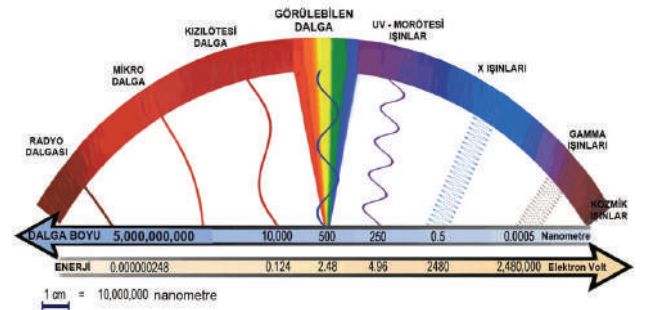

Konik Diagram

Aydınlatma ürününden çıkan ışık akısının baz alınan belli yükseklikler için ne kadarlık ışık şiddeti (lx) oluşturacağı belirtilmektedir. Aşağıdaki tabloda 90 Derece Açığı ile kullanılan armatürlerin farklı yüksekliklerde zemine vurma dağılımı gösterilmektedir. Hesaplama sonucu oluşturulan diagramda ortam koşulları hesaplamalara dahil edilmemiştir.

0.5	1.49	E(0°) E(C0)	2018 174
1.0	2.99	E(0°) E(C0)	504 43
1.5	4.48	E(0°) E(C0)	224 19
2.0	5.98	E(0°) E(C0)	128 11
2.5	7.47	E(0°) E(C0)	81 7
3.0	8.96	E(0°) E(C0)	58 5

Distance [m] Cone Diameter [m] Illuminance [lx]
C0 - C180 (Half value angle: 112.4°)

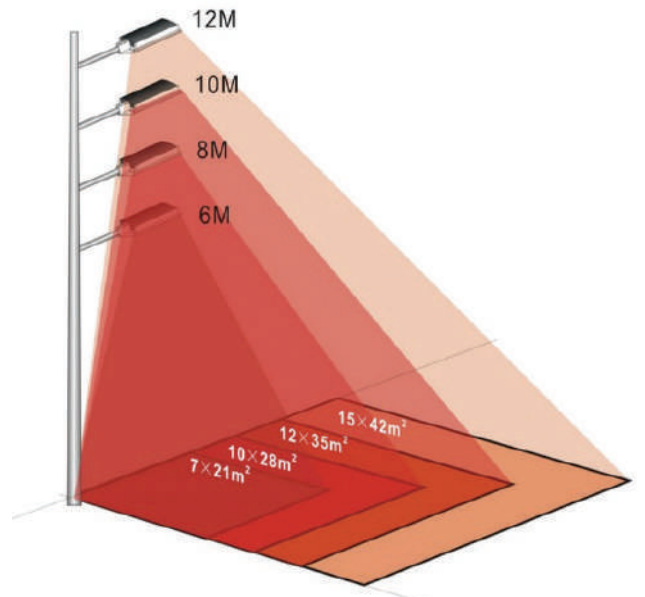

Types of Light Lamps

The lighting lamps in use today are shown below table. Mercury vapor lamps were used intensively in lighting systems. As you may see from following table, technology is always improving therefore long life energy-saving and higher lighting efficiency products are being preferred.

Types of Lamps	Light efficiency (lm/W)	Lifetime (hour)
Incandescent Lamps	8 - 16	1000
Halojen Lamps (Tungsten)	12 - 26	2.000 - 4.000
Floresan Lamps	45 - 100	6.000 - 15.000
High-pressure	36 - 60	6.000 - 8.000
Mercury-vapor Lamps	71 - 98	5.600 - 6.500
Induction	68 - 72	5.800 - 6.200
High Pressure Sodium Lamps	66 - 142	10.000 - 15.000
Low Pressure Sodium Lamps	100 - 198	11.500 - 20.000
LED	80 - 165	50.000 - 100.000

Luminous Flux (LM)

The amount of light (energy) as seen by the human eye that is given off by the light bulb described as luminous flux. It is designated by the symbol F and is expressed in lumens and total luminous flux is described as sum amount of the luminous flux that emitted by a light source and spread into space sundry parts. It is unit of light energy. In other words, total outcome from a light source stated by Lumen. More lumens means it's a brighter light. (1lm=0,00146 W)

Luminous Level (Lux)

Illuminance level is the quantity of total luminous flux falling on unit area of a surface and It is designated by the symbol E. Its unit is lux. One lux equals to a candle light.

Colour Temperature (K)

Defines the color of light of a light source which emits white radiation. Old type incandescent lamps have usually 2500 K light colour. Besides that 2700 K is expressed yellow light, 3000 K is daylight(or warm white), 4000 K is pure white, 5000-6000 K is cool white.

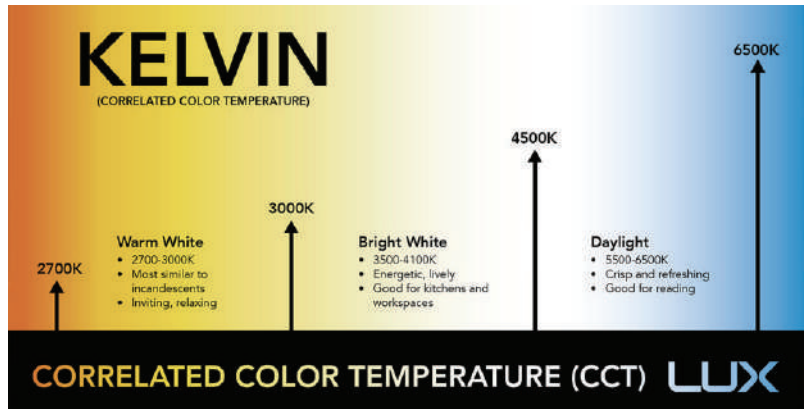

Color Rendering Index (CRI)

Colour rendering index measures the objects appear under a given light source. A light with a high CRI rating will allow an object's colours to be appeared more natural. Value of the CRI is ranging from 0 (very poor color rendition) to 100 (nearly perfect color rendition). Light sources with CPI over 80 are considered excellent for colour recognition.



Luminous Intensity (Cd)

Concentration of light emitted in a specific direction per unit time. Unit is the Candela and shown 'cd'. 1 cd luminous intensity is equal to 1 lm luminous flux emitted in 1 steradian space angle.

Light

According to wave theory, light is the way electromagnetic radiation energy that are seen to human eye. It has a specific radiation speed, frequency and wavelength. Only electromagnetic wavelengths between 380 nm and 780 nm and defined as colours are visible to human eye.

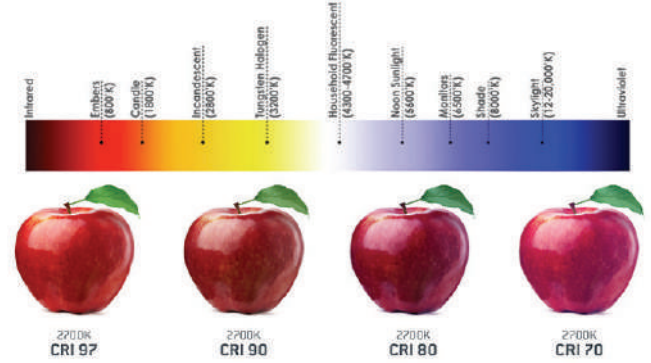

Colour

Associations of different wavelength light beam in the human brain defined as colour. The colour of a light beam is determined by spectrum.

ELECTROMAGNETİK SPECTRUM

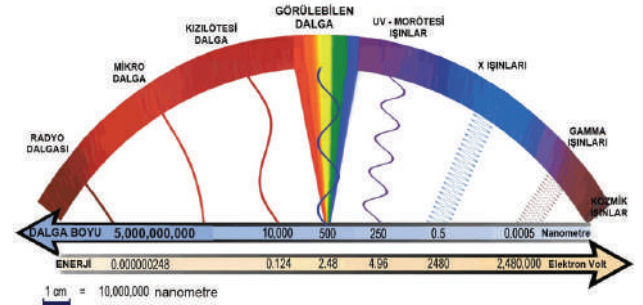

Conic Diagram

It specifies how much luminous intensity (lx) is to be produced based on certain heights by light output of lighting products. The following table shows the distribution of light hitting at different heights of Luminaires with 90 Degree Angle. Environmental conditions are not included in calculations of diagram.

0.5	1.40	E(0°) E(C0)	56.2°	2018 174
1.0	2.90	E(0°) E(C0)	56.2°	504 43
1.5	4.48	E(0°) E(C0)	56.2°	224 19
2.0	5.98	E(0°) E(C0)	56.2°	128 11
2.5	7.47	E(0°) E(C0)	56.2°	81 7
3.0	8.96	E(0°) E(C0)	56.2°	56 5

Distance [m] Cone Diameter [m] Illuminance [lx]
 — C0 - C180 (Half value angle: 112.4°)

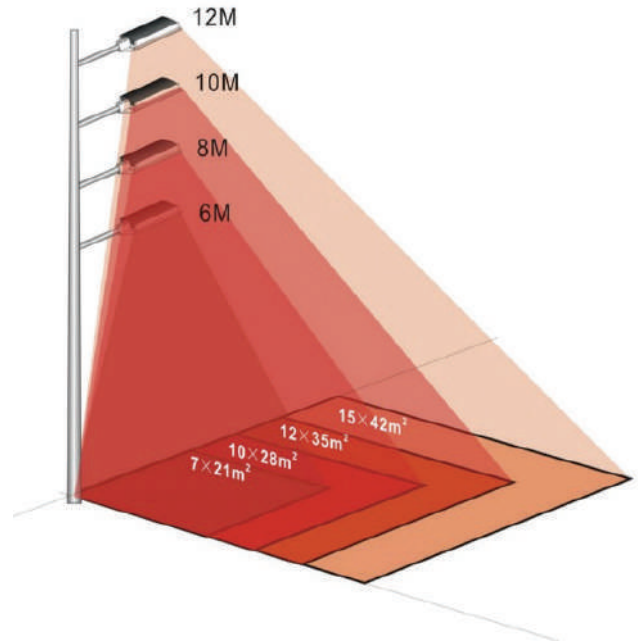







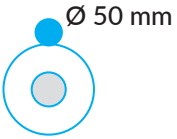
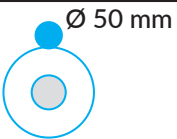
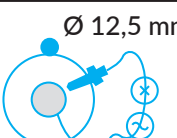
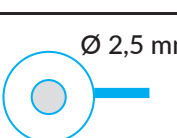
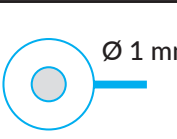
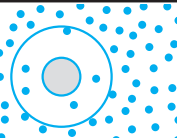
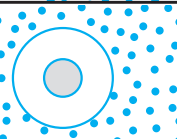





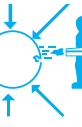



















IP Koruma Sınıfı / Ingress Protection Rating (IP)

IP Kodu armatürlerin katı ve sıvı cisimlere karşı koruma göstergesidir. IP Koruma sınıfları iki rakamla gösterilir. Birinci rakam katı cisimlere karşı ikinci rakam ise sıvılara karşı korumayı gösterir. Koruması yüksek aydınlatma armatürlerinin iç kesimleri daha temiz olacağından armatürlerin reflektörleri daha iyi bir verim sağlayacaktır.

IP Code is a protection indicator of Luminaires against solid and liquid substances. IP Protection classes are indicated by two digits. The first number is against solid objects and the second number shows protection against liquids. High protected luminaires reflectors will provide better efficiency because of their cleaner inner parts.

Birinci Rakam / First Number Katı cisimlere karşı koruma / Degree of Protection (Solids)		
IP	Testler	
0		Korumasız Non Protection
1		50 mm ² 'den büyük boyutlardaki katı cisimlerden koruma Protection against large foreign bodies (diameter < 50mm ²)
2		12.5 mm ² den büyük boyuttaki katı cisimlerden koruma Protection against medium foreign bodies (diameter < 12.5mm ²)
3		2.5 mm ² den büyük boyuttaki katı cisimlerden koruma Protection against small foreign bodies (diameter < 2.5mm ²)
4		1 mm ² den büyük boyuttaki katı cisimlerden koruma Protection against small foreign bodies (diameter < 1mm ²)
5		Tozlardan koruma Dust Protected
6		Tozlara karşı tamamı ile koruma Dust-tight

İkinci Rakam / Second Number Sıvı cisimlere karşı koruma / Degree of Protection (Water)		
IP	Testler	
0		Korumasız Non Protection
1		Düşey olarak akan su damlalarından koruma Protection against vertical water drops
2		Düşey'le 15° lik açı yapan su damlalarından koruma Protection against inclined water drops (15° from vertical)
3		Düşey'le 60° lik açı yapan su damlalarından koruma Protection against splash water drops (60° from vertical)
4		Her yönden gelen su damlalarından koruma Protection against splash water from all directions
5		Her yönden hortum marpuçundan püsküren su fışkırtmalarından koruma Protection against water jets from any angle
6		Her yönden. deniz dalgalarına benzer şekilde çarpan suların etkisine karşı tam koruma Protection against temporary flooding
7		Suya gömülme durumunun etkilerinden koruma Protection against water submersion to 1m for 30 min
8		Belirlenmemiş koşullar altında uzun sürelerde suya gömülme durumunun etkilerinden koruma Protection against high pressure water and submersion for an indefinite time

Sembol <i>Symbol</i>	Açıklama <i>Explanation</i>	Sembol <i>Symbol</i>	Açıklama <i>Explanation</i>
	Türk Standartlarına Uygunluk Belgesi <i>Turkish Standard Compliance Certificate</i>		Yanıcı Yüzeyle Monte Edilebilir <i>Can be Mounted to flammable surfaces</i>
	Kalite Sistem Belgesi <i>Quality System Certification</i>		I.Sınıf Gövde Koruma Topraklanmış <i>1.Class of protection. The body is grounded.</i>
	ISO 14001 Kalite Sistem Belgesi <i>ISO 14001 Quality System Certification</i>		Geri Dönüşüme Uygundur <i>Suitable for recyCeiling</i>
	OHSAS 18001 Kalite Sistem Belgesi <i>OHSAS 18001 Quality System Certification</i>		Yetkili Personel Tarafından Müdahale Edilmeli <i>Must be intervened by authorized personnel</i>
	ROHS Uygunluk Sertifikası <i>RoHS Compliance Certificate</i>		IP20 Koruma Sınıfı <i>Protection Class IP 20</i>
	CE Deklarasyon Belgesi <i>CE Declaration Document</i>		IP65 Koruma Sınıfı <i>Protection Class IP 65</i>
	EAC Gümrük Birliği Belgesi <i>EAC Custom Union Certificate</i>		Eğitim Kurumları <i>Educational Institutions</i>
	Ukrayna Standartlarına Uygunluk Belgesi <i>Ukrainian Standards Compliance Certificate</i>		Yaşam Alanı <i>Living Space</i>
	Rusya Standartlarına Uygunluk Belgesi <i>Russian Standards Compliance Certificate</i>		Endüstriyel Tesisler <i>Industrial Plants</i>
	Avrupa Standartlarına Uygunluk Belgesi <i>European Standards Compliance Certificate</i>		Alışveriş Merkezleri <i>Shopping Malls</i>
	Enerji Tasarrufu <i>Energy Saving</i>		Sağlık Kuruluşları <i>Health Institutions</i>
	Alev İletmeyen Ham madde <i>Halogen Free</i>		Dış Mekan <i>Outdoor</i>
	Şebeke Gerilimi (220V) ile Çalışır <i>Works with mains voltage (220V)</i>		

	LUX		LUX
KONUTLAR		X rayonu servisi (ayarlanabilir aydınlatma)	80
Oturma Odaları	500	Dişle ilgili servis büro için (genel aydınlatma)	250
Mutfaklar	250	Hasta koltuğu	5000
Yatak Odaları	250	WC	50
Giriş holü merdivenler çatı karı ambar garajlar	250	Doğum Servisi	
BÜROLAR		Annelerin yatakları	5000
Resim büroları kadastro harita	2500	Çalışma salonu (genel aydınlatma)	250
Projeler teknik resim mimari	750	Çocukların odası	100
Dekoratif resim ve krokiler	500	Bekleme salonları	100
Muhasebe ile ilgili aygıtlar	500	Hastaneler için özel odalar (genel aydınlatma)	50
Hesaplamalar	400	Yatak aydınlatması	200
Daktilo odası	500	HOTEL VE RESTORANLAR	
Belgelerin bulunduğu salon	100	Banyolar	100
Yönetim büroları	250	Aynalar (ek aydınlatma)	200
Bekleme salonları	150	Hol ve merdivenler	50
Konferans salonları	200	Mutfaklar	250
Kantinler	150	Odalar	150
OKULLAR		Yatak ucu aydınlatması	150
Yuvalar anaokulları	100	Büro masası	200
Sınıflar	200	Tuvalet masası	250
Jimnastik salonları	100	Önemli Mekanlar	
İlkokullar sınıflar	250	Konferans salonları	75
Deney sınıfları	300	Platform	200
Toplantı salonu	150	Sergileme ve tanıtımlar	150
Jimnastik salonu	150	Salonlar	50
Meslek Okulları	400	Restorantlar	75
İlk ve ortaokul düzeyindeki teknik okullar		Barlar	75
Sınıflar	250	ÇAMAŞIRHANE	
Resim sınıfları	400	Yıkama yeri	150
Atölyeler	250	Onarım sayım işaret	200
HASTANELER		Özel parça onarımı	400
Doktor Odaları	100	CAM FABRİKASI	
Çalışma masaları	400	Karıştırma	150
Genel aydınlatma	150	Fırınlama.soğutma	150
Dispanser masaları	400	Mak. İşleme salonu	150
Yedek odalar	150	Ölçüye göre kesme	200
Toplantı odası	100	Parlatma	200
Laboratuvarlar		Pahlandırma	400
Araştırma salonları	250	Gravür işleme	500
Çalışma masaları	400	Kontrol	750
Tanı ve terapi odaları(genel aydınlatma)	250	ÇELİK FABRİKASI	
Tanı masası	500	Haddehane	150
Operasyon odası (genel aydınlatma)	500	Boru çubuk tel im.	200
Operasyon masası	20000	Galvanizasyon	200
Sterilizasyon odası	400	Makine dairesi	150

	LUX		LUX
Kalite kontrol	400	Denetleme ve lekelerin çıkarılması	1500
YÜKSEK FIRIN		Ütüleme	
Kömür ve cevher deposu	50	Makine ile ya da elle	500
Yükleme	100	Katlama ve üzerinde değişiklikler yapma	750
Kontrol kapak ları	150	TEKSTİL SANAYİ	
Fırın kapakları bakımı	100	Pamuk	
Demir kütük deposu	50	Pamukların açılıp karıştırılması ayrılması	100
Çelik fabrikası	150	Tarama makaradan geçirme iplik durumuna getirme	200
KERESTE FABRİKASI		Haddeden geçirme	400
Makine ile ilk kesme	150	Denetleme	
Y. Hassas işleme	200	Sabit parçalar	400
Hassas işleme	400	Hareketli (hızlı) parçalar	1500
KAYNAK		İpek ve sentetik telli kumaşlar	100
Genel aydınlatma	250	Koyu renkli ipliklerle çalışma	750
Hassas ark kaynağı	2500	Dokuma	400
DÖKÜMHANE		Yün	
Maça imali (Hassas)	350	Yünlerin açılıp karıştırılması ayrılması	100
Maça imali (Kaba)	200	Denetleme	400
Döküm salonu	200	Tarama, çekip uzatma, çirileme mekik geçirme	200
Temizleme parit	200	Haddeden geçirme	
Kontrol		Beyaz	200
AYAKKABI FABRİKASI		Renkli	400
Kesim ve seçme	1000	Dokuma	
Model hazırlanması	1000	Beyaz	400
İnce kesim	1000	Renkli	750
Kauçuk hazırlama	125	SERAMİK SANAYİ	
Vernikleme	200	Öğütme, filtreleme ve kurutma kompanzasyonu	100
Volkanize kesme	200	Formlama, bitirme ve temizleme	150
Taban hazırlama	400	Reklendirme ve parlatma	400
MAKİNE ATÖLYELERİ		Reklendirme ve parlatma (İnce detaylar)	750
Kaba işleme	250	MAĞAZALAR	
İnce işleme ve parlatma	400	Vitrinler	1000
Çok ince işleme	2500	Büyük kentlerdeki satın alma merkezleri (Genel aydınlatma)	1000
GİYİM SANAYİ		Spotla ek aydınlatma	5000
Kumaşların denetimi		Diğer yerlerde (Genel aydınlatma)	500
Açık renkli kumaşlar	1500	Spotla ek aydınlatma	2500
Koyu renkli kumaşlar	2500	Mağaza iç mekanı	
Kesim ve Ütüleme	750	Büyük mağazalar	1000
Açık renkli kumaşlar	500	Büyük kentlerin ticaret merkezleri	1000
Koyu renkli kumaşlar	1000	Diğer yerler	500
Dikme ve Çeşitlendirme	750	Genel mağazalar (Az uğranan bölümler)	250
Açık renkli kumaşlar	750	Fabrika mağazaları (Çok uğranılan bölümler)	300
Koyu renkli kumaşlar	1500	Büyük parçaların yeri	100
BOYAMA		Küçük parçaların yeri	200
Belirginleştirme ayırma yıkama temizleme	200	Çok küçük parçaların yeri	300

	LUX		LUX
Müzeler	150	Park yerleri	50
Tablolar (bölgesel aydınlatma)	750	Sergileme salonları	400
Heykel ve diğer nesnelere	400	OTOMOBİL FABRİKALARI	
TİYATROLAR		Şasilerin toplanması.birleştirilmesi	200
Giriş ve fuaye	200	Şasilerin dizilimi	400
Salon	50	Döşemenin yapımı.çeşitli parçaların toplanıp birleştirilmesi	300
Orkestra yeri	100	Genel birleştirme	400
İbadethane	80	Bitirme ve denetleme	750
SİNEMALAR		Boya Fabrikaları	150
Giriş ve kasa	200	MATBAA	
Fuaye	50	Matris imali	400
Salon	100	Harflerin hazırlanması	200
SPOR SALONLARI		Renk ayırımı	
Stad	200	Baskı yeri	250
Futbol alanı	100	Mizampaj masası	500
Antreman alanı	25	KAĞIT FABRİKASI	
Tenis kortu	250	Karıştırma odası	150
Paten sahası	15	Kağıt makineleri	200
Paten sahası/yarışmalar için)	40	Kesme dek.	200
EKMEK FIRINLARI		Kontrol laboratuvarı	400
Karışım salonları	200	KİMYA SANAYİ	
Hamur reyonları	125	Elle çalıştırılan fırınlar sabit kurutucular ve kristalizasyon kapları	150
Fermantasyon salonu	125	Ototomatik fırınlar buharlı kazanlar damıtma kolonları	150
Hazırlama salonu	200	Koyulaştırma kazanları nitasyon elektroliz	150
Fırınların bulunduğu salon	150	UÇAK ENDÜSTRİ	
Süsleme ve soğutma	250	Kaynak cıvata ve taşlama	250
Ambalaj salonu	150	Boya kabini	400
DEĞİRMENLER		Parçaların işlenmesi	400
Karıştırma tem.	200	İnce kaynak	250
Ambalaj salonu	100	Montaj	400
Mamul kontrolü	400	İşin tamamlanması	400
Silo temizliği	100	Kanat ve parça montajı	400
TREN İSTASYONLARI		UÇAK HANGARI	
Bekleme salonları	100	Bakım yeri	250
Bilet alma ve büroların bulunduğu yerler	400	Motor bakımı	400
Serinleme ve dinlenme salonları	150	SABUN ENDÜSTRİSİ	
Bavul emanet yeri	200	Toz sabun imali	150
Peronlar	100	Markalama paket	150
WC	100	Kalıplama ambalaj	250
GARAJLAR		TÜTÜN FABRİKASI	
Atölye	250	Kurutma	150
Tezgahlar	500	Ön hazırlama	150
Yağlama bölümleri	150	Kontrol ve seçme	200
Yağlama yerleri	250	Sigara makineleri	400

	LUX		LUX
KONSERVE ENDÜSTRİSİ		Trafığı önemli olmayan ticari cadde	7.5
Yiyecek ayıklama	200	Trafığı olan konutlu cadde	7.5
Yıkama temizleme	200	Trafığı olmayan konutlu cadde	5
Renklerin ayrılması	300	Önemli bir çıkmaz sokak	15
Gerekli parçaları ayırma	300	Dağıtım garları	10
Kutulara koyma mek.	300	Bağımlı İşletmeler	
Kutulara koyma elle	200	Taşıma bölgeleri	20
Boş kutuların kontrolü	100	Stoklama(doldurma ve boşaltım)	20
Kutu kaynağı	300	Gözetleme aydınlatması	5
Paketleme-ambalaj	150	Girişler	50
SÜT ENDÜSTRİSİ		Yükleme platformları	50
Sterilizasyon odası	150	Trafığı olan ticari cadde	10
Pastorizasyon odası	150		
Kalıpların yıkanması	150		
Soğuk odalar	150		
Krema ayrılması	150		
Şişelerin seçimi	200		
Şişe yıkama makinası	400		
Doldurma salonu	125		
Laboratuvar	400		
ŞEKER ENDÜSTRİSİ			
Kesme karıştırma	200		
Temizleme.arıtma	400		
Renk kontrolü	750		
Depolama	50		
ELEKTRİK SANTRALİ			
Yanma hav. haz. Tesis	50		
Akümülatör dairesi	100		
Kazan bakım atölyesi	100		
Kazanların ön kısmı	50		
Kazana yakıt yük.	100		
DIŞ AYDINLATMA			
Genel halka açık aydınlatma			
Yerleşim bölgesinin dışı.ana trafik arteri	20		
Belediyeler arası anayol	15		
Belediyeler arası yol	10		
Yerleşim Bölgesinin İçi	30		
Kent içindeki hızlı dolaşım yolları	20		
Yakın yollar	20		
Tüneller(gün boyunca aydınlatma)	100		
Giriş aydınlatması	1000		
Gece aydınlatması	30		
Sanayi bölgesindeki liman ya da sokaklar	10		
Kıyı tevsiiye havuzu ya da köprü	10		

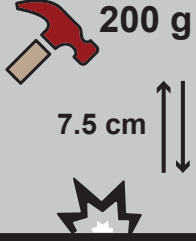

0.15 joule Darbe
İK 01

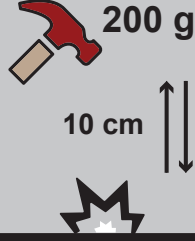

0.20 joule Darbe
İK 02



0.35 joule Darbe
İK 03



0.5 joule Darbe
İK 04



0.7 joule Darbe
İK 05

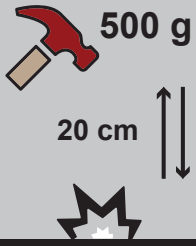

1 joule Darbe
İK 06



2 joule Darbe
İK 07

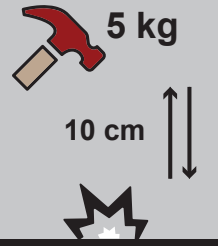

5 joule Darbe
İK 08

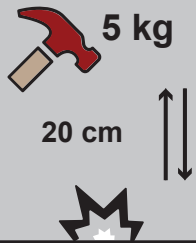

10 joule Darbe
İK 09



20 joule Darbe
İK 10

İK Koruma Sınıfı Nedir?

İK koruma sınıfı, elektrikli ve elektronik cihazların dış etkilere karşı dayanıklılığını belirten uluslararası bir standarttır. Bu sınıflandırma, özellikle mekanik darbelere karşı koruma seviyesini tanımlamak için kullanılır ve IEC 62262 standardına dayanır. İK derecelendirmesi, genellikle endüstriyel ekipmanlar, dış ortamda kullanılan cihazlar, güvenlik kameraları, aydınlatma armatürleri ve benzeri ürünlerin fiziksel dayanıklılığını belirlemek için önemli bir kriterdir.

İK Derecelendirme Standardı

İK koruma sınıfları, cihazın darbelere karşı gösterdiği direnci ifade eder ve genellikle "İK" harfleri ile başlayıp iki rakamdan oluşan bir değer ile belirtilir (örneğin, İK08, İK10). IEC 62262 standardına göre, her bir İK derecesi belirli bir darbe enerjisi seviyesi ile test edilir. Bu testler sırasında farklı büyüklükteki çekiç veya benzeri darbeli test cihazları kullanılarak ürünlerin dayanıklılığı ölçülür.

İK Derecesi Nasıl Belirlenir?

İK derecelendirme testi, belirli yüksekliklerden farklı ağırlıklarda düşen nesnelere yapılır. Test sırasında:

- Ürün, belirlenen bir yükseklikten serbest bırakılan bir çekiçle darbeye maruz bırakılır.
- Darbe noktaları önceden belirlenir ve test sırasında farklı açılardan uygulanır.
- Test sonucunda ürünün hasar durumu incelenir ve belirli bir İK derecesi atanır.

İK Koruma Sınıfının Önemi

İK koruma sınıfı, özellikle dış mekanlarda veya zorlu endüstriyel ortamlarda kullanılan cihazlar için büyük önem taşır. Yüksek İK derecesine sahip ürünler, darbelere karşı daha dayanıklı olup uzun ömürlü bir kullanım sağlar. Özellikle güvenlik kameraları, dış mekan aydınlatmaları ve kamuya açık alanlardaki ekipmanlarda İK dereceleri büyük bir belirleyici faktördür.

İK Derecesi ile IP Koruma Sınıfı Arasındaki Fark

İK koruma sınıfı, fiziksel darbelere karşı koruma seviyesini ifade ederken, IP (Ingress Protection) koruma sınıfı, suya ve toza karşı koruma seviyesini belirtir. Örneğin, bir cihaz İK10 ve IP67 derecesine sahip olabilir. Bu, cihazın hem güçlü darbelere hem de su ve toz girişine karşı dayanıklı olduğu anlamına gelir.

What is IK Protection Class?

The IK protection class is an international standard that determines the durability of electrical and electronic devices against external influences. This classification is specifically used to define the level of protection against mechanical impacts and is based on the IEC 62262 standard. IK rating is an important criterion for determining the physical durability of industrial equipment, outdoor devices, security cameras, lighting fixtures, and similar products.

IK Rating Standard

IK protection classes indicate the resistance of a device to impacts and are usually denoted by the letters "IK" followed by a two-digit value (e.g., IK08, IK10). According to the IEC 62262 standard, each IK rating is tested at a specific impact energy level. During these tests, various sizes of hammers or similar impact test devices are used to measure the durability of the products.

How is the IK Rating Determined?

The IK rating test is conducted by dropping objects of different weights from specific heights. During the test:

- The product is subjected to impact by a hammer released from a predetermined height.
- Impact points are determined in advance and applied from different angles during the test.
- After the test, the product's damage status is examined, and a specific IK rating is assigned.

Importance of the IK Protection Class

The IK protection class is crucial for devices used in outdoor environments or harsh industrial conditions. Products with a high IK rating are more resistant to impacts and offer a longer lifespan. IK ratings are a significant factor, especially in security cameras, outdoor lighting, and public area equipment.

Difference Between IK Rating and IP Protection Class

While the IK protection class defines the level of protection against physical impacts, the IP (Ingress Protection) protection class indicates the level of protection against water and dust. For example, a device with an IK10 and IP67 rating is resistant to both strong impacts and water and dust ingress.



TÜRK PATENT
TÜRK PATENT VE MARKA KURUMU
MARKA TESCİL BELGESİ
No: 2025 015696 - Ticaret - Hizmet



Marka Sahibi
BORLED AYDINLATMA ELEKTRİK İNŞAAT SANAYİ VE TİCARET LİMİTED ŞİRKETİ

Mal / Hizmet Sınıfları
06, 07, 09, 11, 35

Bu marka, 6769 sayılı Sınai Mülkiyet Kanunu kapsamında,
05.02.2025 tarihinden itibaren 10 yıl süreyle korunmak üzere,
30.11.2025 tarihinde tescil edilmiştir.

Prof. Dr. M. Zeki DURAK
Başkan



İSTANBUL OFİS

Worldwide Business Center

Barbaros Mah. Mor Sümbül Sok.

No:9 Kat: 8 PK: 34746 Batı Ataşehir / İstanbul

info@borsan.com.tr / export@borsan.com.tr

FABRİKA

Kerimbey Mah. OSB Vali M. Erdoğan Cebeci Bulvarı

No: 54 Tekkeköy / Samsun, 55300

T: +90 (362) 266 99 14 / F: +90 (362) 266 99 89

info@borled.com.tr