

**AYDINLATMA  
ÜRÜNLERİ KATALOĞU**

**LIGHTING  
PRODUCTS CATALOG**



## Borled By Borsan Hakkında

2017 yılı itibari ile LED'li aydınlatma ürün imalatında faaliyete geçen Borled Aydınlatma, modern LED ve 40 yılı aşkın Borsan tecrübesi sayesinde güçlü bir büyüme sergilemiştir. Borled, 2025 itibari ile faaliyetlerini Borled by Borsan kurumsal markası ve Borled Aydınlatma tüzel kişiliği ile, yine Borsan Grup bünyesinde sürdürmektedir.

Gerek Türkiye pazarında gerekse başta Ortadoğu, Afrika, Türki Cumhuriyetler ve Avrupa olmak üzere ihracat pazarlarında yüksek kalite algısına ve marka gücüne sahip olan Borled by Borsan, belirlemiş olduğu hedeflere bu yeni yapıyla ve Borsan markasının birçok ülkede sahip olduğu saygın konumun desteğiyle yürüyüşünü sürdürmektedir.

Borled by Borsan yine 2025 yılı başında, özellikle Orta Doğu, Afrika ve Asya pazarlarına aktif ihracat gerçekleştiren, Ar-Ge, Özel Tasarım ve Ürün Montaj kabiliyetleri ile bilinen; elektrik, elektronik ve LED konusunda çok yüksek know-how birikimine sahip, Çin merkezli Lixin Lighting firmasıyla ortaklık sözleşmesine imza atmıştır.

Borled by Borsan bu ortaklıkla kaliteden taviz vermeden, verimliliği artırarak rekabetçi fiyat yapısını ulaştırırken, aynı zamanda ürün çeşitliliğini de artırmayı hedeflemektedir. Aynı zamanda Lixin Lighting ile ortaklaşa olarak, 2025-2028 arası 3 yıllık dönemde teknoloji transferi, Ar-Ge ve kapasite artırımı odaklı olarak 25 milyon dolar düzeyinde yatırım planlanmış durumdadır. Borled by Borsan cirosunun, bu yatırımlarla 3 yıl içerisinde 3 katın üzerinde bir büyüme performansıyla 35 milyon dolar ciroya ulaşması hedeflenmektedir.

İlk aşamada makine ve işletme sermayesi odaklı olarak, 2025 yılı içerisinde yüksek fikri mülkiyet değeri özelliğine sahip etanj armatür ve hali hazırda Türkiye'de üretimi yapılamayan NEON üretimi için makine ve kalıp yatırımları gerçekleştirecek ve yatırımlar, NEON aydınlatma üretimi, dizgi ve metal baskı, boya makine gibi alanlarda devam edecektir. Yatırımlar paralelinde ciroda 3 katın üzerinde büyümenin yanı sıra, özellikle kadın çalışan ağırlıklı 100 kişilik yeni istihdam oluşturulması da hedeflenmektedir. Borsan Grubun genel prensibi olan kadın istihdamında pozitif ayrımcılık kapsamında kadın çalışanlara öncelik vermeye devam edilecektir.

Çin, LED ve Elektronik üretiminde dünyanın inovasyon merkezi durumundadır ve LED Aydınlatma teknolojilerinin dünya genelindeki gelişimine ve sektörün küresel üretimine Çin merkezli firmalar yön vermektedir. Ancak, Çin'de geliştirilen yeni tasarımlı ve teknoloji LED aydınlatma ürünlerinin, özellikle Türkiye ve çevresinde pazara sunulması belirli bir faz farkı ile gerçekleşmektedir. Lixin Lighting iş birliği, en son nesil tasarım ve ürünlerin, Türkiye ve ihracat pazarlarına daha hızlı ve 'Made in Türkiye' markasının gücüyle ile sunulmasıyla rekabet avantajı sağlayacaktır. Borled Aydınlatma'nın özellikle ihracat pazarlarındaki büyümesi, böylece 'Made in Türkiye' algısına da katkı yapacak niteliktedir.

Samsun Organize Sanayi Bölgesi içerisinde bulunan, 15.000m<sup>2</sup>'lik kapalı alanda üretim ve ürün tasarımları yapan Borled Aydınlatma Fabrikası, plastik üretim hatlarında 880 bin, saç metal üretim hatlarında 750 bin, montaj ve paketleme hatlarında ise 334 bin adet aylık kapasiteye sahiptir. Borled by Borsan üretim kimliği, yüksek teknolojiye sahip üretim ekipmanları, laboratuvarı ve kalite yönetimini destekleyen test alanları, müşteri odaklı yurtiçi/ yurtdışı satış ve pazarlama departmanları, paydaşlarının ihtiyaç duyacağı tüm gereksinimleri karşılamaktadır.

Borled by Borsan ürün gruplarında, dünyada süregelen teknolojik gelişmeler ışığında dayanıklılık, verimlilik ve tasarruf değerleri en üst düzeye çıkmaktadır. Toplam kalite yönetimi anlayışı, müşteri memnuniyetini her zaman ön planda tutmaktadır.

Borled by Borsan TSE, CE, RoHS gibi ulusal kalite belgeleri ve uluslararası deklarasyonlarına sahip ürünleri ile konut, okul, hastane, ofis, AVM, endüstriyel tesisler ve kamu kuruluşları gibi alanlarda hizmet vermektedir. Bünyesinde bulunan test laboratuvarları, makine parkuru ve uzman kadrosu ile daha fazla alana hizmet vermek için çalışmalarını sürdürmektedir. Borsan faaliyet gösterdiği tüm sektörlerde bir dünya markası vizyonuna ulaşabilmek için Ar-Ge faaliyetlerine sürekli yatırım yapmaktadır.

Sanayi ve Teknoloji Bakanlığı tarafından 2018 yılında tescil edilen Borsan Ar-Ge Merkezi 350m<sup>2</sup> alanda kurulu Karadeniz'in en büyük Aydınlatma Laboratuvarının yanı sıra, Yangın test Laboratuvarı, Metal ve Polimer Laboratuvarı gibi bölümlerde özel ekipman, cihazlar ve test programlarının kullanılmakta, yirminin üzerinde Ar-Ge mühendisi ve araştırmacı personel görev yapmaktadır.

Borled Aydınlatma Laboratuvarı, her koşulda üstün niteliklere sahip aydınlatma ekipmanlarının tasarımına olanak sağlamaktadır. Uzman ekibi ve modern teknolojisi sayesinde, ışığın hem matematiksel hem de insan fizyolojisini olumlu etkileyecek özelliklerini belirleyerek, tasarımları ve kalitesini her zaman en üst seviyede sunmaktadır. Borled Aydınlatma Laboratuvarı, iç ve dış mekân aydınlatması ile ilgili TS EN 60598-1 (Aydınlatma Armatürleri Güvenlik Gereksinimleri) standardına uygun olarak ölçümler gerçekleştirmektedir. Ürünlerin güvenlik testleri, armatür ve lambaların fotometrik değerleri, elektriksel, kimyasal ve fiziksel özelliklerinin ölçümleri yapılmakta olup, cihazlarda yapılan periyodik ara kontrol ve kalibrasyonlar sayesinde ürün kalitesi en üst seviyede tutulmaktadır.

Borsan bünyesinde Borled by Borsan, yenilikçilik ruhu ile sürekli yeni ürünler geliştiren, kalitesiyle fark yaratan, geleceğe gururla taşınan Türkiye'nin lider markalardan biri olmaya daima devam edecektir.

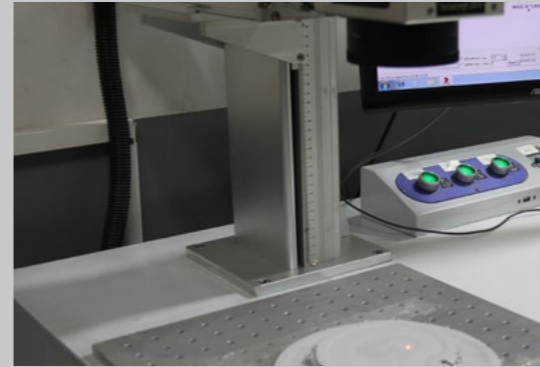
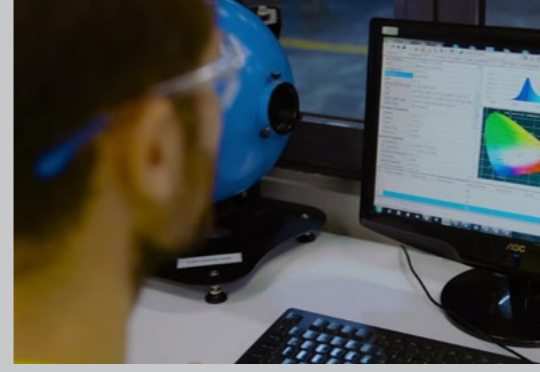

## About Borled By Borsan

Borled Lighting has been actively engaged in the production of LED lighting products since As of 2017, and demonstrated strong growth with its modern LED technology and Borsan's over 40 years of experience. As of 2025, Borled continues its operations under the corporate brand Borled by Borsan and the legal entity Borled Lighting, remaining within the structure of the Borsan Group.

Borled by Borsan enjoys a strong brand perception and reputation for high quality, both in the Turkish market and in export markets, particularly in the Middle East, Africa, Turkic Republics, and Europe. With this new structure and the strong global position of the Borsan brand, the company continues its journey toward achieving its long term objectives.

At the beginning of 2025, Borled by Borsan signed a partnership agreement with Lixin Lighting, a China-based company known for its extensive know-how in electricity, electronics, and LED technologies. Lixin Lighting is actively involved in exports to the Middle East, Africa, and Asia and is recognized for its R&D, custom design, and product assembly capabilities.

Through this partnership, Borled by Borsan aims to enhance efficiency, and expand its product range, while maintaining high quality and achieving a competitive pricing structure. A \$25 million investment is planned for the 2025-2028 period, focusing on technology transfer, R&D, and capacity expansion. With these investments, Borled by Borsan aims to triple its revenue within three years, reaching an annual turnover of \$35 million.

In the initial phase, investments will be made in machines and molds for the production of watertight luminaires and NEON lighting, which are currently not manufactured in Turkey. Further investments will be directed toward NEON lighting production, assembly, metal pressing, and painting machines. Alongside revenue growth, the company plans to create 100 new jobs, with a particular focus on employing women in line with Borsan Group's policy of gender-inclusive hiring.

China serves as the global innovation hub for LED and electronics manufacturing, playing a pivotal role in the development of LED lighting technologies worldwide. However, newly developed LED lighting products in China often enter markets such as Turkey with a certain time lag. The partnership with Lixin Lighting will enable Borled by Borsan to introduce the latest-generation designs and products to Turkey and export markets more swiftly, leveraging the strength of the Made in Türkiye brand for a competitive advantage. This strategy will not only drive Borled Lighting's export growth but also contribute to the Made in Türkiye brand perception on an international scale.

Located in the Samsun Organized Industrial Zone, Borled Lighting operates a 15,000m<sup>2</sup> enclosed production and design facility. The factory boasts an impressive monthly production capacity of 880,000 units in plastic production lines, 750,000 units in sheet metal production lines, and 334,000 units in assembly and packaging lines.

Borled by Borsan's manufacturing identity is reinforced by state-of-the-art production equipment, laboratories, and testing areas that support its quality management system. With a strong focus on customer satisfaction, the company's domestic and international sales and marketing teams ensure that all stakeholder requirements are met.

Borled by Borsan's product lines are designed with the latest technological advancements to maximize durability, efficiency, and energy savings. The company adheres to Total Quality Management principles, always prioritizing customer satisfaction.

Certified with TSE, CE, RoHS, and other national and international quality standards, Borled by Borsan serves a variety of industries, including residential, educational, healthcare, office, shopping mall, industrial, and public sector applications. The company continues to expand its services through its in-house testing laboratories, advanced machinery, and expert team.

Borsan Group continually invests in R&D to establish itself as a global brand across all industries in which it operates. Registered by the Ministry of Industry and Technology in 2018, the Borsan R&D Center is home to the largest lighting laboratory in the Black Sea region (350m<sup>2</sup>). It also features a Fire Testing Laboratory, Metal and Polymer Laboratory, and other specialized research facilities. The center employs over 20 R&D engineers and researchers utilizing advanced equipment and testing programs.

The Borled Lighting Laboratory is dedicated to designing high-performance lighting equipment under all conditions. With its expert team and cutting-edge technology, it ensures that lighting designs optimize both mathematical precision and human physiological well-being. The laboratory conducts measurements in compliance with the TS EN 60598-1 (Lighting Fixtures Safety Requirements) standard. It performs safety tests, photometric evaluations, and electrical, chemical, and physical property analyses on products. Periodic inspections and calibrations of devices ensure that product quality remains at the highest level.

With its spirit of innovation, Borled by Borsan continues to develop new products that stand out for their quality and technological advancements. As one of Turkey's leading brands, it remains committed to shaping the future with pride.

# SLİM LED ARMATÜR SLİM LED ARMATURE

## Teknik Özellikler Technical Specifications

Gövde : Alüminyum  
Body : Aluminium

Gövde Renkleri : Beyaz  
Body Colors : White

Difüzör : PMMA  
Diffuser : PMMA

Renksel Geri Verim : 80  
Color Rendering Index : 80

IP Derecesi : IP20  
IP Rating : IP20

IK Derecesi : IK03  
IK Rating : IK03

Elektriksel Koruma : Sınıf II  
Electrical Protection : Class II

Çalışma Sıcaklığı : -20°C / 45°C  
Operating Temp. Range : -20°C / 45°C

SİYAH RENK GÖVDE OPSİYONU VARDIR  
Fiyat Sorunuz.



### SLİM LED ARMATÜR

Kurulumu kolay, maksimum performansa sahip uzun ömürlü, ekonomik ve güvenilir bir sıra altı tavan armatürüdür. Tüm iç mekanlarda; evlerde, ofislerde, hastane, otel, avm, mağazalar için idealdir.

### SLİM LED ARMATURE

It is an easy to install, long-lasting, economical and reliable flush-mounted ceiling luminaire with maximum performance. In all interiors; Ideal for homes, offices, hospitals, hotels, shopping malls, stores.

# YUVARLAK SLİM LED ARMATÜR ROUND SLİM LED ARMATURE

Enerji Verimliliği Sınıfı Energy Efficiency Class	Ürün Kodu Product Code	Güç (W) Power	Renk Sıcaklığı (K) Color Temperature	Işık Akısı (Lm) Luminous Flux	Boyutlar (ØxH) mm Dimensions	Kesme Ebatı (Ø) mm Cutting Size	Koli Adeti Quantity in Carton	Fiyat Price
A+G	BL-S1-2001	3W	3000 K	165	82 × 14	73	48	\$3,40
A+G	BL-S1-2002	3W	4000 K	165	82 × 14	73	48	\$3,40
A+G	BL-S1-2003	3W	6500 K	165	82 × 14	73	48	\$3,40
A+G	BL-S1-2004	6W	3000 K	390	118 × 14	110	48	\$4,90
A+G	BL-S1-2005	6W	4000 K	390	118 × 14	110	48	\$4,90
A+G	BL-S1-2006	6W	6500 K	390	118 × 14	110	48	\$4,90
A+G	BL-S1-2007	9W	3000 K	630	145 × 14	135	24	\$6,20
A+G	BL-S1-2008	9W	4000 K	630	145 × 14	135	24	\$6,20
A+G	BL-S1-2009	9W	6500 K	630	145 × 14	135	24	\$6,20
A+G	BL-S1-2010	12W	3000 K	960	168 × 14	155	24	\$6,70
A+G	BL-S1-2011	12W	4000 K	960	168 × 14	155	24	\$6,70
A+G	BL-S1-2012	12W	6500 K	960	168 × 14	155	24	\$6,70
A+G	BL-S1-2013	15W	3000 K	1200	190 × 14	175	24	\$7,90
A+G	BL-S1-2014	15W	4000 K	1200	190 × 14	175	24	\$7,90
A+G	BL-S1-2015	15W	6500 K	1200	190 × 14	175	24	\$7,90
A+G	BL-S1-2016	18W	3000 K	1440	225 × 15	210	24	\$8,40
A+G	BL-S1-2017	18W	4000 K	1440	225 × 15	210	24	\$8,40
A+G	BL-S1-2018	18W	6500 K	1440	225 × 15	210	24	\$8,40
A+G	BL-S1-2019	24W	3000 K	2040	300 × 15	285	24	\$13,70
A+G	BL-S1-2020	24W	4000 K	2040	300 × 15	285	24	\$13,70
A+G	BL-S1-2021	24W	6500 K	2040	300 × 15	285	24	\$13,70

# KARE SLİM LED ARMATÜR SQUARE SLİM LED ARMATURE

Enerji Verimliliği Sınıfı Energy Efficiency Class	Ürün Kodu Product Code	Güç (W) Power	Renk Sıcaklığı (K) Color Temperature	Işık Akısı (Lm) Luminous Flux	Boyutlar (WxLxH) mm Dimensions	Kesme Ebatı(mm) Cutting Size	Koli Adeti Quantity in Carton	Fiyat Price
A+G	BL-S1-2022	18W	3000 K	1350	225 × 225 × 15	210 × 210	24	\$11,00
A+G	BL-S1-2023	18W	4000 K	1350	225 × 225 × 15	210 × 210	24	\$11,00
A+G	BL-S1-2024	18W	6500 K	1350	225 × 225 × 15	210 × 210	24	\$11,00
A+G	BL-S1-2025	24W	3000 K	1920	300 × 300 × 15	280 × 280	24	\$13,50
A+G	BL-S1-2026	24W	4000 K	1920	300 × 300 × 15	280 × 280	24	\$13,50
A+G	BL-S1-2027	24W	6500 K	1920	300 × 300 × 15	280 × 280	24	\$13,50

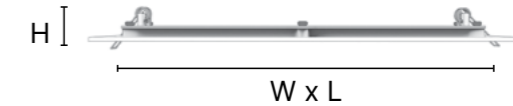
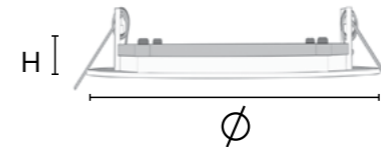

Teknik veri / Datasheet

www.borled.com.tr

# SIVA ÜSTÜ LED PANEL ARMATÜR

## SURFACE MOUNTED LED PANEL

### Teknik Özellikler

#### Technical Specifications

Gövde : Alüminyum  
Body : Aluminium

Gövde Renkleri : Beyaz  
Body Colors : White

Çerçeve : DKP Sac  
Frame : DKP Metal Sheet

Difüzör : PMMA  
Diffuser : PMMA

Renksel Geri Verim : 80  
Color Rendering Index : 80

IP Derecesi : IP20  
IP Rating : IP20

IK Derecesi : IK03  
IK Rating : IK03

Elektriksel Koruma : Sınıf II  
Electrical Protection : Class II

Çalışma Sıcaklığı : -20°C / 45°C  
Operating Temp. Range : -20°C / 45°C

SİYAH RENK GÖVDE OPSİYONU VARDIR  
Fiyat Sorunuz.

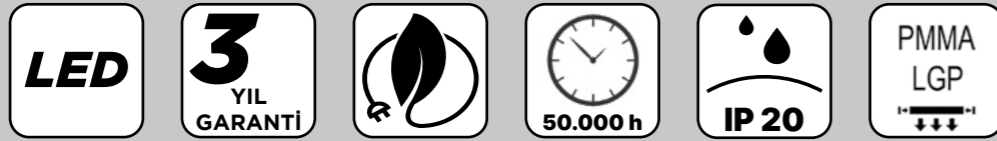

### SIVA ÜSTÜ LED PANEL ARMATÜR

Önemli ölçüde enerji ve bakım tasarrufu sağlayan yüksek performanslı düz panel armatürdür. Şık minimalist tasarıma sahip ince led panellerimiz, azaltılmış enerji tüketimi ile geleneksel floresan tipi aydınlatma çözümlerine eşdeğerdir. Uygun maliyetli, ince bir aydınlatma hattı gerektiren ofis, sağlık, eğitim, otel, restoran, alışveriş merkezi ve ticari alanlar gibi geniş bir uygulama yelpazesi için uygundur.

### SURFACE MOUNTED LED PANEL

It is a high-performance flat panel luminaire that provides significant energy and maintenance savings. Our slim led panels with stylish minimalist design are equivalent to traditional fluorescent type lighting solutions with reduced energy consumption. It is suitable for a wide range of applications such as office, health, education, hotel, restaurant, shopping mall and commercial areas that require a cost-effective, thin line of lighting.

# SIVA ÜSTÜ YUVARLAK LED PANEL

## SURFACE MOUNTED ROUND LED PANEL

Enerji Verimliliği Sınıfı Energy Efficiency Class	Ürün Kodu Product Code	Güç (W) Power	Renk Sıcaklığı (K) Color Temperature	Işık Akısı (Lm) Luminous Flux	Boyutlar (ØxH) mm Dimensions	Koli Adeti Quantity in Carton	Fiyat Price
A+G	BL-S2-2013	15W	3000 K	1200	162 × 25	20	\$7,60
A+G	BL-S2-2014	15W	4000 K	1200	162 × 25	20	\$7,60
A+G	BL-S2-2015	15W	6500 K	1200	162 × 25	20	\$7,60
A+G	BL-S2-2016	18W	3000 K	1440	210 × 25	20	\$10,00
A+G	BL-S2-2017	18W	4000 K	1440	210 × 25	20	\$10,00
A+G	BL-S2-2018	18W	6500 K	1440	210 × 25	20	\$10,00
A+G	BL-S2-2019	24W	3000 K	2040	285 × 25	20	\$14,00
A+G	BL-S2-2020	24W	4000 K	2040	285 × 25	20	\$14,00
A+G	BL-S2-2021	24W	6500 K	2040	285 × 25	20	\$14,00

# SIVA ÜSTÜ KARE LED PANEL

## SURFACE MOUNTED SQUARE LED PANEL

Enerji Verimliliği Sınıfı Energy Efficiency Class	Ürün Kodu Product Code	Güç (W) Power	Renk Sıcaklığı (K) Color Temperature	Işık Akısı (Lm) Luminous Flux	Boyutlar (WxLxH) mm Dimensions	Koli Adeti Quantity in Carton	Fiyat Price
A+G	BL-S2-2022	15W	3000 K	1200	162 × 162 × 25	20	\$8,00
A+G	BL-S2-2023	15W	4000 K	1200	162 × 162 × 25	20	\$8,00
A+G	BL-S2-2024	15W	6500 K	1200	162 × 162 × 25	20	\$8,00
A+G	BL-S2-2025	18W	3000 K	1440	210 × 210 × 25	20	\$10,60
A+G	BL-S2-2026	18W	4000 K	1440	210 × 210 × 25	20	\$10,60
A+G	BL-S2-2027	18W	6500 K	1440	210 × 210 × 25	20	\$10,60
A+G	BL-S2-2028	24W	3000 K	2040	285 × 285 × 25	20	\$15,00
A+G	BL-S2-2029	24W	4000 K	2040	285 × 285 × 25	20	\$15,00
A+G	BL-S2-2030	24W	6500 K	2040	285 × 285 × 25	20	\$15,00

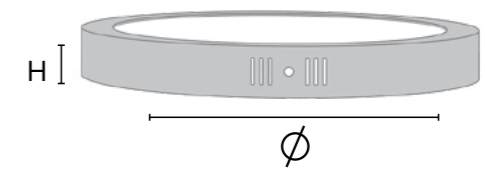
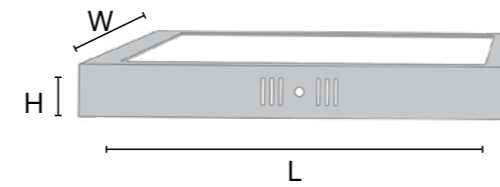

Teknik veri / Datasheet

www.borled.com.tr

# BACKLIGHT DOWNLIGHT ARMATÜR

## BACKLIGHT DOWNLIGHT ARMATURE

### Teknik Özellikler

#### Technical Specifications

Gövde : Alüminyum  
Body : Aluminium

Gövde Renkleri : Beyaz  
Body Colors : White

Difüzör : PMMA  
Diffuser : PMMA

Renksel Geri Verim : 80  
Color Rendering Index : 80

IP Derecesi : IP40  
IP Rating : IP40

IK Derecesi : IK03  
IK Rating : IK03

Elektriksel Koruma : Sınıf II  
Electrical Protection : Class II

Çalışma Sıcaklığı : -20°C / 45°C  
Operating Temp. Range : -20°C / 45°C



### BACKLIGHT DOWNLIGHT ARMATÜR

Özel alüminyum alaşımli kasası mükemmel ısı dağılımı sağlar. Yeni nesil devre tasarımı akım sürücüsü ile yüksek ışık gücüne, verimli enerji tasarrufu ve maksimum performansa sahip bir sıva altı tavan armatürüdür. Kolay kurulum, uzun ömürlü, ekonomik ve güvenilir bir kullanım sunar.

Tüm iç mekanlarda; evlerde, ofislerde, hastane, otel, avm, mağaza ve özellikle vitrinler için idealdir.

### BACKLIGHT DOWNLIGHT ARMATURE

Its special Aluminium alloy casing provides excellent heat dissipation. It is a flush-mounted ceiling luminaire with high light power, efficient energy saving and maximum performance with its new generation circuit design current driver. It offers easy installation, long-lasting, economical and reliable use.

In all interiors; It is ideal for homes, offices, hospitals, hotels, shopping malls, stores and especially showcases.

# YUVARLAK BACKLIGHT DOWNLIGHT ARMATÜR

## ROUND BACKLIGHT DOWNLIGHT ARMATURE

TURQUALITY®

Enerji Verimliliği Sınıfı Energy Efficiency Class	Ürün Kodu Product Code	Güç (W) Power	Renk Sıcaklığı (K) Color Temperature	Işık Akısı (Lm) Luminous Flux	Boyutlar (ØxH) mm Dimensions	Kesme Ebatı (Ø) mm Cutting Size	Koli Adeti Quantity in Carton	Fiyat Price
A T G	BL-BD-0001	10W	3000 K	1110	94 × 42	73	50	\$56,30
A T G	BL-BD-0002	10W	4000 K	1110	94 × 42	73	50	\$56,30
A T G	BL-BD-0003	10W	6500 K	1110	94 × 42	73	50	\$56,30
A T G	BL-BD-0004	15W	3000 K	1575	127 × 46	97	50	\$65,30
A T G	BL-BD-0005	15W	4000 K	1575	127 × 46	97	50	\$65,30
A T G	BL-BD-0006	15W	6500 K	1575	127 × 46	97	50	\$65,30
A T G	BL-BD-0007	20W	3000 K	2220	164 × 58	140	50	\$72,70
A T G	BL-BD-0008	20W	4000 K	2220	164 × 58	140	50	\$72,70
A T G	BL-BD-0009	20W	6500 K	2220	164 × 58	140	50	\$72,70
A T G	BL-BD-0010	30W	3000 K	3330	222 × 54,5	177	50	\$83,60
A T G	BL-BD-0011	30W	4000 K	3330	222 × 54,5	177	50	\$83,60
A T G	BL-BD-0012	30W	6500 K	3330	222 × 54,5	177	50	\$83,60

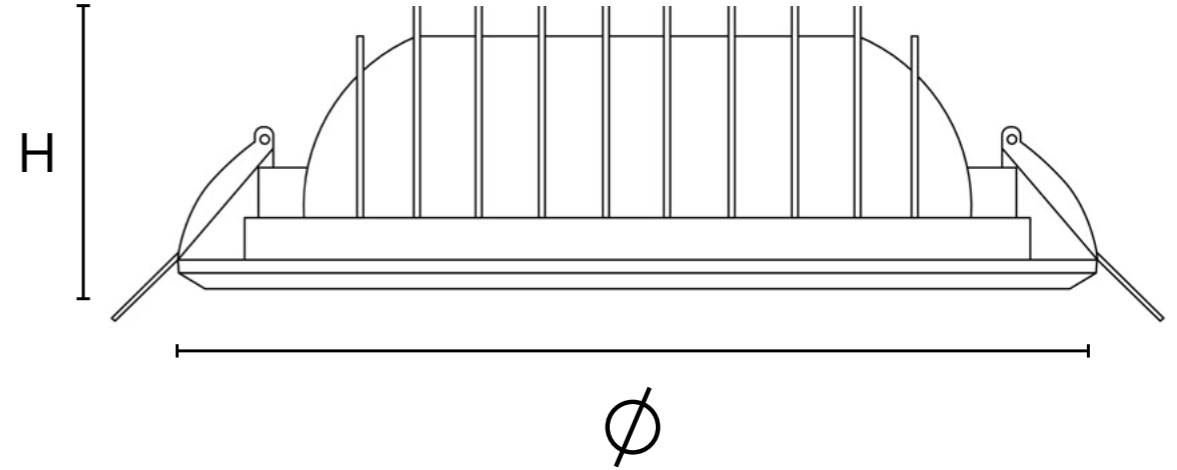

# BETA BACKLIGHT DOWNLIGHT

## BETA BACKLIGHT DOWNLIGHT

### Teknik Özellikler

#### Technical Specifications

Gövde : Alüminyum  
Body : Aluminium

Gövde Renkleri : Beyaz  
Body Colors : White

Difüzör : PMMA  
Diffuser : PMMA

Renksel Geri Verim : 80  
Color Rendering Index : 80

IP Derecesi : IP40  
IP Rating : IP40

IK Derecesi : IK03  
IK Rating : IK03

Elektriksel Koruma : Sınıf II  
Electrical Protection : Class II

Çalışma Sıcaklığı : -20°C / 45°C  
Operating Temp. Range : -20°C / 45°C



### BETA BACKLIGHT DOWNLIGHT

Özel alüminyum alaşımlı kasası mükemmel ısı dağılımı sağlar. Yeni nesil devre tasarımlı akım sürücüsü ile yüksek ışık gücüne, verimli enerji tasarrufu ve maksimum performansla sahip bir sıva altı tavan armatürüdür. Kolay kurulum, uzun ömürlü, ekonomik ve güvenilir bir kullanım sunar.

Tüm iç mekanlarda; evlerde, ofislerde, hastane, otel, avm, mağaza ve özellikle vitrinler için idealdir.

### BETA BACKLIGHT DOWNLIGHT

Its special Aluminium alloy casing provides excellent heat dissipation. It is a flush-mounted ceiling luminaire with high light power, efficient energy saving and maximum performance with its new generation circuit design current driver. It offers easy installation, long-lasting, economical and reliable use.

In all interiors; It is ideal for homes, offices, hospitals, hotels, shopping malls, stores and especially showcases.

### BETA BACKLIGHT DOWNLIGHT ARMATÜR

#### BETA BACKLIGHT DOWNLIGHT ARMATURE

Enerji Verimliliği Sınıfı Energy Efficiency Class	Ürün Kodu Product Code	Güç (W) Power	Renk Sıcaklığı (K) Color Temperature	Işık Akısı (Lm) Luminous Flux	Boyutlar (ØxH) mm Dimensions	Kesme Ebatı (Ø) mm Cutting Size	Koli Adeti Quantity in Carton	Fiyat Price	
A+G	F	BL-BD-2001	8W	3000 K	800	97 × 55	85	36	\$30,70
A+G	F	BL-BD-2002	8W	4000 K	800	97 × 55	85	36	\$30,70
A+G	F	BL-BD-2003	8W	6500 K	800	97 × 55	85	36	\$30,70
A+G	F	BL-BD-2004	10W	3000 K	1000	117 × 48	105	36	\$35,00
A+G	F	BL-BD-2005	10W	4000 K	1000	117 × 48	105	36	\$35,00
A+G	F	BL-BD-2006	10W	6500 K	1000	117 × 48	105	36	\$35,00
A+G	F	BL-BD-2007	15W	3000 K	1500	147 × 54	130	36	\$41,60
A+G	F	BL-BD-2008	15W	4000 K	1500	147 × 54	130	36	\$41,60
A+G	F	BL-BD-2009	15W	6500 K	1500	147 × 54	130	36	\$41,60
A+G	F	BL-BD-2010	18W	3000 K	1800	175 × 58	160	18	\$46,00
A+G	F	BL-BD-2011	18W	4000 K	1800	175 × 58	160	18	\$46,00
A+G	F	BL-BD-2012	18W	6500 K	1800	175 × 58	160	18	\$46,00
A+G	F	BL-BD-2013	25W	3000 K	2500	192 × 55	175	16	\$56,90
A+G	F	BL-BD-2014	25W	4000 K	2500	192 × 55	175	16	\$56,90
A+G	F	BL-BD-2015	25W	6500 K	2500	192 × 55	175	16	\$56,90
A+G	F	BL-BD-2016	30W	3000 K	3000	227 × 58	210	16	\$61,30
A+G	F	BL-BD-2017	30W	4000 K	3000	227 × 58	210	16	\$61,30
A+G	F	BL-BD-2018	30W	6500 K	3000	227 × 58	210	16	\$61,30

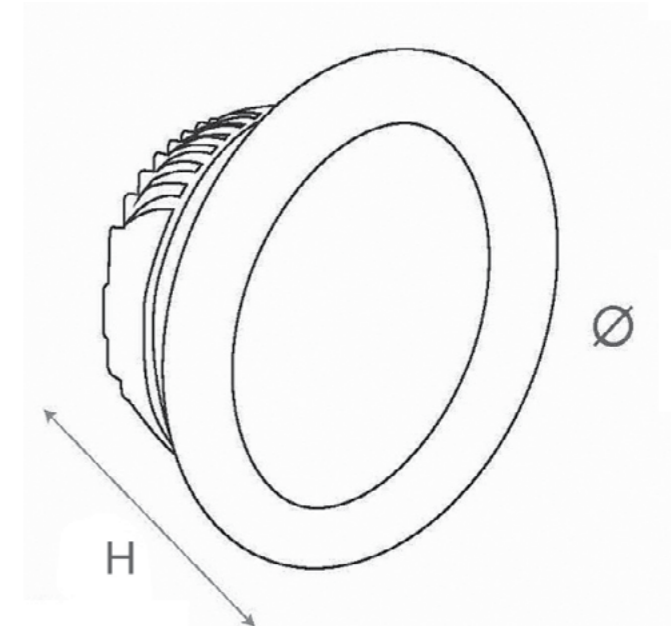

Teknik veri / Datasheet

www.borled.com.tr

# COB LED ARMATÜR COB LED ARMATURE

## Teknik Özellikler Technical Specifications

Gövde : Alüminyum  
Body : Aluminium

IP Derecesi : IP20  
IP Rating : IP20

Güç Faktörü : 0.9  
Power Factor : 0.9

Renksel Geri Verim : 80  
Color Rendering Index : 80



### COB LED ARMATÜR

Yüksek kalitede Led çipine sahiptir. Renk değişimlerine ve sararmaya dayanıklı, alüminyum enjeksiyonlu, elektrostatik toz boyalı ve uzun ömürlü homojen ışık veren optik ekranlı bir aydınlatma armatürüdür. Ayrıca 0-20° ayarlanabilir ışık yönü, bağlantı klipsleri ile lamba panelini ve elleri korur, montajı kolaydır. Ürünümüzü ev, ofis, mağaza, müze, kafe vb. birçok yerde gönül rahatlığı ile tercih edebilirsiniz.

### COB LED ARMATURE

It has a high-quality Led chip. It is a luminaire with an optical screen that is resistant to colour changes and yellowing, is an aluminium injection, electrostatic powder-coated and gives long-lasting homogeneous light. In addition, 0-20° adjustable light direction, connection clips protect the lamp panel and hands. It's easy to install. You can use our product in your home, office, shop, museum, cafe, etc. You can choose from many places with peace of mind.

# COB LED ARMATÜR COB LED ARMATURE

TURQUALITY®

Enerji Verimliliği Sınıfı Energy Efficiency Class	Ürün Kodu Product Code	Güç (W) Power	Renk Sıcaklığı (K) Color Temperature	Işık Akısı (Lm) Luminous Flux	Boyutlar (ØxH) mm Dimensions	Kesme Ebatı (Ø) mm Cutting Size	Koli Adeti Quantity in Carton	Fiyat Price
A T G	BL-COB1-0001	7W	3000 K	700	108 × 65	85	36	\$30,60
A T G	BL-COB1-0002	7W	4000 K	700	108 × 65	85	36	\$30,60
A T G	BL-COB1-0003	7W	6500 K	700	108 × 65	85	36	\$30,60
A T G	BL-COB1-0004	9W	3000 K	900	128 × 55	105	36	\$34,90
A T G	BL-COB1-0005	9W	4000 K	900	128 × 55	105	36	\$34,90
A T G	BL-COB1-0006	9W	6500 K	900	128 × 55	105	36	\$34,90
A T G	BL-COB1-0007	12W	3000 K	1250	150 × 55	130	36	\$41,60
A T G	BL-COB1-0008	12W	4000 K	1250	150 × 55	130	36	\$41,60
A T G	BL-COB1-0009	12W	6500 K	1250	150 × 55	130	36	\$41,60
A T G	BL-COB1-0010	25W	3000 K	2500	200 × 55	180	16	\$56,90
A T G	BL-COB1-0011	25W	4000 K	2500	200 × 55	180	16	\$56,90
A T G	BL-COB1-0012	25W	6500 K	2500	200 × 55	180	16	\$56,90
A T G	BL-COB1-0013	30W	3000 K	3000	240 × 58	210	16	\$61,20
A T G	BL-COB1-0014	30W	4000 K	3000	240 × 58	210	16	\$61,20
A T G	BL-COB1-0015	30W	6500 K	3000	240 × 58	210	16	\$61,20

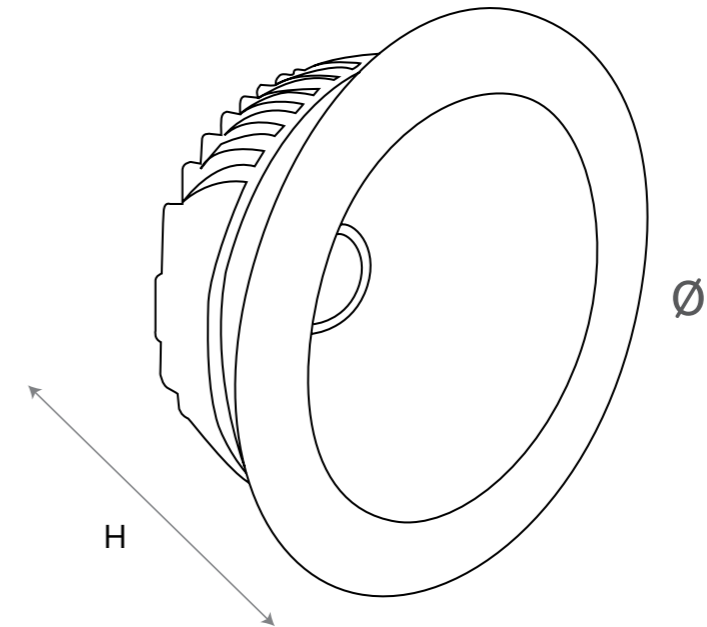

Teknik veri / Datasheet

www.borled.com.tr

# LED MOBİL SPOT LED MOBILE SPOT

## Teknik Özellikler Technical Specifications

Gövde : Polikarbon  
Body : Polycarbon

Sürücü: On-Board  
Driver: DOB

Giriş Gerilimi : 100-265 V AC  
Input Voltage: 100-265 V AC

Renksel Geri Verim : 80  
Color Rendering Index : 80

IP Derecesi : IP20  
IP Rating : IP20

Çalışma Sıcaklığı : -25°C / 40°C  
Operating Temperature Range : -25°C / 40°C



### LED MOBİL SPOT

Uzun ömürlü, dayanıklı, kullanımı kolay ve açısı ayarlanabilir gömme aydınlatma sunan spot optikler, her türlü iç mekanın duvar bölmeleri, raflar, dolaplar, çalışma ve sunum istasyonları, sergi standları vb. panellerin görünümünü güzelleştiren kompakt bir tasarıma sahiptir.

### LED MOBILE SPOT

Offering long-lasting, durable, easy-to-use and adjustable angle recessed lighting, spot optics have a compact design that enhances the appearance of wall bays, shelves, cabinets, work and presentation stations, exhibition stands, etc. panels of all kinds of interiors.

# LED MOBİL SPOT LED MOBILE SPOT

TURQUALITY®

Enerji Verimliliği Sınıfı Energy Efficiency Class	Ürün Kodu Product Code	Güç (W) Power	Renk Sıcaklığı (K) Color Temperature	Işık Akısı (Lm) Luminous Flux	Boyutlar (ØxH) mm Dimensions	Kesme Ebatı (Ø) mm Cutting Size	Renk Color	Koli Adeti Quantity in Carton	Fiyat Price	
A ↑ G	F	BL-MB-0001	5W	3000 K	400	90 X 38	75	Beyaz White	36	\$6,60
A ↑ G	F	BL-MB-0002	5W	4000 K	400	90 X 38	75	Beyaz White	36	\$6,60
A ↑ G	F	BL-MB-0003	5W	6500 K	400	90 X 38	75	Beyaz White	36	\$6,60
A ↑ G	F	BL-MB-1001	5W	3000 K	400	90 X 38	75	Siyah Black	36	\$6,60
A ↑ G	F	BL-MB-1002	5W	4000 K	400	90 X 38	75	Siyah Black	36	\$6,60
A ↑ G	F	BL-MB-1003	5W	6500 K	400	90 X 38	75	Siyah Black	36	\$6,60

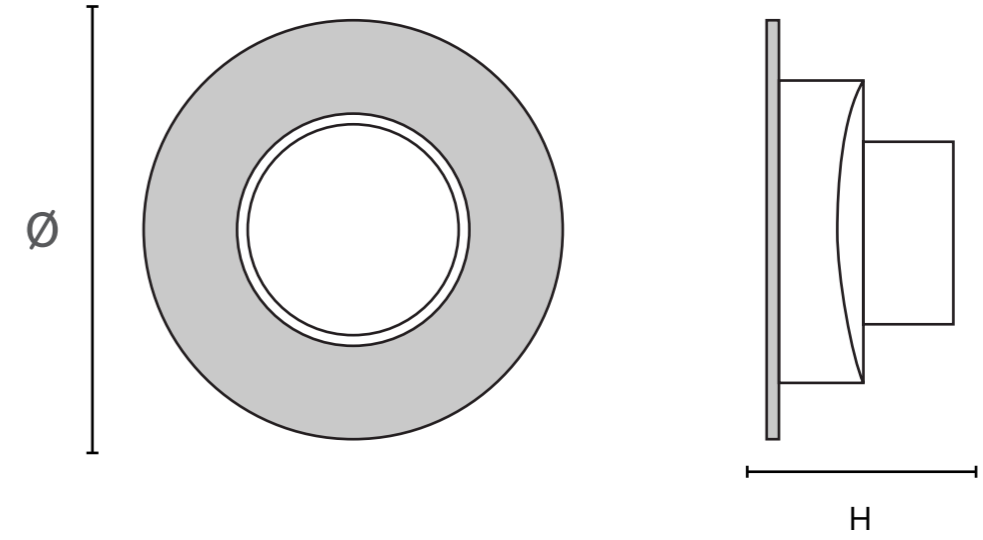



## GU10 DUYLU SPOT GU10 SPOT

### Teknik Özellikler Technical Specifications

Gövde : Alüminyum  
Body : Aluminium

IP Derecesi : IP20  
IP Rating : IP20

Montaj : Sıva Altı  
Mounting : Flush Mounted

Kullanım : GU10 Led/Halojen Ampul  
Usage : GU10 Led/Halogen Bulb

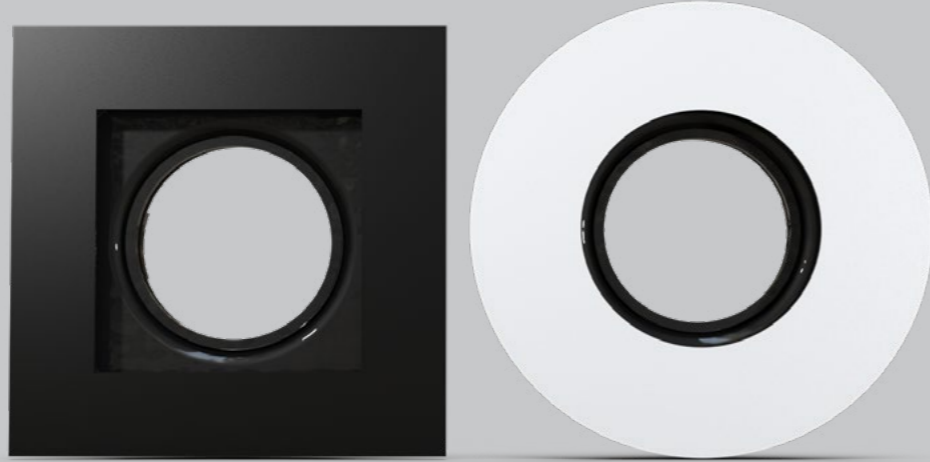

## GU10 DUYLU SPOT (İKİLİ KASA) GU10 SPOT (DOUBLE CASE)

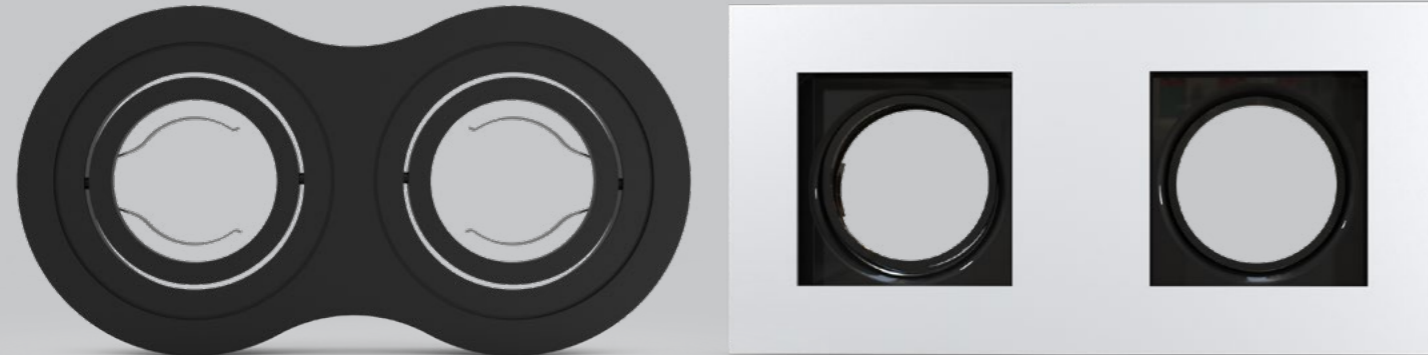

### GU10 DUYLU SPOT

Sıva altı kullanıma uygun, sağlam ve estetik alüminyum alaşım gövde. GU 10 duy tipi ampuller ile Enkandesan ampullerin yerine düşük enerji tüketimi, yüksek ışık çıkışı ve aydınlatma konforu sağlar. Ürünümüzü ev, ofis, mağaza, müze, kafe vb. birçok yerde gönül rahatlığı ile tercih edebilirsiniz.

### GU10 SPOT

Solid and aesthetic aluminium alloy body suitable for flush-mounted use. GU 10 socket type bulbs provide low energy consumption, high light output and lighting comfort instead of incandescent bulbs. You can use our product in your home, office, shop, museum, cafe, etc. You can choose from many places with peace of mind.

## GU10 DUYLU YUVARLAK SPOT GU10 SPOT

Ürün Kodu Product Code	Giriş Voltajı Input Voltage	Duy Tipi Socket Type	Renk Color	Boyutlar (mm) Dimensions	Kesme Ebatı (Ø) mm Cutting Size	Koli Adeti Quantity in Carton	Fiyat Price
BL-GU-1001	220-230 V AC	GU-10	Siyah	100 × 30	85	100	\$10,40
BL-GU-1002	220-230 V AC	GU-10	Beyaz	100 × 30	85	100	\$10,40

## GU10 DUYLU KARE SPOT GU10 SPOT

Ürün Kodu Product Code	Giriş Voltajı Input Voltage	Duy Tipi Socket Type	Renk Color	Boyutlar (mm) Dimensions	Kesme Ebatı (Ø) mm Cutting Size	Koli Adeti Quantity in Carton	Fiyat Price
BL-GU-1003	220-230 V AC	GU-10	Siyah	100 × 100 × 30	85	100	\$11,60
BL-GU-1004	220-230 V AC	GU-10	Beyaz	100 × 100 × 30	85	100	\$11,60

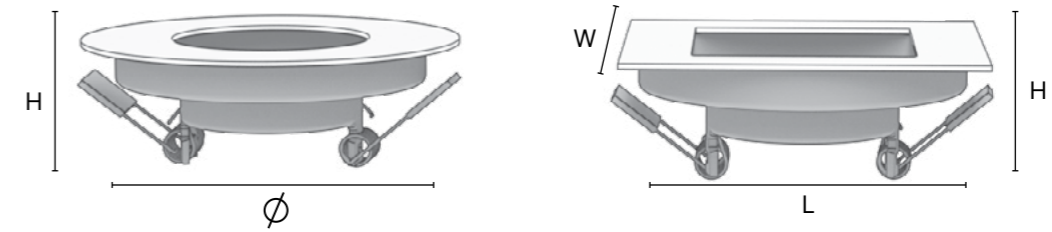

## GU10 DUYLU YUVARLAK SPOT (İKİLİ KASA) GU10 SPOT (DOUBLE CASE)

Ürün Kodu Product Code	Giriş Voltajı Input Voltage	Duy Tipi Socket Type	Renk Color	Boyutlar (WxL) Dimensions	Kesme Ebatı (mm) Cutting Size	Koli Adeti Quantity in Carton	Fiyat Price
BL-GU-2001	220-230 V AC	GU-10	Siyah	100 × 185	85 × 165	40	\$27,00
BL-GU-2002	220-230 V AC	GU-10	Beyaz	100 × 185	85 × 165	40	\$27,00

## GU10 DUYLU KARE SPOT (İKİLİ KASA) GU10 SPOT (DOUBLE CASE)

Ürün Kodu Product Code	Giriş Voltajı Input Voltage	Duy Tipi Socket Type	Renk Color	Boyutlar (WxL) Dimensions	Kesme Ebatı (mm) Cutting Size	Koli Adeti Quantity in Carton	Fiyat Price
BL-GU-2003	220-230 V AC	GU-10	Siyah	100 × 185	85 × 165	40	\$23,40
BL-GU-2004	220-230 V AC	GU-10	Beyaz	100 × 185	85 × 165	40	\$23,40

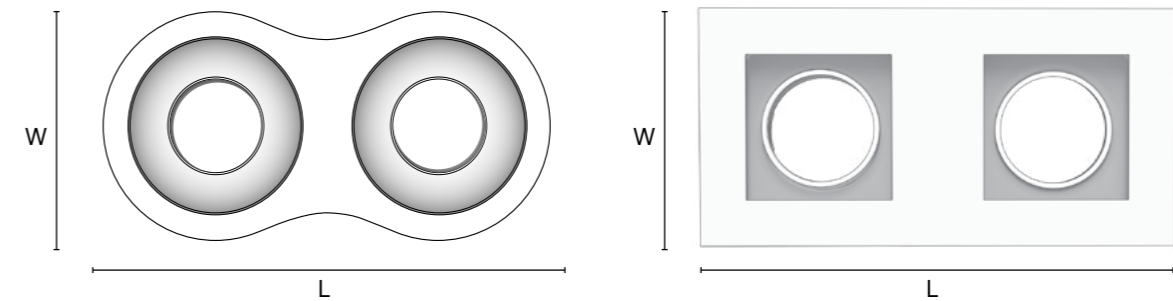

Teknik veri / Datasheet

www.borled.com.tr

## SIVA ÜSTÜ GU10 DUYLU ARMATÜR SURFACE FITTING GU10 ARMATURE

### Teknik Özellikler Technical Specifications

Gövde : Alüminyum  
Body : Aluminium

IP Derecesi : IP20  
IP Rating : IP20

Montaj : Siva Üstü  
Mounting : Surface Mounted

Kullanım : GU10 Led Ampul  
Usage : GU10 Led Bulb

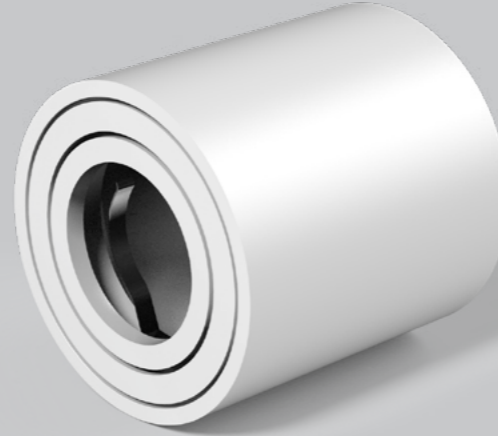
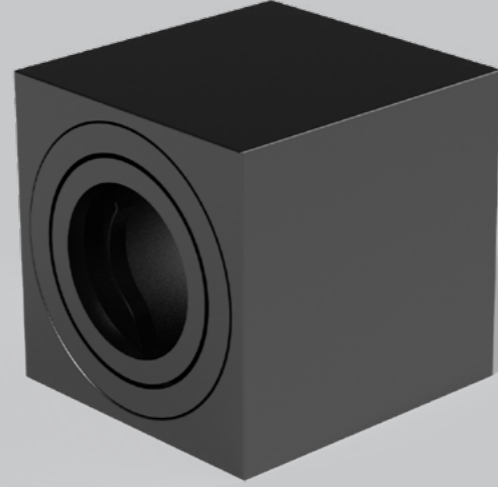

### SIVA ÜSTÜ GU10 DUYLU ARMATÜR

Siva üstü kullanıma uygun, sağlam ve estetik alüminyum alaşım gövde. GU 10 duy tipi ampuller ile Enkandesan ampullerin yerine düşük enerji tüketimi, yüksek ışık çıkışı ve aydınlatma konforu sağlar. Ürünümüzü ev, ofis, mağaza, müze, kafe vb. birçok yerde gönül rahatlığı ile tercih edebilirsiniz.

### SURFACE FITTING GU10 ARMATURE

Durable and aesthetic aluminium alloy body suitable for surface-mounted use. GU 10 socket type bulbs provide low energy consumption, high light output and lighting comfort instead of incandescent bulbs. You can use our product in your home, office, shop, museum, cafe, etc. You can choose from many places with peace of mind.

## KARE SIVA ÜSTÜ GU10 DUYLU ARMATÜR SQUARE SURFACE FITTING GU10 ARMATURE

Ürün Kodu Product Code	Duy Tipi Socket Type	Boyutlar (WxL) mm Dimensions	Renk Color	Koli Adeti Quantity in Carton	Fiyat Price
BL-GU-1005	GU-10	80×80	Siyah	40	\$18,30
BL-GU-1006	GU-10	80×80	Beyaz	40	\$18,30

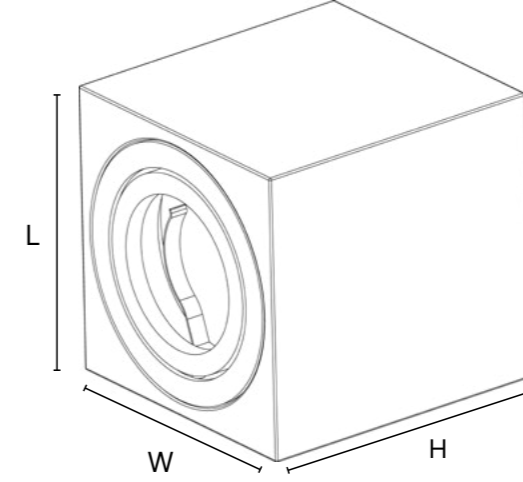

## YUVARLAK SIVA ÜSTÜ GU10 DUYLU ARMATÜR ROUND SURFACE FITTING GU10 ARMATURE

Ürün Kodu Product Code	Duy Tipi Socket Type	Dış Çap mm Outer Diameter	Renk Color	Koli Adeti Quantity in Carton	Fiyat Price
BL-GU-1007	GU-10	80	Siyah	40	\$14,70
BL-GU-1008	GU-10	80	Beyaz	40	\$14,70

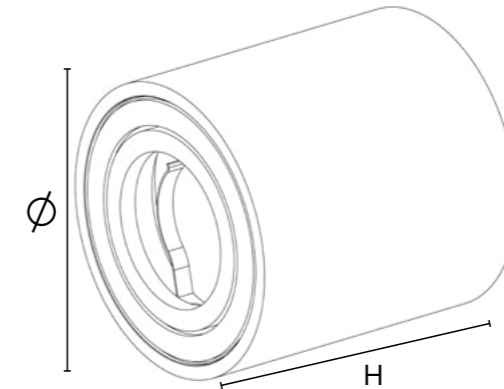

# KARE VE YUVARLAK SPOTLAR

## SQUARE AND ROUND SPOTLIGHTS

### Teknik Özellikler

#### Technical Specifications

Gövde : Alüminyum  
Body : Aluminium

Renk : Siyah/Beyaz  
Color : Black/White

IP Derecesi : IP20  
IP Rating : IP20

Işık Açısı : 8°/15°/24°/36°/60°  
Light Angle : 8°/15°/24°/36°/60°

PF : >0.5  
PF : >0.5

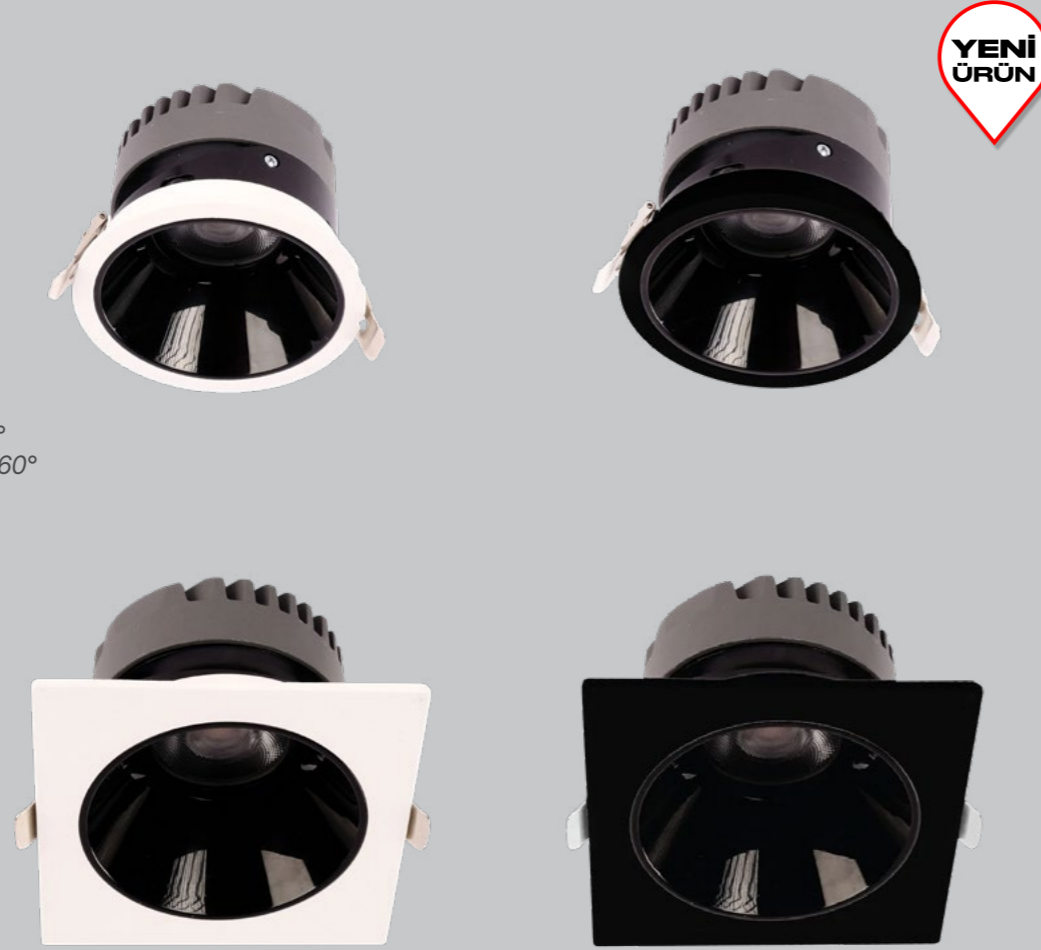

### KARE VE YUVARLAK SPOTLAR

Minimal bir tasarım ve yüksek optik performans ile karakterize edilen bu küçük aydınlatma armatürleri LED'lerle donatılmış olup, vurgudan genel aydınlatmaya kadar çeşitli uygulamalar için uygundur. Gelişmiş optiklerin kullanımı sayesinde dar ve hassas ışık hüzmeleri sunar.

Genellikle kare ışık bir tür modern ışıktır ve ev dekorasyon aydınlatması, restoran aydınlatması ve ofis aydınlatması için daha uygundur. Yuvarlak LED ray ışığı her zaman geleneksel ışıklar olarak görünür ve geleneksel odalar, oteller, dış mekanlar vb. için daha uygun aydınlatmadır.

### SQUARE AND ROUND SPOTLIGHTS

Characterized by a minimal design and high optical performance, these small luminaires equipped with LEDs are suitable for applications ranging from accent to general lighting. Thanks to the use of advanced optics, they offer narrow and precise light beams.

Usually square light is a kind of modern light and is more suitable for home decoration lighting, restaurant lighting and office lighting. Round LED track light always appears as traditional lights and is more suitable lighting for traditional rooms, hotels, outdoor, etc.

### KARE VE YUVARLAK SPOTLAR SIVA ALTI

#### SQUARE AND ROUND SPOTLIGHTS

Enerji Verimliliği S. Energy Efficiency C.	Ürün Kodu Product Code	Güç (W) Power	Renk Sıcaklığı (K) Color Temperature	Işık Akısı (Lm) Luminous Flux	Kullanım Tipi Usage Type	Renk Color	Boyutlar (mm) Dimensions	Gövde Tipi Body Type	Koli Adeti Quantity in Carton	Fiyat Price	
A T G	F	BL-SA-0001	10W	3000K	850	Sıva Altı	Siyah	88×88×80	Kare	20	\$16,00
A T G	F	BL-SA-0002	10W	4000K	850	Sıva Altı	Siyah	88×88×80	Kare	20	\$16,00
A T G	F	BL-SA-0003	10W	6500K	850	Sıva Altı	Siyah	88×88×80	Kare	20	\$16,00
A T G	F	BL-SA-0004	10W	3000K	850	Sıva Altı	Beyaz	88×88×80	Kare	20	\$16,00
A T G	F	BL-SA-0005	10W	4000K	850	Sıva Altı	Beyaz	88×88×80	Kare	20	\$16,00
A T G	F	BL-SA-0006	10W	6500K	850	Sıva Altı	Beyaz	88×88×80	Kare	20	\$16,00
A T G	F	BL-SA-0007	18W	3000K	1530	Sıva Altı	Beyaz	115×115×100	Kare	20	\$27,10
A T G	F	BL-SA-0008	18W	4000K	1530	Sıva Altı	Beyaz	115×115×100	Kare	20	\$27,10
A T G	F	BL-SA-0009	18W	6500K	1530	Sıva Altı	Beyaz	115×115×100	Kare	20	\$27,10
A T G	F	BL-SA-0010	18W	3000K	1530	Sıva Altı	Siyah	115×115×100	Kare	20	\$27,10
A T G	F	BL-SA-0011	18W	4000K	1530	Sıva Altı	Siyah	115×115×100	Kare	20	\$27,10
A T G	F	BL-SA-0012	18W	6500K	1530	Sıva Altı	Siyah	115×115×100	Kare	20	\$27,10
A T G	F	BL-SA-0013	25W	3000K	2125	Sıva Altı	Beyaz	140×140×110	Kare	20	\$37,50
A T G	F	BL-SA-0014	25W	4000K	2125	Sıva Altı	Beyaz	140×140×110	Kare	20	\$37,50
A T G	F	BL-SA-0015	25W	6500K	2125	Sıva Altı	Beyaz	140×140×110	Kare	20	\$37,50
A T G	F	BL-SA-0016	25W	3000K	2125	Sıva Altı	Siyah	140×140×110	Kare	20	\$37,50
A T G	F	BL-SA-0017	25W	4000K	2125	Sıva Altı	Siyah	140×140×110	Kare	20	\$37,50
A T G	F	BL-SA-0018	25W	6500K	2125	Sıva Altı	Siyah	140×140×110	Kare	20	\$37,50
A T G	F	BL-SA-0019	10W	3000K	850	Sıva Altı	Beyaz	Ø88×80	Yuvarlak	20	\$13,20
A T G	F	BL-SA-0020	10W	4000K	850	Sıva Altı	Beyaz	Ø88×80	Yuvarlak	20	\$13,20
A T G	F	BL-SA-0021	10W	6500K	850	Sıva Altı	Beyaz	Ø88×80	Yuvarlak	20	\$13,20
A T G	F	BL-SA-0022	10W	3000K	850	Sıva Altı	Siyah	Ø88×80	Yuvarlak	20	\$13,20
A T G	F	BL-SA-0023	10W	4000K	850	Sıva Altı	Siyah	Ø88×80	Yuvarlak	20	\$13,20
A T G	F	BL-SA-0024	10W	6500K	850	Sıva Altı	Siyah	Ø88×80	Yuvarlak	20	\$13,20
A T G	F	BL-SA-0025	18W	3000K	1530	Sıva Altı	Siyah	Ø105×100	Yuvarlak	20	\$24,30
A T G	F	BL-SA-0026	18W	4000K	1530	Sıva Altı	Siyah	Ø105×100	Yuvarlak	20	\$24,30
A T G	F	BL-SA-0027	18W	6500K	1530	Sıva Altı	Siyah	Ø105×100	Yuvarlak	20	\$24,30
A T G	F	BL-SA-0028	18W	3000K	1530	Sıva Altı	Beyaz	Ø105×100	Yuvarlak	20	\$24,30
A T G	F	BL-SA-0029	18W	4000K	1530	Sıva Altı	Beyaz	Ø105×100	Yuvarlak	20	\$24,30
A T G	F	BL-SA-0030	18W	6500K	1530	Sıva Altı	Beyaz	Ø105×100	Yuvarlak	20	\$24,30
A T G	F	BL-SA-0031	25W	3000K	2125	Sıva Altı	Siyah	Ø134×110	Yuvarlak	20	\$35,50
A T G	F	BL-SA-0032	25W	4000K	2125	Sıva Altı	Siyah	Ø134×110	Yuvarlak	20	\$35,50
A T G	F	BL-SA-0033	25W	6500K	2125	Sıva Altı	Siyah	Ø134×110	Yuvarlak	20	\$35,50
A T G	F	BL-SA-0034	25W	3000K	2125	Sıva Altı	Beyaz	Ø134×110	Yuvarlak	20	\$35,50
A T G	F	BL-SA-0035	25W	4000K	2125	Sıva Altı	Beyaz	Ø134×110	Yuvarlak	20	\$35,50
A T G	F	BL-SA-0036	25W	6500K	2125	Sıva Altı	Beyaz	Ø134×110	Yuvarlak	20	\$35,50



Teknik veri / Datasheet

www.borled.com.tr

# KARE VE YUVARLAK SPOTLAR SQUARE AND ROUND SPOTLIGHTS

## Teknik Özellikler Technical Specifications

Gövde : Alüminyum  
Body : Aluminium

Renk : Siyah/Beyaz  
Color : Black/White

IP Derecesi : IP20  
IP Rating : IP20

Işık Açısı : 8°/15°/24°/36°/60°  
Light Angle : 8°/15°/24°/36°/60°

PF : >0.5  
PF : >0.5



### KARE VE YUVARLAK SPOTLAR

Minimal bir tasarım ve yüksek optik performans ile karakterize edilen bu küçük aydınlatma armatürleri LED'lerle donatılmış olup, vurgudan genel aydınlatmaya kadar çeşitli uygulamalar için uygundur. Gelişmiş optiklerin kullanımı sayesinde dar ve hassas ışık hüzmeleri sunar. Genellikle kare ışık bir tür modern ışıktır ve ev dekorasyon aydınlatması, restoran aydınlatması ve ofis aydınlatması için daha uygundur. Yuvarlak LED ray ışığı her zaman geleneksel ışıklar olarak görünür ve geleneksel odalar, oteller, dış mekanlar vb. için daha uygun aydınlatmadır.

### SQUARE AND ROUND SPOTLIGHTS

Characterized by a minimal design and high optical performance, these small luminaires equipped with LEDs are suitable for applications ranging from accent to general lighting. Thanks to the use of advanced optics, they offer narrow and precise light beams. Usually square light is a kind of modern light and is more suitable for home decoration lighting, restaurant lighting and office lighting. Round LED track light always appears as traditional lights and is more suitable lighting for traditional rooms, hotels, outdoor, etc.

## KARE VE YUVARLAK SPOTLAR SIVA ALTI SQUARE AND ROUND SPOTLIGHTS

Enerji Verimliliği Sınıfı Energy Efficiency Class	Ürün Kodu Product Code	Güç (W) Power	Renk Sıcaklığı (K) Color Temperature	Işık Akısı (Lm) Luminous Flux	Kullanım Tipi Usage Type	Renk Color	Boyutlar (mm) Dimensions	Koli Adeti Quantity in Carton	Fiyat Price
A T G F	BL-SA-0037	2×10W	3000	1700	Sıva Altı	Beyaz	167×88×80	20	\$31,30
A T G F	BL-SA-0038	2×10W	4000	1700	Sıva Altı	Beyaz	167×88×80	20	\$31,30
A T G F	BL-SA-0039	2×10W	6500	1700	Sıva Altı	Beyaz	167×88×80	20	\$31,30
A T G F	BL-SA-0040	2×10W	3000	1700	Sıva Altı	Siyah	167×88×80	20	\$31,30
A T G F	BL-SA-0041	2×10W	4000	1700	Sıva Altı	Siyah	167×88×80	20	\$31,30
A T G F	BL-SA-0042	2×10W	6500	1700	Sıva Altı	Siyah	167×88×80	20	\$31,30
A T G F	BL-SA-0043	2×18W	3000	3060	Sıva Altı	Beyaz	216×115×100	20	\$54,20
A T G F	BL-SA-0044	2×18W	4000	3060	Sıva Altı	Beyaz	216×115×100	20	\$54,20
A T G F	BL-SA-0045	2×18W	6500	3060	Sıva Altı	Beyaz	216×115×100	20	\$54,20
A T G F	BL-SA-0046	2×18W	3000	3060	Sıva Altı	Siyah	216×115×100	20	\$54,20
A T G F	BL-SA-0047	2×18W	4000	3060	Sıva Altı	Siyah	216×115×100	20	\$54,20
A T G F	BL-SA-0048	2×18W	6500	3060	Sıva Altı	Siyah	216×115×100	20	\$54,20
A T G F	BL-SA-0049	2×25W	3000	4250	Sıva Altı	Beyaz	265×140×110	20	\$74,40
A T G F	BL-SA-0050	2×25W	4000	4250	Sıva Altı	Beyaz	265×140×110	20	\$74,40
A T G F	BL-SA-0051	2×25W	6500	4250	Sıva Altı	Beyaz	265×140×110	20	\$74,40
A T G F	BL-SA-0052	2×25W	3000	4250	Sıva Altı	Siyah	265×140×110	20	\$74,40
A T G F	BL-SA-0053	2×25W	4000	4250	Sıva Altı	Siyah	265×140×110	20	\$74,40
A T G F	BL-SA-0054	2×25W	6500	4250	Sıva Altı	Siyah	265×140×110	20	\$74,40
A T G F	BL-SA-0055	3×10W	3000	2250	Sıva Altı	Beyaz	250×88×80	20	\$47,30
A T G F	BL-SA-0056	3×10W	4000	2250	Sıva Altı	Beyaz	250×88×80	20	\$47,30
A T G F	BL-SA-0057	3×10W	6500	2250	Sıva Altı	Beyaz	250×88×80	20	\$47,30
A T G F	BL-SA-0058	3×10W	3000	2250	Sıva Altı	Siyah	250×88×80	20	\$47,30
A T G F	BL-SA-0059	3×10W	4000	2250	Sıva Altı	Siyah	250×88×80	20	\$47,30
A T G F	BL-SA-0060	3×10W	6500	2250	Sıva Altı	Siyah	250×88×80	20	\$47,30
A T G F	BL-SA-0061	3×18W	3000	4590	Sıva Altı	Siyah	324×115×100	20	\$80,60
A T G F	BL-SA-0062	3×18W	4000	4590	Sıva Altı	Siyah	324×115×100	20	\$80,60
A T G F	BL-SA-0063	3×18W	6500	4590	Sıva Altı	Siyah	324×115×100	20	\$80,60
A T G F	BL-SA-0064	3×18W	3000	4590	Sıva Altı	Beyaz	324×115×100	20	\$80,60
A T G F	BL-SA-0065	3×18W	4000	4590	Sıva Altı	Beyaz	324×115×100	20	\$80,60
A T G F	BL-SA-0066	3×18W	6500	4590	Sıva Altı	Beyaz	324×115×100	20	\$80,60
A T G F	BL-SA-0067	3×25W	3000	6375	Sıva Altı	Beyaz	398×140×110	20	\$111,20
A T G F	BL-SA-0068	3×25W	4000	6375	Sıva Altı	Beyaz	398×140×110	20	\$111,20
A T G F	BL-SA-0069	3×25W	6500	6375	Sıva Altı	Beyaz	398×140×110	20	\$111,20
A T G F	BL-SA-0070	3×25W	3000	6375	Sıva Altı	Siyah	398×140×110	20	\$111,20
A T G F	BL-SA-0071	3×25W	4000	6375	Sıva Altı	Siyah	398×140×110	20	\$111,20
A T G F	BL-SA-0072	3×25W	6500	6375	Sıva Altı	Siyah	398×140×110	20	\$111,20



# ALÜMİNYUM LED APLİK ALUMINIUM LED APPLIQUE

## Teknik Özellikler Technical Specifications

Gövde : Alüminyum  
Body : Aluminium

Renk : Siyah/Beyaz  
Color : Black/White

IP Derecesi : IP20  
IP Rating : IP20

Giriş Gerilimi : 85-265V AC  
Input Voltage : 85-265V AC

Renksel Geri Verim : 80  
Color Rendering Index : 80

Işık Açısı : 8°/24°/36°  
Light Angle : 8°/24°/36°

PF : >0.5  
PF : >0.5



## ALÜMİNYUM LED APLİK

LED Ray Spotlar; başta mağaza, müze, sahne, kafe, restoran, ofis vb. birçok yerde kullanılan aydınlatma armatürleridir. Tavana veya duvara monte edilmiş ray aparatı üzerinde hareket edebilir ve kendi ekseninde 360° yön değiştirerek vitrin, raf, stand ve reyon gibi belirli bölgeleri aydınlatarak dikkat çekerler. LED Ray Spotlar, düşük enerji tüketerek yüksek ışık gücü sağlarken, uzun kullanım ömrüne ve estetik bir görünüme sahiptir.

## ALUMINIUM LED APPLIQUE

LED Rail Spots; mainly for the shop, museum, stage, cafe, restaurant, office etc. They are lighting fixtures used in many places. They can move on the ceiling or wallmounted rail apparatus and change direction 360° on their axis, attracting attention by illuminating certain areas such as showcases, shelves, stands and sections. LED Rail Spots provide high light power by consuming low energy and have a long service life and aesthetic appearance

# ALÜMİNYUM LED APLİK ALUMINIUM LED APPLIQUE

TURQUALITY®

Enerji Verimliliği Sınıfı Energy Efficiency Class	Ürün Kodu Product Code	Güç (W) Power	Renk Sıcaklığı (K) Color Temperature	Işık Akısı (Lm) Luminous Flux	Renk Color	Boyutlar (mm) Dimensions	Koli Adeti Quantity in Carton	Fiyat Price
A F	BL-AA-0001	3W	3000 K	270	Beyaz-White	150×50×65	40	\$29,80
A F	BL-AA-0002	3W	4000 K	270	Beyaz-White	150×50×65	40	\$29,80
A F	BL-AA-0003	3W	6500 K	270	Beyaz-White	150×50×65	40	\$29,80
A F	BL-AA-0004	3W	3000 K	270	Siyah-Black	150×50×65	40	\$29,80
A F	BL-AA-0005	3W	4000 K	270	Siyah-Black	150×50×65	40	\$29,80
A F	BL-AA-0006	3W	6500 K	270	Siyah-Black	150×50×65	40	\$29,80



## RAY SPOT GU10 DUYLU ARMATÜR RAIL SPOT GU10 WITH SOCKET ARMATURE

### Teknik Özellikler Technical Specifications

Gövde : Alüminyum  
Body : Aluminium

IP Derecesi : IP20  
IP Rating : IP20

Montaj : Ray  
Mounting : Rail

Kullanım : GU10 Led Ampul  
Usage : GU10 Led Bulb



### GU10 DUYLU RAY SPOT

GU10 Duylu Ray Spotlar; başta mağaza, müze, sahne, kafe, restoran, ofis vb. birçok yerde kullanılan aydınlatma armatürleridir. Tavana veya duvara monte edilmiş ray aparatı üzerinde hareket edebilir ve kendi ekseninde 360° yön değiştirerek vitrin, raf, stand ve reyon gibi belirli bölgeleri aydınlatarak dikkat çekerler.

GU 10 duy tipi ampuller ile Enkandesan ampullerin yerine düşük enerji tüketimi, yüksek ışık çıkışı ve aydınlatma konforu sağlar.

### RAIL SPOT GU10 WITH SOCKET ARMATURE

GU10 With Socket Rail Spots; mainly for the shop, museum, stage, cafe, restaurant, office etc. They are lighting fixtures used in many places. They can move on the ceiling or wall-mounted rail apparatus and change direction 360° on their axis, attracting attention by illuminating certain areas such as showcases, shelves, stands and sections.

GU 10 socket type bulbs provide low energy consumption, high light output and lighting comfort instead of incandescent bulbs.

## RAY SPOT GU10 DUYLU ARMATÜR RAIL SPOT GU10 WITH SOCKET ARMATURE

Ürün Kodu Product Code	Giriş Voltajı Input Voltage	Duy Tipi Socket Type	Renk Color	İç Çap Ø (mm) Inner Diameter	Koli Adeti Quantity in Carton	Fiyat Price
BL-GU-1010	220-230 V AC	GU-10	Siyah	55	40	\$20,30
BL-GU-1011	220-230 V AC	GU-10	Beyaz	55	40	\$20,30

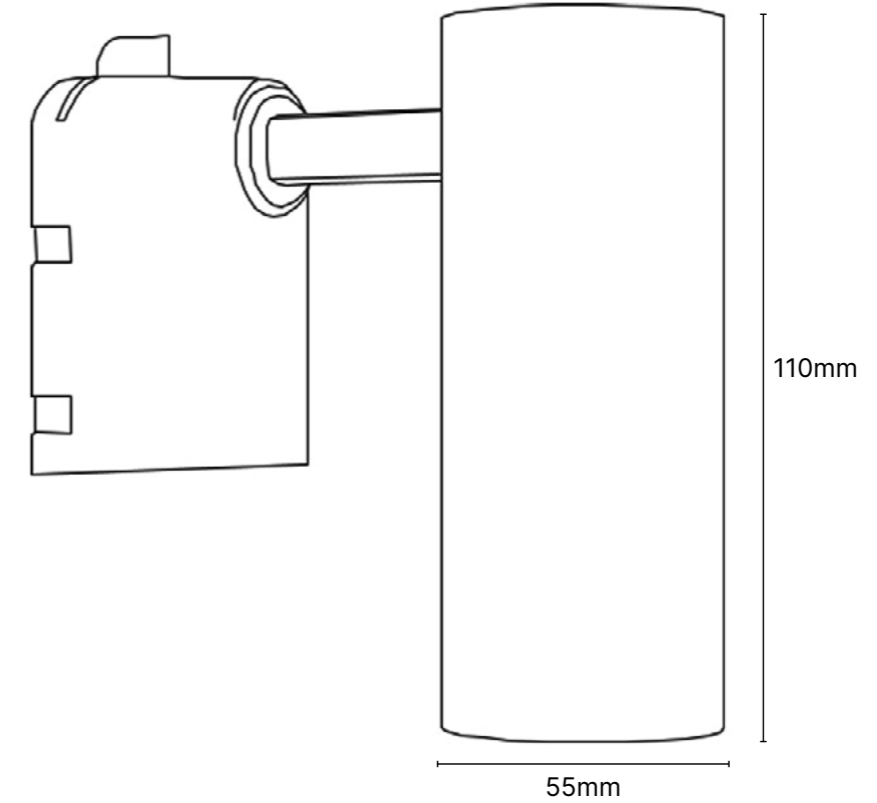

# KONUT TİPİ RAY SPOT

## RAY SPOT HOUSING TYPE

### Teknik Özellikler

#### Technical Specifications



Gövde : Alüminyum  
Body : Aluminium

Renk : Siyah/Beyaz  
Color : Black/White

IP Derecesi : IP20  
IP Rating : IP20

Giriş Gerilimi : 175-265V/50-60 Hz  
Input Voltage: 175-265V/50-60 Hz

Renksel Geri Verim : 80  
Color Rendering Index : 80

Işık Açısı : 15° / 24° / 36° / 55°  
Light Angle : 15° / 24° / 36° / 55°

PF : >0.5  
PF : >0.5

Flicker: Flicker Free



### KONUT TİPİ RAY SPOT

LED Ray Spotlar; başta mağaza, müze, sahne, kafe, restoran, ofis vb. birçok yerde kullanılan aydınlatma armatürleridir. Tavana veya duvara monte edilmiş ray aparatı üzerinde hareket edebilir ve kendi ekseninde 360° yön değiştirerek vitrin, raf, stand ve reyon gibi belirli bölgeleri aydınlatarak dikkat çekerler. LED Ray Spotlar, düşük enerji tüketerek yüksek ışık gücü sağlarken, uzun kullanım ömrüne ve estetik bir görünüme sahiptir.

### RAY SPOT HOUSING TYPE

LED Rail Spots; mainly for the shop, museum, stage, cafe, restaurant, office etc. They are lighting fixtures used in many places. They can move on the ceiling or wallmounted rail apparatus and change direction 360° on their axis, attracting attention by illuminating certain areas such as showcases, shelves, stands and sections. LED Rail Spots provide high light power by consuming low energy and have a long service life and aesthetic appearance

### KONUT TİPİ RAY SPOT

#### RAY SPOT HOUSING TYPE

Enerji Verimliliği Sınıfı Energy Efficiency Class	Ürün Kodu Product Code	Güç (W) Power	Renk Sıcaklığı (K) Color Temperature	Işık Akısı (Lm) Luminous Flux	Renk Color	Boyutlar (mm) Dimensions	Koli Adeti Quantity in Carton	Fiyat Price
A T G	BL-KT-0001	10W	3000 K	1200	Beyaz-White	50 x 140	12	\$17.20
A T G	BL-KT-0002	10W	4000 K	1200	Beyaz-White	50 x 140	12	\$17.20
A T G	BL-KT-0003	10W	6500 K	1200	Beyaz-White	50 x 140	12	\$17.20
A T G	BL-KT-0004	30W	3000 K	3600	Beyaz-White	75 x 180	12	\$17.20
A T G	BL-KT-0005	30W	4000 K	3600	Beyaz-White	75 x 180	12	\$17.20
A T G	BL-KT-0006	30W	6500 K	3600	Beyaz-White	75 x 180	12	\$17.20
A T G	BL-KT-0007	10W	3000 K	1200	Siyah-Black	50 x 140	12	\$20.90
A T G	BL-KT-0008	10W	4000 K	1200	Siyah-Black	50 x 140	12	\$20.90
A T G	BL-KT-0009	10W	6500 K	1200	Siyah-Black	50 x 140	12	\$20.90
A T G	BL-KT-0010	30W	3000 K	3600	Siyah-Black	75 x 180	12	\$20.90
A T G	BL-KT-0011	30W	4000 K	3600	Siyah-Black	75 x 180	12	\$20.90
A T G	BL-KT-0012	30W	6500 K	3600	Siyah-Black	75 x 180	12	\$20.90



# YUVARLAK LED RAY SPOTLAR ROUND LED RAIL SPOTLIGHTS

## Teknik Özellikler Technical Specifications

Gövde : Alüminyum  
Body : Aluminium

Renk : Siyah/Beyaz  
Color : Black/White

IP Derecesi : IP20  
IP Rating : IP20

Giriş Gerilimi : 85-265V AC  
Input Voltage: 85-265V AC

Renksel Geri Verim : 80  
Color Rendering Index : 80

Işık Açısı : 8°/24°/36°  
Light Angle : 8°/24°/36°

PF : >0.5  
PF : >0.5



### YUVARLAK LED RAY SPOTLAR

LED Ray Spotlar; başta mağaza, müze, sahne, kafe, restoran, ofis vb. birçok yerde kullanılan aydınlatma armatürleridir. Tavana veya duvara monte edilmiş ray aparatı üzerinde hareket edebilir ve kendi ekseninde 360° yön değiştirerek vitrin, raf, stand ve reyon gibi belirli bölgeleri aydınlatarak dikkat çekerler. LED Ray Spotlar, düşük enerji tüketerek yüksek ışık gücü sağlarken, uzun kullanım ömrüne ve estetik bir görünüme sahiptir.

### ROUND LED RAIL SPOTLIGHTS

LED Rail Spots; mainly for the shop, museum, stage, cafe, restaurant, office etc. They are lighting fixtures used in many places. They can move on the ceiling or wallmounted rail apparatus and change direction 360° on their axis, attracting attention by illuminating certain areas such as showcases, shelves, stands and sections. LED Rail Spots provide high light power by consuming low energy and have a long service life and aesthetic appearance

## YUVARLAK LED RAY SPOTLAR ROUND LED RAIL SPOTLIGHTS

TURQUALITY®

Enerji Verimliliği Sınıfı Energy Efficiency Class	Ürün Kodu Product Code	Güç (W) Power	Renk Sıcaklığı (K) Color Temperature	Işık Akısı (Lm) Luminous Flux	Renk Color	Boyutlar (mm) Dimensions	Koli Adeti Quantity in Carton	Fiyat Price
A F	BL-RS-0007	30W	3000 K	2700	Siyah Black	100×190×100	16	\$36,30
A F	BL-RS-0008	30W	4000 K	2700	Siyah Black	100×190×100	16	\$36,30
A F	BL-RS-0009	30W	6500 K	2700	Siyah Black	100×190×100	16	\$36,30
A F	BL-RS-0004	30W	3000 K	2700	Beyaz White	100×190×100	16	\$36,30
A F	BL-RS-0005	30W	4000 K	2700	Beyaz White	100×190×100	16	\$36,30
A F	BL-RS-0006	30W	6500 K	2700	Beyaz White	100×190×100	16	\$36,30





# LED RAY SPOT LED RAIL SPOT

## Teknik Özellikler Technical Specifications

Gövde : Alüminyum  
Body : Aluminium

Cam : Akrilik  
Glass : Acrylic

Renksel Geri Verim : 80  
Color Rendering Index : 80

IP Derecesi : IP20  
IP Rating : IP20

IK Derecesi : IK03  
IK Rating : IK03

Elektriksel Koruma : Sınıf I  
Electrical Protection : Class I



### LED RAY SPOT

LED Ray Spotlar; başta mağaza, müze, sahne, kafe, restoran, ofis vb. birçok yerde kullanılan aydınlatma armatürleridir. Tavana veya duvara monte edilmiş ray aparatı üzerinde hareket edebilir ve kendi ekseninde 360° yön değiştirerek vitrin, raf, stand ve reyon gibi belirli bölgeleri aydınlatarak dikkat çekerler.

LED Ray Spotlar, düşük enerji tüketerek yüksek ışık gücü sağlarken, uzun kullanım ömrüne ve estetik bir görünüme sahiptir.

### LED RAIL SPOT

LED Rail Spots; mainly for the shop, museum, stage, cafe, restaurant, office etc. They are lighting fixtures used in many places. They can move on the ceiling or wall-mounted rail apparatus and change direction 360° on their axis, attracting attention by illuminating certain areas such as showcases, shelves, stands and sections.

LED Rail Spots provide high light power by consuming low energy and have a long service life and aesthetic appearance.

## LED RAY SPOT MONOFAZE LED RAIL SPOT MONOPHASE

Enerji Verimliliği Sınıfı Energy Efficiency Class	Ürün Kodu Product Code	Güç (W) Power	Renk Sıcaklığı (K) Color Temperature	Işık Akısı (Lm) Luminous Flux	Boyutlar (Ø) mm Dimensions	Renk Color	Koli Adeti Quantity in Carton	Fiyat Price
A+G E	BL-RS-0001	40W	3000 K	4000	115	Siyah-Black	24	\$81,40
A+G E	BL-RS-0002	40W	4000 K	4000	115	Siyah-Black	24	\$81,40
A+G E	BL-RS-0003	40W	6500 K	4000	115	Siyah-Black	24	\$81,40
A+G E	BL-RS-1001	40W	3000 K	4000	115	Beyaz-White	24	\$81,40
A+G E	BL-RS-1002	40W	4000 K	4000	115	Beyaz-White	24	\$81,40
A+G E	BL-RS-1003	40W	6500 K	4000	115	Beyaz-White	24	\$81,40
A+G E	BL-RS-1004	30W	3000 K	3000	115	Siyah-Black	24	\$81,40
A+G E	BL-RS-1005	30W	4000 K	3000	115	Siyah-Black	24	\$81,40
A+G E	BL-RS-1006	30W	6500 K	3000	115	Siyah-Black	24	\$81,40
A+G E	BL-RS-1007	30W	3000 K	3000	115	Beyaz-White	24	\$81,40
A+G E	BL-RS-1008	30W	4000 K	3000	115	Beyaz-White	24	\$81,40
A+G E	BL-RS-1009	30W	6500 K	3000	115	Beyaz-White	24	\$81,40

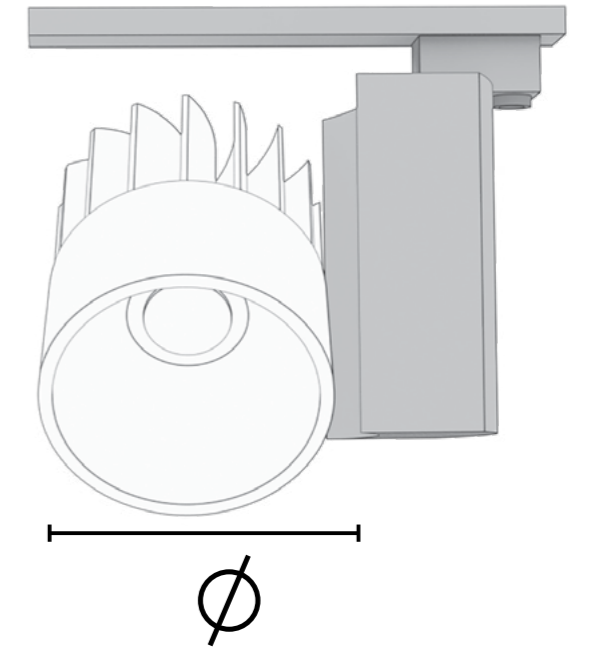
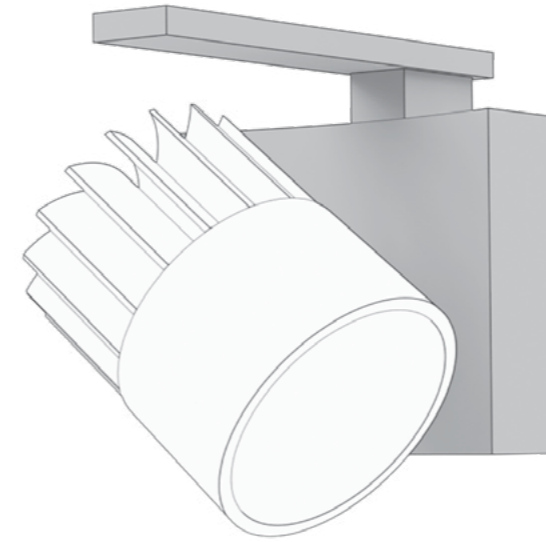

# KATLANABİLİR MAGNET RAY SPOT

## FOLDABLE MAGNET RAIL SPOTLIGHT

### Teknik Özellikler

#### Technical Specifications

Gövde : Alüminyum  
Body : Aluminium

Cam : Akrilik  
Glass : Acrylic

Renksel Geri Verim : 80  
Color Rendering Index : 80

IP Derecesi : IP20  
IP Rating : IP20

IK Derecesi : IK03  
IK Rating : IK03

PF : >0.5  
PF : >0.5

Işık Açısı : 24°  
Light Angle : 24°

Çalışma Sıcaklığı : -20°C / 45°C  
Operating Temp. Range : -20°C / 45°C

Flicker : Flicker Free



### KATLANABİLİR MAGNET RAY SPOT

Estetik ve işlevi mükemmel bir şekilde birleştirerek enerji verimliliği ile uzun vadeli tasarruf sağlar. Evinizin bir köşesini aydınlatmak veya iş yerinizdeki çalışma alanınızı vurgulamak için kullanın. Tasarımının özgürlüğü ve manyetik montaj seçeneği, aydınlatma ihtiyaçlarınıza göre özelleştirmenize olanak tanır.

### FOLDABLE MAGNET RAIL SPOTLIGHT

It perfectly combines aesthetics and function, providing long-term savings with energy efficiency. Use it to illuminate a corner of your home or to highlight your workspace in your workplace. The freedom of its design and magnetic mounting option allow you to customize it according to your lighting needs.

### KATLANABİLİR MAGNET RAY SPOT

#### FOLDABLE MAGNET RAIL SPOTLIGHT

Enerji Verimliliği Sınıfı Energy Efficiency Class	Ürün Kodu Product Code	Güç (W) Power	Renk Sıcaklığı (K) Color Temperature	Işık Akısı (Lm) Luminous Flux	Boyutlar (mm) Dimensions	Renk Color	Koli Adeti Quantity in Carton	Fiyat Price
A F G	BL-SK-0001	6W	3000 K	520	135×22×43	Siyah-Black	50	\$22,60
A F G	BL-SK-0002	6W	4000 K	520	135×22×43	Siyah-Black	50	\$22,60
A F G	BL-SK-0003	6W	6500 K	520	135×22×43	Siyah-Black	50	\$22,60
A F G	BL-SK-0004	12W	3000 K	1040	230×22×43	Siyah-Black	50	\$32,20
A F G	BL-SK-0005	12W	4000 K	1040	230×22×43	Siyah-Black	50	\$32,20
A F G	BL-SK-0006	12W	6500 K	1040	230×22×43	Siyah-Black	50	\$32,20
A F G	BL-SK-0007	18W	3000 K	1560	370×22×43	Siyah-Black	50	\$42,20
A F G	BL-SK-0008	18W	4000 K	1560	370×22×43	Siyah-Black	50	\$42,20
A F G	BL-SK-0009	18W	6500 K	1560	370×22×43	Siyah-Black	50	\$42,20



# KATLANABİLİR YUVARLAK MAGNET RAY SPOT

## FOLDABLE ROUND MAGNET RAIL SPOTLIGHT

### Teknik Özellikler

#### Technical Specifications

Gövde : Alüminyum  
Body : Aluminium

Cam : Akrilik  
Glass : Acrylic

Renksel Geri Verim : 80  
Color Rendering Index : 80

IP Derecesi : IP20  
IP Rating : IP20

IK Derecesi : IK03  
IK Rating : IK03

PF : >0.5  
PF : >0.5

Işık Açısı : 24°  
Light Angle : 24°

Çalışma Sıcaklığı : -20°C / 45°C  
Operating Temp. Range : -20°C / 45°C

Flicker : Flicker Free



### KATLANABİLİR YUVARLAK MAGNET RAY SPOT

Estetik ve işlevi mükemmel bir şekilde birleştirerek enerji verimliliği ile uzun vadeli tasarruf sağlar. Evinizin bir köşesini aydınlatmak veya iş yerinizdeki çalışma alanınızı vurgulamak için kullanın. Tasarımının özgürlüğü ve manyetik montaj seçeneği, aydınlatma ihtiyaçlarınıza göre özelleştirmenize olanak tanır.

### FOLDABLE ROUND MAGNET RAIL SPOTLIGHT

It perfectly combines aesthetics and function, providing long-term savings with energy efficiency. Use it to illuminate a corner of your home or to highlight your workspace in your workplace. The freedom of its design and magnetic mounting option allow you to customize it according to your lighting needs.

# KATLANABİLİR YUVARLAK MAGNET RAY SPOT

## FOLDABLE ROUND MAGNET RAIL SPOTLIGHT

Enerji Verimliliği Sınıfı Energy Efficiency Class	Ürün Kodu Product Code	Güç (W) Power	Renk Sıcaklığı (K) Color Temperature	Işık Akısı (Lm) Luminous Flux	Boyutlar (mm) Dimensions	Renk Color	Koli Adeti Quantity in Carton	Fiyat Price
A+G	BL-YK-0001	6W	3000 K	390	35×80	Siyah-Black	50	\$34,60
A+G	BL-YK-0002	6W	4000 K	390	35×80	Siyah-Black	50	\$34,60
A+G	BL-YK-0003	6W	6500 K	390	35×80	Siyah-Black	50	\$34,60
A+G	BL-YK-0004	12W	3000 K	780	45×100	Siyah-Black	50	\$42,10
A+G	BL-YK-0005	12W	4000 K	780	45×100	Siyah-Black	50	\$42,10
A+G	BL-YK-0006	12W	6500 K	780	45×100	Siyah-Black	50	\$42,10
A+G	BL-YK-0007	18W	3000 K	1170	55×120	Siyah-Black	50	\$52,50
A+G	BL-YK-0008	18W	4000 K	1170	55×120	Siyah-Black	50	\$52,50
A+G	BL-YK-0009	18W	6500 K	1170	55×120	Siyah-Black	50	\$52,50
A+G	BL-YK-0010	25W	3000 K	1625	65×140	Siyah-Black	50	\$62,50
A+G	BL-YK-0011	25W	4000 K	1625	65×140	Siyah-Black	50	\$62,50
A+G	BL-YK-0012	25W	6500 K	1625	65×140	Siyah-Black	50	\$62,50



# DİFÜZÖRLÜ MAGNET RAY SPOT MAGNET RAIL SPOT WITH DIFFUSER

## Teknik Özellikler Technical Specifications



Gövde : Alüminyum  
Body : Aluminium

Cam : Akrilik  
Glass : Acrylic

Renksel Geri Verim : 80  
Color Rendering Index : 80

IP Derecesi : IP20  
IP Rating : IP20

IK Derecesi : IK03  
IK Rating : IK03

PF : >0.5  
PF : >0.5

Işık Açısı : 24°  
Light Angle : 24°

Çalışma Sıcaklığı : -20°C / 45°C  
Operating Temp. Range : -20°C / 45°C

Flicker : Flicker Free



## DİFÜZÖRLÜ MAGNET RAY SPOT

Estetik ve işlevi mükemmel bir şekilde birleştirerek enerji verimliliği ile uzun vadeli tasarruf sağlar. Evinizin bir köşesini aydınlatmak veya iş yerinizdeki çalışma alanınızı vurgulamak için kullanın. Tasarımının özgürlüğü ve manyetik montaj seçeneği, aydınlatma ihtiyaçlarınıza göre özelleştirmenize olanak tanır.

## MAGNET RAIL SPOT WITH DIFFUSER

It perfectly combines aesthetics and function, providing long-term savings with energy efficiency. Use it to illuminate a corner of your home or to highlight your workspace in your workplace. The freedom of its design and magnetic mounting option allow you to customize it according to your lighting needs.

# DİFÜZÖRLÜ MAGNET RAY SPOT MAGNET RAIL SPOT WITH DIFFUSER

TURQUALITY®

Enerji Verimliliği Sınıfı Energy Efficiency Class	Ürün Kodu Product Code	Güç (W) Power	Renk Sıcaklığı (K) Color Temperature	Işık Akısı (Lm) Luminous Flux	Boyutlar (mm) Dimensions	Renk Color	Koli Adeti Quantity in Carton	Fiyat Price
A F G	BL-MD-0001	10W	3000 K	550	135×22×43	Siyah-Black	50	\$22,70
A F G	BL-MD-0002	10W	4000 K	550	135×22×43	Siyah-Black	50	\$22,70
A F G	BL-MD-0003	10W	6500 K	550	135×22×43	Siyah-Black	50	\$22,70
A F G	BL-MD-0004	15W	3000 K	825	230×22×43	Siyah-Black	50	\$30,60
A F G	BL-MD-0005	15W	4000 K	825	230×22×43	Siyah-Black	50	\$30,60
A F G	BL-MD-0006	15W	6500 K	825	230×22×43	Siyah-Black	50	\$30,60
A F G	BL-MD-0007	30W	3000 K	1650	370×22×43	Siyah-Black	50	\$34,80
A F G	BL-MD-0008	30W	4000 K	1650	370×22×43	Siyah-Black	50	\$34,80
A F G	BL-MD-0009	30W	6500 K	1650	370×22×43	Siyah-Black	50	\$34,80

HASTANE  
HOSPITAL

borled®  
by borsan

39

Teknik veri / Datasheet

www.borled.com.tr

# MAGNET RAY SPOT APARATLARI

## MAGNET RAYS & SPOT APPARATUS

### Teknik Özellikler

#### Technical Specifications

Gövde : Alüminyum  
Body : Aluminium

Renksel : Siyah  
Color : Black

IP Derecesi : IP20  
IP Rating : IP20

Çalışma Sıcaklığı : -20°C / 45°C  
Operating Temp. Range : -20°C / 45°C



Arabağlantı Konnektörü  
Interconnect Connector



30 cm Kablolu Soket  
30 cm Wired Socket



Driver 100W - 200W

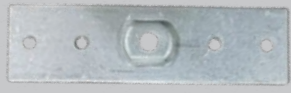

Sıva Üstü Montaj Demiri  
Surface Mounting Iron



Sarkıt Aparatları  
Pendant Apparatus



12 cm Kablolu Arabağlantı Konnektörü  
12 cm Wired Interconnect Connector

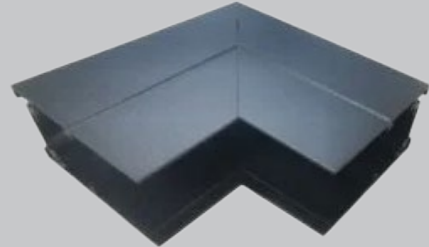

L Dönüş (Sıva Üstü - Tavandan Duvara)  
L Connector (Ceiling to Wall)

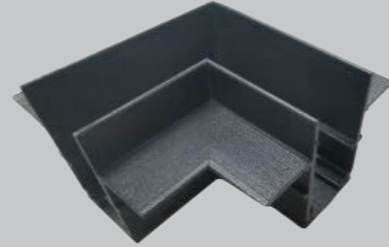

L Dönüş (Sıva Altı - Tavan)  
L Return (Recessed - Ceiling)

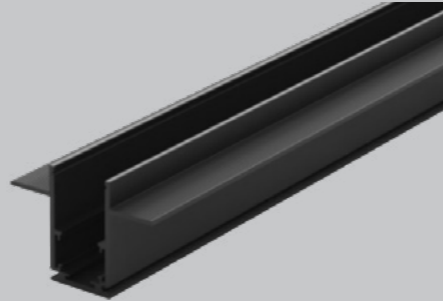

H Tipi Model  
H Type Model



L Dönüş (Sıva Üstü-Tavan)  
L Connector (Surface Mounted Ceiling)

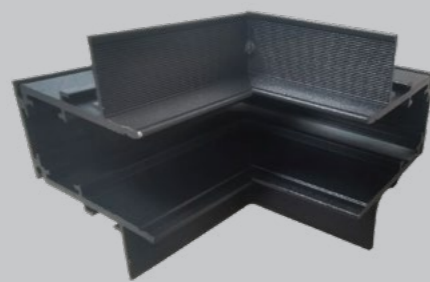

L Dönüş (Sıva Altı-Tavandan Duvara)  
L Connector (Recessed to Wall)

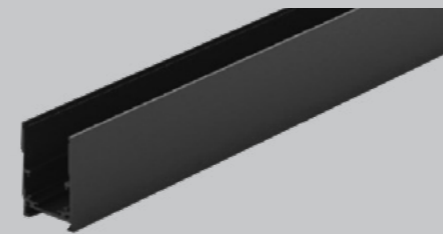

Derin Sıva Üstü Ray  
Deep Surface Mounted Rail

### MAGNET RAY SPOT APARATLARI

Raylı led spot aydınlatmalar ile birlikte kullanılan çeşitli aksesuarlar bulunur. Ray, ara bağlantı aparatı, soket, T dönüş, L dönüş, köşe dönüş, askı aparatı, sonlandırma kapağı, artı dönüş, enerji girişi, ray soketi vb ek parça ürünlerdir.

### MAGNET RAYS & SPOT APPARATUS

There are various accessories used with rail led spotlights. Rail, interconnection apparatus, socket, T turn, L turn, corner turn, suspension apparatus, termination cover, plus turn, energy input, rail socket etc. are additional part products.

### 30 cm KABLULU SOKET

#### 30 cm Wired Socket

Ürün Kodu Product Code	Koli Adeti Quantity in Carton	Fiyat Price
131-1650	100	\$6,2

### SIVA ÜSTÜ MONTAJ DEMİRİ

#### Surface Mounting Iron

Ürün Kodu Product Code	Koli Adeti Quantity in Carton	Fiyat Price
131-1652	450	\$2,3

### SARKIT APARATI

#### Pendant Apparatus

Ürün Kodu Product Code	Koli Adeti Quantity in Carton	Fiyat Price
131-1656	100	\$13,70

### L DÖNÜŞ (SIVA ALTI - TAVAN)

#### L Connector

Ürün Kodu Product Code	Koli Adeti Quantity in Carton	Fiyat Price
131-1657	100	\$12,3

### L DÖNÜŞ (SIVA ÜSTÜ - TAVAN)

#### L Connector (Surface Mounted Ceiling)

Ürün Kodu Product Code	Koli Adeti Quantity in Carton	Fiyat Price
131-1654	50	\$12,3

### L DÖNÜŞ (SIVA ÜSTÜ-TAVANDAN DUVARA)

#### L Connector (Ceiling to Wall)

Ürün Kodu Product Code	Koli Adeti Quantity in Carton	Fiyat Price
131-1658	162	\$12,30

### L DONUS (SIVA ALTI- TAVANDAN DUVARA)

#### L Donus (Flush-Mounted - Ceiling To Wall)

Ürün Kodu Product Code	Koli Adeti Quantity in Carton	Fiyat Price
131-1653	162	\$12,30

### DRIVER

#### Driver

Ürün Kodu Product Code	Ürün Gücü Watt	Koli Adeti Quantity in Carton	Fiyat Price
131-1659	100W	50	\$24
131-1660	200W	25	\$36,6

### ARA BAĞLANTI KONNEKTÖRÜ

#### Interconnect Connector

Ürün Kodu Product Code	Koli Adeti Quantity in Carton	Fiyat Price
131-1655	100	\$6,2

### H TİPİ MODEL

#### H TİPİ MODEL

Ürün Kodu Product Code	Boyutlar (Metre) Dimensions	Renk Color	Koli Adeti Quantity in Carton	Fiyat Price
132-2106	1/2/3m	Siyah-Black	20	\$26,80 / m

### 12 cm KABLULU ARABAĞLANTI KONNEKTÖRÜ

#### 12 cm Wired Interconnect Connector

Ürün Kodu Product Code	Koli Adeti Quantity in Carton	Fiyat Price
131-1651	50	\$8,9

### DERİN SIVA ÜSTÜ RAY

#### DERİN SIVA ÜSTÜ RAY

Ürün Kodu Product Code	Boyutlar (Metre) Dimensions	Renk Color	Koli Adeti Quantity in Carton	Fiyat Price
132-2109	1/2/3m	Siyah-Black	20	\$23,40 / m



# LED FRAMLESS ARMATUR LED FRAMLESS ARMATURE

## Teknik Özellikler Technical Specifications

Gövde : Metal  
Body : Metal

Gövde Renkleri : Beyaz  
Body Colors : White

Difüzör : Polikarbon  
Diffuser : Polycarbonate

Renksel Geri Verim : Ra70  
Color Rendering Index : Ra70

IP Derecesi : IP20  
IP Rating : IP20

IK Derecesi : -  
IK Rating : -

Çalışma Sıcaklığı : -20°C / 40°C  
Operating Temp. Range : -20°C / 40°C



### LED FRAMLESS ARMATUR

2'si 1 arada çerçevesiz ince şık ve kullanışlı tasarım, alüminyum soğutucu taban, daha esnek ve kullanımı rahat klipsler ile hem yüzeye hem de gömme olarak monte edebilirsiniz.

### LED FRAMLESS ARMATURE

With 2 in 1 frameless slim, stylish and useful design, aluminium cooler base, more flexible and convenient to use clips, you can be mounted both on the surface and flush.

## LED FRAMLESS ARMATUR LED FRAMLESS ARMATURE

TURQUALITY®

Enerji Verimliliği Sınıfı Energy Efficiency Class	Ürün Kodu Product Code	Güç (W) Power	Renk Sıcaklığı (K) Color Temperature	Işık Akısı (Lm) Luminous Flux	Boyutlar (ØxH) mm Dimensions	Kesme Ebatı(mm) Cutting Size	Koli Adeti Quantity in Carton	Fiyat Price
A+G	BL-FA-0001	9W	3000 K	900	Ø90 x 19	55 - 80	100	\$4,50
A+G	BL-FA-0002	9W	4000 K	900	Ø90 x 19	55 - 80	100	\$4,50
A+G	BL-FA-0003	9W	6500 K	900	Ø90 x 19	55 - 80	100	\$4,50
A+G	BL-FA-0004	18W	3000 K	1620	Ø120 x 19	55 - 105	60	\$5,20
A+G	BL-FA-0005	18W	4000 K	1620	Ø120 x 19	55 - 105	60	\$5,20
A+G	BL-FA-0006	18W	6500 K	1620	Ø120 x 19	55 - 105	60	\$5,20
A+G	BL-FA-0007	24W	3000 K	2160	Ø170 x 19	55 - 160	40	\$6,70
A+G	BL-FA-0008	24W	4000 K	2160	Ø170 x 19	55 - 160	40	\$6,70
A+G	BL-FA-0009	24W	6500 K	2160	Ø170 x 19	55 - 160	40	\$6,70
A+G	BL-FA-0010	36W	3000 K	3240	Ø220 x 19	55 - 210	30	\$9,00
A+G	BL-FA-0011	36W	4000 K	3240	Ø220 x 19	55 - 210	30	\$9,00
A+G	BL-FA-0012	36W	6500 K	3240	Ø220 x 19	55 - 210	30	\$9,00

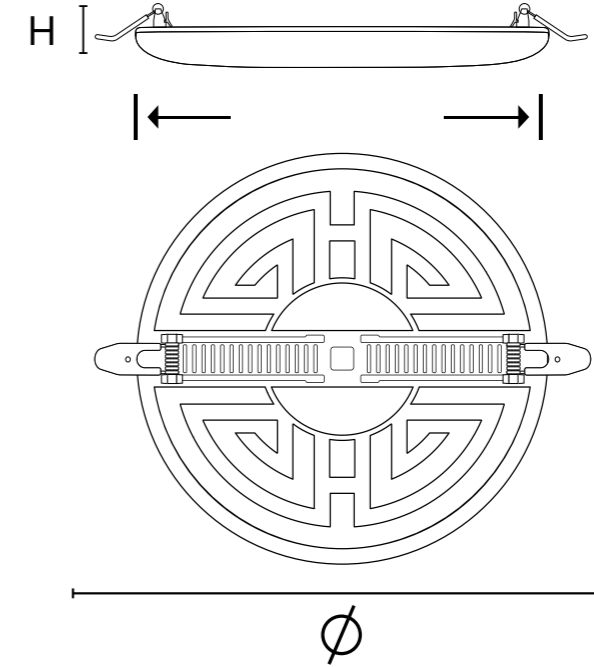

HASTANE  
HOSPITAL

borled®  
by borsan

43

Teknik veri / Datasheet

www.borled.com.tr

# LED FRAMELESS SIVA ÜSTÜ DOWNLIGHT ARMATÜR

## LED FRAMELESS SURFACE MOUNTED DOWNLIGHT ARMATURE

### Teknik Özellikler

#### Technical Specifications

Gövde : Alüminyum  
Body : Aluminium

Difüzör : Polikarbon  
Diffuser : Polycarbonate

Giriş Gerilimi : 220-240 V AC  
Input Voltage: 220-240 V AC

Renksel Geri Verim : 80  
Color Rendering Index : 80

IP Derecesi : IP20  
IP Rating : IP20

Elektriksel Koruma : Sınıf II  
Electrical Protection : Class II

Çalışma Sıcaklığı : -20°C / 45°C  
Operating Temp. Range : -20°C / 45°C



**LED FRAMELESS SIVA ÜSTÜ DOWNLIGHT ARMATÜR**  
40W Çerçevesiz LED tavan armatürünüz, yüksek performans ve parlaklığına rağmen enerji tasarrufu sağlayan verimliliği ve göz dostu aydınlatması ile büyüü bir atmosfer yaratsın.

**LED FRAMELESS SURFACE MOUNTED DOWNLIGHT ARMATURE**  
Let your 40W Frameless LED ceiling luminaire create a magical atmosphere with its energy-saving efficiency and eye-friendly lighting, despite its high performance and brightness.

# LED FRAMELESS SIVA ÜSTÜ DOWNLIGHT ARMATÜR

## LED FRAMELESS SURFACE MOUNTED DOWNLIGHT ARMATURE

Enerji Verimliliği Sınıfı Energy Efficiency Class	Ürün Kodu Product Code	Güç (W) Power	Renk Sıcaklığı (K) Color Temperature	Işık Akısı (Lm) Luminous Flux	Boyutlar (ØxH) mm Dimensions	Koli Adeti Quantity in Carton	Fiyat Price
A+ F	BL-D1-1001	40W	3000 K	4.350	220 X 40	20	\$17,60
A+ F	BL-D1-1002	40W	4000 K	4.350	220 X 40	20	\$17,60
A+ F	BL-D1-1003	40W	6500 K	4.350	220 X 40	20	\$17,60

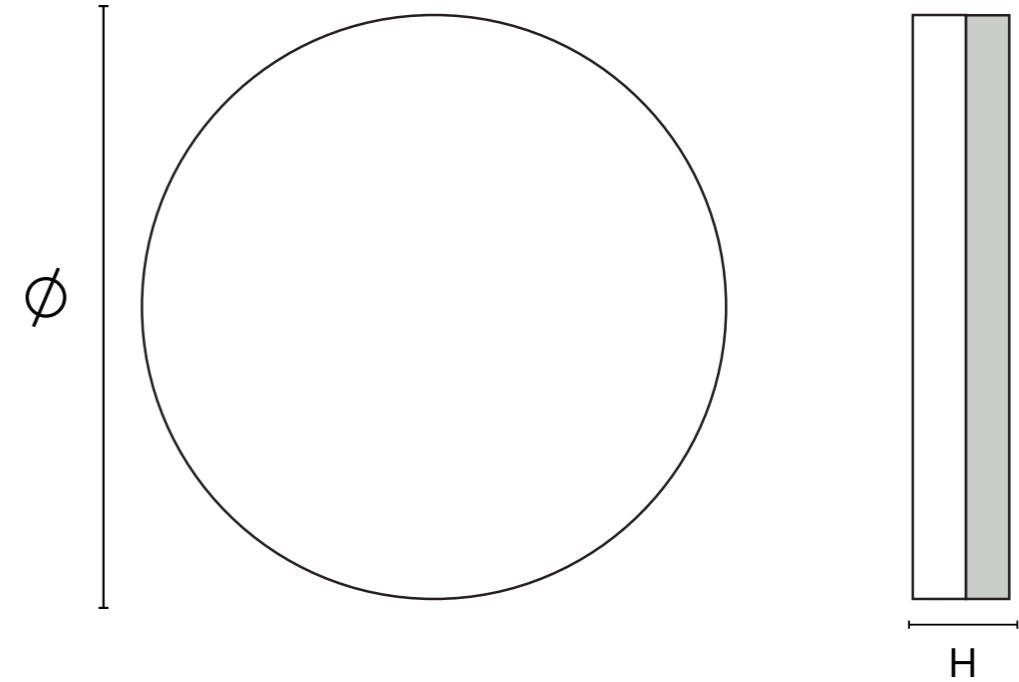

# SIVA ÜSTÜ DOWNLIGHT LED ARMATÜR

## SURFACE MOUNTED LED DOWNLIGHT

### Teknik Özellikler

#### Technical Specifications

Gövde : Alüminyum  
Body : Aluminium

Diffüzör : Polikarbon  
Diffuser : Polycarbonate

Giriş Gerilimi : 85-265 V/50-60HZ  
Input Voltage : 85-265 V/50-60HZ

Renksel Geri Verim : 80  
Color Rendering Index : 80

IP Derecesi : IP44  
IP Rating : IP44

Işık Açısı : 24°/36°/60°  
Light Angle : 24°/36°/60°

PF : >0.5  
PF : >0.5

Çalışma Sıcaklığı : -20°C / 45°C  
Operating Temp. Range : -20°C / 45°C

Flicker : Flicker Free



### SIVA ÜSTÜ DOWNLIGHT LED ARMATÜR

Siva altı ürünlerle aynı unsurların çoğuna sahiptir - temel fark, tavan veya duvarın içine yerleştirilmek yerine yüzeyine monte edilmeleridir. Her alana şık ve zarif bir aydınlatma dokunuşu eklemek için mükemmel bir seçim olan yenilikçi ve enerji tasarruflu siva üstü ürünlerimizi tercih edebilirsiniz.

### SURFACE MOUNTED LED DOWNLIGHT

They have many of the same elements as flush-mounted products - the main difference is that they are surface-mounted rather than built into the ceiling or wall. Our innovative and energy-efficient surface-mounted products are the perfect choice for adding a stylish and elegant lighting touch to any space.

# SIVA ÜSTÜ DOWNLIGHT LED ARMATÜR

## SURFACE MOUNTED LED DOWNLIGHT

Enerji Verimliliği Sınıfı Energy Efficiency Class	Ürün Kodu Product Code	Güç (W) Power	Renk Color	Renk Sıcaklığı (K) Color Temperature	Boyutlar (ØxH) mm Dimensions	Koli Adeti Quantity in Carton	Fiyat Price
A+G	BL-LS-0001	12W	Siyah-Siyah	3000 K	75 x 100	20	\$28,00
A+G	BL-LS-0002	12W	Siyah-Beyaz	3000 K	75 x 100	20	\$28,00
A+G	BL-LS-0003	12W	Siyah-Gümüş	3000 K	75 x 100	20	\$28,00
A+G	BL-LS-0004	12W	Siyah-Altın	3000 K	75 x 100	20	\$28,00
A+G	BL-LS-0005	12W	Siyah-Bronz	3000 K	75 x 100	20	\$28,00
A+G	BL-LS-0006	12W	Siyah-Siyah	4000 K	75 x 100	20	\$28,00
A+G	BL-LS-0007	12W	Siyah-Beyaz	4000 K	75 x 100	20	\$28,00
A+G	BL-LS-0008	12W	Siyah-Gümüş	4000 K	75 x 100	20	\$28,00
A+G	BL-LS-0009	12W	Siyah-Altın	4000 K	75 x 100	20	\$28,00
A+G	BL-LS-0010	12W	Siyah-Bronz	4000 K	75 x 100	20	\$28,00
A+G	BL-LS-0011	12W	Siyah-Siyah	6500 K	75 x 100	20	\$28,00
A+G	BL-LS-0012	12W	Siyah-Beyaz	6500 K	75 x 100	20	\$28,00
A+G	BL-LS-0013	12W	Siyah-Gümüş	6500 K	75 x 100	20	\$28,00
A+G	BL-LS-0014	12W	Siyah-Altın	6500 K	75 x 100	20	\$28,00
A+G	BL-LS-0015	12W	Siyah-Bronz	6500 K	75 x 100	20	\$28,00
A+G	BL-LS-0046	12W	Beyaz-Siyah	3000 K	75 x 100	20	\$28,00
A+G	BL-LS-0047	12W	Beyaz-Beyaz	3000 K	75 x 100	20	\$28,00
A+G	BL-LS-0048	12W	Beyaz-Gümüş	3000 K	75 x 100	20	\$28,00
A+G	BL-LS-0049	12W	Beyaz-Altın	3000 K	75 x 100	20	\$28,00
A+G	BL-LS-0050	12W	Beyaz-Bronz	3000 K	75 x 100	20	\$28,00
A+G	BL-LS-0051	12W	Beyaz-Siyah	4000 K	75 x 100	20	\$28,00
A+G	BL-LS-0052	12W	Beyaz-Beyaz	4000 K	75 x 100	20	\$28,00
A+G	BL-LS-0053	12W	Beyaz-Gümüş	4000 K	75 x 100	20	\$28,00
A+G	BL-LS-0054	12W	Beyaz-Altın	4000 K	75 x 100	20	\$28,00





# SIVA ÜSTÜ DOWNLIGHT LED ARMATÜR

## SURFACE MOUNTED LED DOWNLIGHT

### Teknik Özellikler

#### Technical Specifications

Gövde : Alüminyum  
Body : Aluminium

Difüzör : Polikarbon  
Diffuser : Polycarbonate

Giriş Gerilimi : 85-265 V/50-60HZ  
Input Voltage : 85-265 V/50-60HZ

Renksel Geri Verim : 80  
Color Rendering Index : 80

IP Derecesi : IP44  
IP Rating : IP44

Işık Açısı : 24°/36°/60°  
Light Angle : 24°/36°/60°

PF : >0.5  
PF : >0.5

Çalışma Sıcaklığı : -20°C / 45°C  
Operating Temp. Range : -20°C / 45°C

Flicker : Flicker Free



### SIVA ÜSTÜ DOWNLIGHT LED ARMATÜR

Siva altı ürünlerle aynı unsurların çoğuna sahiptir - temel fark, tavan veya duvarın içine yerleştirilmek yerine yüzeyine monte edilmeleridir. Her alana şık ve zarif bir aydınlatma dokunuşu eklemek için mükemmel bir seçim olan yenilikçi ve enerji tasarruflu siva üstü ürünlerimizi tercih edebilirsiniz.

### SURFACE MOUNTED LED DOWNLIGHT

They have many of the same elements as flush-mounted products - the main difference is that they are surface-mounted rather than built into the ceiling or wall. Our innovative and energy-efficient surface-mounted products are the perfect choice for adding a stylish and elegant lighting touch to any space.

# SIVA ÜSTÜ DOWNLIGHT LED ARMATÜR

## SURFACE MOUNTED LED DOWNLIGHT

Enerji Verimliliği Sınıfı Energy Efficiency Class	Ürün Kodu Product Code	Güç (W) Power	Renk Color	Renk Sıcaklığı (K) Color Temperature	Boyutlar (ØxH) mm Dimensions	Koli Adeti Quantity in Carton	Fiyat Price
A+G	BL-LS-0055	12W	Beyaz-Bronz	4000 K	75 x 100	20	\$28,00
A+G	BL-LS-0056	12W	Beyaz - Siyah	6500 K	75 x 100	20	\$28,00
A+G	BL-LS-0057	12W	Beyaz-Beyaz	6500 K	75 x 100	20	\$28,00
A+G	BL-LS-0058	12W	Beyaz-Gümüş	6500 K	75 x 100	20	\$28,00
A+G	BL-LS-0059	12W	Beyaz-Altın	6500 K	75 x 100	20	\$28,00
A+G	BL-LS-0060	12W	Beyaz-Bronz	6500 K	75 x 100	20	\$28,00
A+G	BL-LS-0016	18W	Siyah-Siyah	3000 K	95 x 110	20	\$40,00
A+G	BL-LS-0017	18W	Siyah-Beyaz	3000 K	95 x 110	20	\$40,00
A+G	BL-LS-0018	18W	Siyah-Gümüş	3000 K	95 x 110	20	\$40,00
A+G	BL-LS-0019	18W	Siyah-Altın	3000 K	95 x 110	20	\$40,00
A+G	BL-LS-0020	18W	Siyah-Bronz	3000 K	95 x 110	20	\$40,00
A+G	BL-LS-0021	18W	Siyah-Siyah	4000 K	95 x 110	20	\$40,00
A+G	BL-LS-0022	18W	Siyah-Beyaz	4000 K	95 x 110	20	\$40,00
A+G	BL-LS-0023	18W	Siyah-Gümüş	4000 K	95 x 110	20	\$40,00
A+G	BL-LS-0024	18W	Siyah-Altın	4000 K	95 x 110	20	\$40,00
A+G	BL-LS-0025	18W	Siyah-Bronz	4000 K	95 x 110	20	\$40,00
A+G	BL-LS-0026	18W	Siyah-Siyah	6500 K	95 x 110	20	\$40,00
A+G	BL-LS-0027	18W	Siyah-Beyaz	6500 K	95 x 110	20	\$40,00
A+G	BL-LS-0028	18W	Siyah-Gümüş	6500 K	95 x 110	20	\$40,00
A+G	BL-LS-0029	18W	Siyah-Altın	6500 K	95 x 110	20	\$40,00
A+G	BL-LS-0030	18W	Siyah-Bronz	6500 K	95 x 110	20	\$40,00
A+G	BL-LS-0061	18W	Beyaz-Siyah	3000 K	95 x 110	20	\$40,00



# SIVA ÜSTÜ DOWNLIGHT LED ARMATÜR SURFACE MOUNTED LED DOWNLIGHT

## Teknik Özellikler Technical Specifications

Gövde : Alüminyum  
Body : Aluminium

Diffüzör : Polikarbon  
Diffuser : Polycarbonate

Giriş Gerilimi : 85-265 V/50-60HZ  
Input Voltage : 85-265 V/50-60HZ

Renksel Geri Verim : 80  
Color Rendering Index : 80

IP Derecesi : IP44  
IP Rating : IP44

Işık Açısı : 24°/36°/60°  
Light Angle : 24°/36°/60°

PF : >0.5  
PF : >0.5

Çalışma Sıcaklığı : -20°C / 45°C  
Operating Temp. Range : -20°C / 45°C

Flicker : Flicker Free



## SIVA ÜSTÜ DOWNLIGHT LED ARMATÜR

Siva altı ürünlerle aynı unsurların çoğuna sahiptir - temel fark, tavan veya duvarın içine yerleştirilmek yerine yüzeyine monte edilmeleridir. Her alana şık ve zarif bir aydınlatma dokunuşu eklemek için mükemmel bir seçim olan yenilikçi ve enerji tasarruflu siva üstü ürünlerimizi tercih edebilirsiniz.

## SURFACE MOUNTED LED DOWNLIGHT

They have many of the same elements as flush-mounted products - the main difference is that they are surface-mounted rather than built into the ceiling or wall. Our innovative and energy-efficient surface-mounted products are the perfect choice for adding a stylish and elegant lighting touch to any space.

# SIVA ÜSTÜ DOWNLIGHT LED ARMATÜR SURFACE MOUNTED LED DOWNLIGHT

TURQUALITY®

Enerji Verimliliği Sınıfı Energy Efficiency Class	Ürün Kodu Product Code	Güç (W) Power	Renk Color	Renk Sıcaklığı (K) Color Temperature	Boyutlar (ØxH) mm Dimensions	Koli Adeti Quantity in Carton	Fiyat Price	
A T G	F	BL-LS-0062	18W	Beyaz-Beyaz	3000 K	95 x 110	20	\$40,00
A T G	F	BL-LS-0063	18W	Beyaz-Gümüş	3000 K	95 x 110	20	\$40,00
A T G	F	BL-LS-0064	18W	Beyaz-Altın	3000 K	95 x 110	20	\$40,00
A T G	F	BL-LS-0065	18W	Beyaz-Bronz	3000 K	95 x 110	20	\$40,00
A T G	F	BL-LS-0066	18W	Beyaz-Siyah	4000 K	95 x 110	20	\$40,00
A T G	F	BL-LS-0067	18W	Beyaz-Beyaz	4000 K	95 x 110	20	\$40,00
A T G	F	BL-LS-0068	18W	Beyaz-Gümüş	4000 K	95 x 110	20	\$40,00
A T G	F	BL-LS-0069	18W	Beyaz-Altın	4000 K	95 x 110	20	\$40,00
A T G	F	BL-LS-0070	18W	Beyaz-Bronz	4000 K	95 x 110	20	\$40,00
A T G	F	BL-LS-0071	18W	Beyaz - Siyah	6500 K	95 x 110	20	\$40,00
A T G	F	BL-LS-0072	18W	Beyaz-Beyaz	6500 K	95 x 110	20	\$40,00
A T G	F	BL-LS-0073	18W	Beyaz-Gümüş	6500 K	95 x 110	20	\$40,00
A T G	F	BL-LS-0074	18W	Beyaz-Altın	6500 K	95 x 110	20	\$40,00
A T G	F	BL-LS-0075	18W	Beyaz-Bronz	6500 K	95 x 110	20	\$40,00
A T G	F	BL-LS-0031	24W	Siyah-Siyah	3000 K	110 x 130	20	\$50,50
A T G	F	BL-LS-0032	24W	Siyah-Beyaz	3000 K	110 x 130	20	\$50,50
A T G	F	BL-LS-0033	24W	Siyah-Gümüş	3000 K	110 x 130	20	\$50,50
A T G	F	BL-LS-0034	24W	Siyah-Altın	3000 K	110 x 130	20	\$50,50
A T G	F	BL-LS-0035	24W	Siyah-Bronz	3000 K	110 x 130	20	\$50,50
A T G	F	BL-LS-0036	24W	Siyah-Siyah	4000 K	110 x 130	20	\$50,50
A T G	F	BL-LS-0037	24W	Siyah-Beyaz	4000 K	110 x 130	20	\$50,50
A T G	F	BL-LS-0038	24W	Siyah-Gümüş	4000 K	110 x 130	20	\$50,50



# SIVA ÜSTÜ DOWNLIGHT LED ARMATÜR SURFACE MOUNTED LED DOWNLIGHT

## Teknik Özellikler Technical Specifications

Gövde : Alüminyum  
Body : Aluminium

Diffüzör : Polikarbon  
Diffuser : Polycarbonate

Giriş Gerilimi : 85-265 V/50-60HZ  
Input Voltage : 85-265 V/50-60HZ

Renksel Geri Verim : 80  
Color Rendering Index : 80

IP Derecesi : IP44  
IP Rating : IP44

Işık Açısı : 24°/36°/60°  
Light Angle : 24°/36°/60°

PF : >0.5  
PF : >0.5

Çalışma Sıcaklığı : -20°C / 45°C  
Operating Temp. Range : -20°C / 45°C

Flicker : Flicker Free



## SIVA ÜSTÜ DOWNLIGHT LED ARMATÜR

Siva altı ürünlerle aynı unsurların çoğuna sahiptir - temel fark, tavan veya duvarın içine yerleştirilmek yerine yüzeyine monte edilmeleridir. Her alana şık ve zarif bir aydınlatma dokunuşu eklemek için mükemmel bir seçim olan yenilikçi ve enerji tasarruflu siva üstü ürünlerimizi tercih edebilirsiniz.

## SURFACE MOUNTED LED DOWNLIGHT

They have many of the same elements as flush-mounted products - the main difference is that they are surface-mounted rather than built into the ceiling or wall. Our innovative and energy-efficient surface-mounted products are the perfect choice for adding a stylish and elegant lighting touch to any space.

# SIVA ÜSTÜ DOWNLIGHT LED ARMATÜR SURFACE MOUNTED LED DOWNLIGHT

TURQUALITY®

Enerji Verimliliği Sınıfı Energy Efficiency Class	Ürün Kodu Product Code	Güç (W) Power	Renk Color	Renk Sıcaklığı (K) Color Temperature	Boyutlar (ØxH) mm Dimensions	Koli Adeti Quantity in Carton	Fiyat Price	
A T G	F	BL-LS-0039	24W	Siyah-Altın	4000 K	110 x 130	20	\$50,50
A T G	F	BL-LS-0040	24W	Siyah-Bronz	4000 K	110 x 130	20	\$50,50
A T G	F	BL-LS-0041	24W	Siyah-Siyah	6500 K	110 x 130	20	\$50,50
A T G	F	BL-LS-0042	24W	Siyah-Beyaz	6500 K	110 x 130	20	\$50,50
A T G	F	BL-LS-0043	24W	Siyah-Gümüş	6500 K	110 x 130	20	\$50,50
A T G	F	BL-LS-0044	24W	Siyah-Altın	6500 K	110 x 130	20	\$50,50
A T G	F	BL-LS-0045	24W	Siyah-Bronz	6500 K	110 x 130	20	\$50,50
A T G	F	BL-LS-0076	24W	Beyaz-Siyah	3000 K	110 x 130	20	\$50,50
A T G	F	BL-LS-0077	24W	Beyaz-Beyaz	3000 K	110 x 130	20	\$50,50
A T G	F	BL-LS-0078	24W	Beyaz-Gümüş	3000 K	110 x 130	20	\$50,50
A T G	F	BL-LS-0079	24W	Beyaz-Altın	3000 K	110 x 130	20	\$50,50
A T G	F	BL-LS-0080	24W	Beyaz-Bronz	3000 K	110 x 130	20	\$50,50
A T G	F	BL-LS-0081	24W	Beyaz-Siyah	4000 K	110 x 130	20	\$50,50
A T G	F	BL-LS-0082	24W	Beyaz-Beyaz	4000 K	110 x 130	20	\$50,50
A T G	F	BL-LS-0083	24W	Beyaz-Gümüş	4000 K	110 x 130	20	\$50,50
A T G	F	BL-LS-0084	24W	Beyaz-Altın	4000 K	110 x 130	20	\$50,50
A T G	F	BL-LS-0085	24W	Beyaz-Bronz	4000 K	110 x 130	20	\$50,50
A T G	F	BL-LS-0086	24W	Beyaz - Siyah	6500 K	110 x 130	20	\$50,50
A T G	F	BL-LS-0087	24W	Beyaz-Beyaz	6500 K	110 x 130	20	\$50,50
A T G	F	BL-LS-0088	24W	Beyaz-Gümüş	6500 K	110 x 130	20	\$50,50
A T G	F	BL-LS-0089	24W	Beyaz-Altın	6500 K	110 x 130	20	\$50,50
A T G	F	BL-LS-0090	24W	Beyaz-Bronz	6500 K	110 x 130	20	\$50,50



# SLIM LED PANEL ARMATÜR

## SLIM LED PANEL ARMATURE

### Teknik Özellikler

#### Technical Specifications

Gövde : Alüminyum  
Body : Aluminium

Gövde Renkleri : Beyaz  
Body Colors : White

Difüzör : PMMA  
Diffuser : PMMA

Renksel Geri Verim : 80  
Color Rendering Index : 80

IK Derecesi : IK03  
IK Rating : IK03

Elektriksel Koruma : Sınıf II  
Electrical Protection : Class II

Çalışma Sıcaklığı : -20°C / 45°C  
Operating Tem. Range : -20°C / 45°C



### SLIM LED PANEL ARMATÜR

Önemli ölçüde enerji ve bakım tasarrufu sağlayan yüksek performanslı düz panel armatürdür. Şık minimalist tasarıma sahip ince led panellerimiz, azaltılmış enerji tüketimi ile geleneksel floresan tipi aydınlatma çözümlerine eşdeğerdir. Uygun maliyetli, ince bir aydınlatma hattı gerektiren ofis, sağlık, eğitim, otel, restoran, alışveriş merkezi ve ticari alanlar gibi geniş bir uygulama yelpazesi için uygundur.

### SLIM LED PANEL ARMATURE

It is a high-performance flat panel luminaire that provides significant energy and maintenance savings. Our slim led panels with stylish minimalist design are equivalent to traditional fluorescent type lighting solutions with reduced energy consumption. It is suitable for a wide range of applications such as office, health, education, hotel, restaurant, shopping mall and commercial areas that require a cost-effective, thin line of lighting.

### 60X60 SLIM LED PANEL ARMATÜR

#### 60X60 SLIM LED PANEL ARMATURE

Enerji Verimliliği Sınıfı Energy Efficiency Class	Ürün Kodu Product Code	Güç (W) Power	Renk Sıcaklığı (K) Color Temperature	Işık Akısı (Lm) Luminous Flux	Boyutlar (WxLxH) mm Dimensions	Kesme Ebatı(mm) Cutting Size	Koli Adeti Quantity in Carton	Fiyat Price
A+G F	BL-O5-2001	40W	3000 K	3600	595 × 595 × 7.5	580 × 580	12	\$44,20
A+G F	BL-O5-2002	40W	4000 K	3600	595 × 595 × 7.5	580 × 580	12	\$44,20
A+G F	BL-O5-2003	40W	6500 K	3600	595 × 595 × 7.5	580 × 580	12	\$44,20

### 30X30 SLIM LED PANEL ARMATÜR

#### 30X30 SLIM LED PANEL ARMATURE

Enerji Verimliliği Sınıfı Energy Efficiency Class	Ürün Kodu Product Code	Güç (W) Power	Renk Sıcaklığı (K) Color Temperature	Işık Akısı (Lm) Luminous Flux	Boyutlar (WxLxH) mm Dimensions	Kesme Ebatı(mm) Cutting Size	Koli Adeti Quantity in Carton	Fiyat Price
A+G G	BL-O8-0001	24W	3000 K	1600	295 × 295 × 7.5	270 × 270	12	\$30,30
A+G G	BL-O8-0002	24W	4000 K	1600	295 × 295 × 7.5	270 × 270	12	\$30,30
A+G G	BL-O8-0003	24W	6500 K	1600	295 × 295 × 7.5	270 × 270	12	\$30,30

### 30X60 SLIM LED PANEL ARMATÜR

#### 30X60 SLIM LED PANEL ARMATURE

Enerji Verimliliği Sınıfı Energy Efficiency Class	Ürün Kodu Product Code	Güç (W) Power	Renk Sıcaklığı (K) Color Temperature	Işık Akısı (Lm) Luminous Flux	Boyutlar (WxLxH) mm Dimensions	Kesme Ebatı(mm) Cutting Size	Koli Adeti Quantity in Carton	Fiyat Price
A+G G	BL-O6-2001	24W	3000 K	1600	295 × 595 × 7.5	270 × 580	12	\$38,50
A+G G	BL-O6-2002	24W	4000 K	1600	295 × 595 × 7.5	270 × 580	12	\$38,50
A+G G	BL-O6-2003	24W	6500 K	1600	295 × 595 × 7.5	270 × 580	12	\$38,50

### 30X120 SLIM LED PANEL ARMATÜR

#### 30X120 SLIM LED PANEL ARMATURE

Enerji Verimliliği Sınıfı Energy Efficiency Class	Ürün Kodu Product Code	Güç (W) Power	Renk Sıcaklığı (K) Color Temperature	Işık Akısı (Lm) Luminous Flux	Boyutlar (WxLxH) mm Dimensions	Kesme Ebatı(mm) Cutting Size	Koli Adeti Quantity in Carton	Fiyat Price
A+G G	BL-O7-2001	48W	3000 K	3200	295 × 1195 x 7.5	270 × 1180	12	\$79,50
A+G G	BL-O7-2002	48W	4000 K	3200	295 × 1195 x 7.5	270 × 1180	12	\$79,50
A+G G	BL-O7-2003	48W	6500 K	3200	295 × 1195 x 7.5	270 × 1180	12	\$79,50

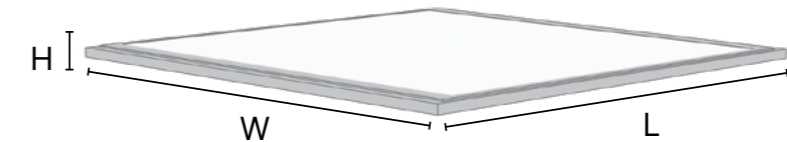

Teknik veri / Datasheet

www.borled.com.tr

## LED OPAL LENSİ SLIM BACKLIGHT ARMATÜR LED SLIM BACKLIGHT ARMATURE - OPAL LENS

### Teknik Özellikler Technical Specifications

Gövde : DKP Sac  
Body : DKP Metal Sheet

Gövde Renkleri : Beyaz  
Body Colors : White

Difüzör : PMMA  
Diffuser : PMMA

Renksel Geri Verim : 80  
Color Rendering Index : 80

IP Derecesi : IP20  
IP Rating : IP20

IK Derecesi : IK02  
IK Rating : IK02

Elektriksel Koruma : Sınıf II  
Electrical Protection : Class II

Çalışma Sıcaklığı : -20°C / 45°C  
Operating Temp.Range : -20°C / 45°C

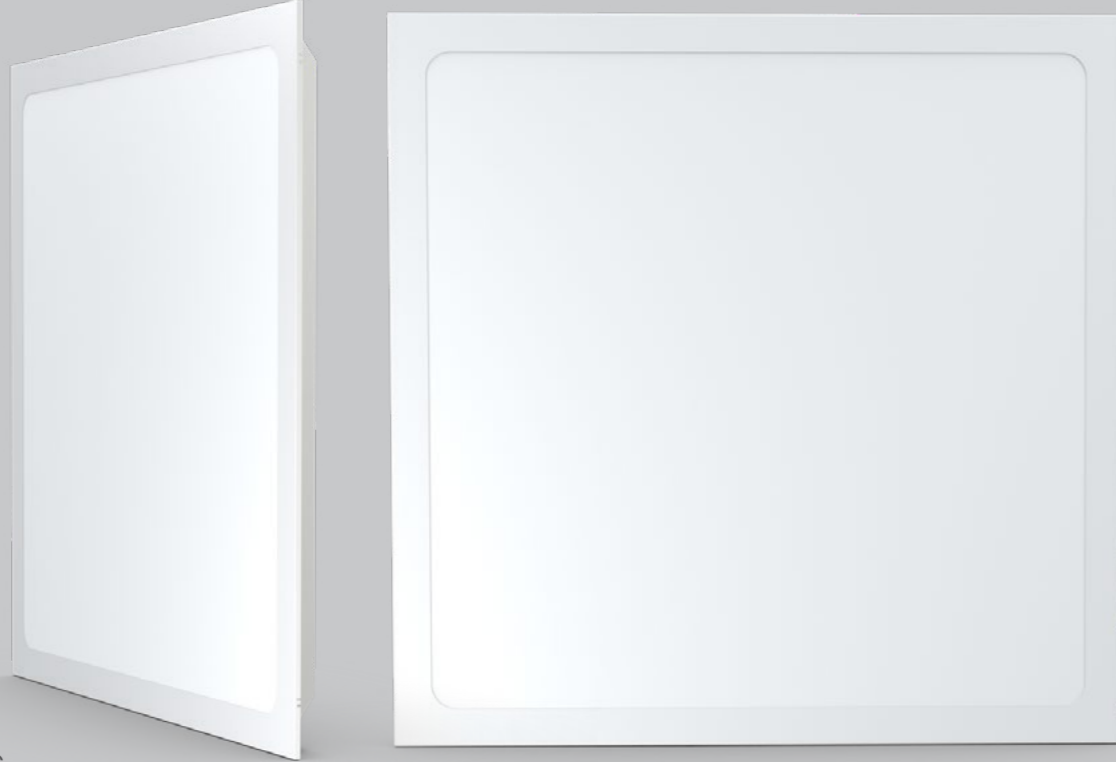

### LED OPAL LENSİ SLIM BACKLIGHT ARMATÜR

Alçıpan tavan çeşitleri ile uyumlu gövde yapısı, tüm iç mekanların genel aydınlatma ihtiyacını karşılamak için idealdir. Optimum ışık geçirgenliğine ve homojen yayılmaya sahip, sararma ve renk değiştirmeyen opal lens difüzörü ile fark yaratır.

### LED SLIM BACKLIGHT ARMATURE - OPAL LENS

The body structure compatible with plasterboard ceiling types is ideal for meeting the general lighting needs of all interior spaces. It makes a difference with its opal lens diffuser, which has an optimum light transmission and homogeneous spread, which does not turn yellow or change colour.

## LED OPAL LENSİ SLIM BACKLIGHT ARMATÜR LED SLIM BACKLIGHT ARMATURE - OPAL LENS

Enerji Verimliliği Sınıfı Energy Efficiency Class	Ürün Kodu Product Code	Güç (W) Power	Renk Sıcaklığı (K) Color Temperature	Işık Akısı (Lm) Luminous Flux	Boyutlar (WxLxH) mm Dimensions	Koli Adeti Quantity in Carton	Fiyat Price
A T G F	BL-O2-3008	15W	3000 K	1350	295 × 295 × 35	12	\$21,70
A T G F	BL-O2-3009	15W	4000 K	1350	296 × 295 × 35	12	\$21,70
A T G F	BL-O2-3010	15W	6500 K	1350	297 × 295 × 35	12	\$21,70
A T G F	BL-O2-2011	40W	3000 K	3600	595 × 595 × 35	6	\$29,60
A T G F	BL-O2-2012	40W	4000 K	3600	595 × 595 × 35	6	\$29,60
A T G F	BL-O2-2013	40W	6500 K	3600	595 × 595 × 35	6	\$29,60

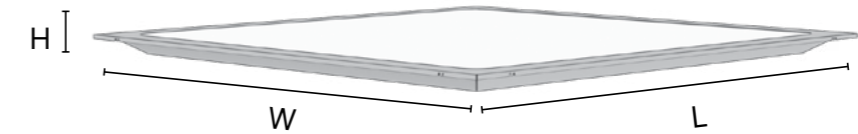

# LED OPAL LENSİ SLIM BACKLIGHT ARMATÜR TSE

## LED SLIM BACKLIGHT ARMATURE - OPAL LENS TSE

### Teknik Özellikler

#### Technical Specifications

Gövde : DKP Sac  
Body : DKP Metal Sheet

Gövde Renkleri : Beyaz  
Body Colors : White

Difüzör : PMMA  
Diffuser : PMMA

Renksel Geri Verim : 80  
Color Rendering Index : 80

IP Derecesi : IP20  
IP Rating : IP20

IK Derecesi : IK02  
IK Rating : IK02

Elektriksel Koruma : Sınıf II  
Electrical Protection : Class II

Çalışma Sıcaklığı : -20°C / 45°C  
Operating Temp.Range : -20°C / 45°C

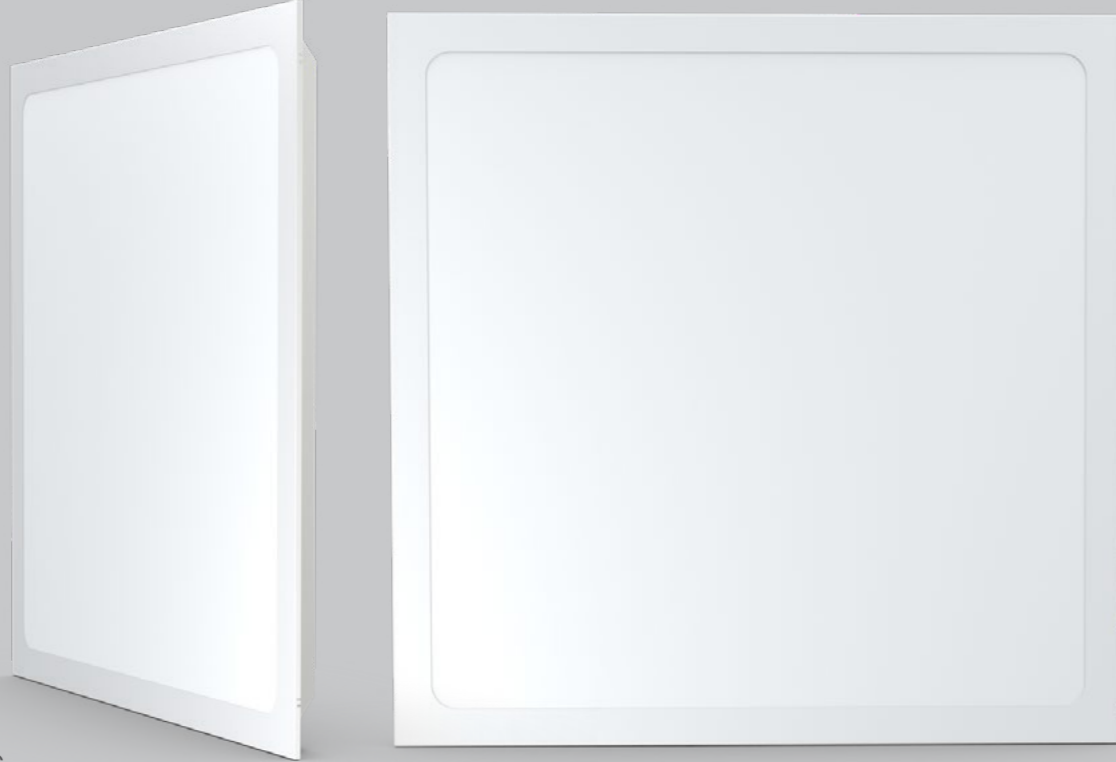

### LED OPAL LENSİ SLIM BACKLIGHT ARMATÜR

Alçıpan tavan çeşitleri ile uyumlu gövde yapısı, tüm iç mekanların genel aydınlatma ihtiyacını karşılamak için idealdir. Optimum ışık geçirgenliğine ve homojen yayılmaya sahip, sararma ve renk değiştirmeyen opal lens difüzörü ile fark yaratır.

### LED SLIM BACKLIGHT ARMATURE - OPAL LENS

The body structure compatible with plasterboard ceiling types is ideal for meeting the general lighting needs of all interior spaces. It makes a difference with its opal lens diffuser, which has an optimum light transmission and homogeneous spread, which does not turn yellow or change colour.

# LED OPAL LENSİ SLIM BACKLIGHT ARMATÜR TSE

## LED SLIM BACKLIGHT ARMATURE - OPAL LENS TSE

Enerji Verimliliği Sınıfı Energy Efficiency Class	Ürün Kodu Product Code	Güç (W) Power	Renk Sıcaklığı (K) Color Temperature	Işık Akısı (Lm) Luminous Flux	Boyutlar (WxLxH) mm Dimensions	Koli Adeti Quantity in Carton	Fiyat Price
A+ F	BLT-O2-3008	15W	3000 K	1350	295 × 295 × 35	12	\$27.00
A+ F	BLT-O2-3009	15W	4000 K	1350	296 × 295 × 35	12	\$27.00
A+ F	BLT-O2-3010	15W	6500 K	1350	297 × 295 × 35	12	\$27.00
A+ F	BLT-O2-2011	40W	3000 K	3600	595 × 595 × 35	6	\$38.50
A+ F	BLT-O2-2012	40W	4000 K	3600	595 × 595 × 35	6	\$38.50
A+ F	BLT-O2-2013	40W	6500 K	3600	595 × 595 × 35	6	\$38.50

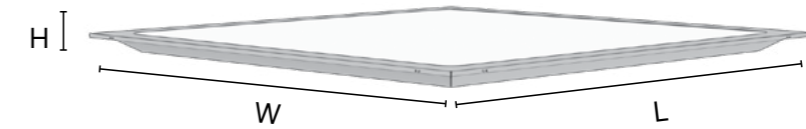

Teknik veri / Datasheet

www.borled.com.tr

# LED OPAL LENSİ BACKLIGHT ARMATÜR

## LED BACKLIGHT ARMATURE - OPAL LENS

### Teknik Özellikler

#### Technical Specifications

Gövde : DKP Sac  
Body : DKP Metal Sheet

Gövde Renkleri : Beyaz  
Body Colors : White

Difüzör : Akrilik (PMMA)  
Diffuser : Acrylic (PMMA)

Sürücü : Eaglerise/Osram/Tridonic  
Driver : Eaglerise/Osram/Tridonic

Renksel Geri Verim : 80  
Color Rendering Index : 80

IP Derecesi : IP20  
IP Rating : IP20

IK Derecesi : IK03  
IK Rating : IK03

Elektriksel Koruma : Sınıf I  
Electrical Protection : Class I

Çalışma Sıcaklığı : -20°C / 45°C  
Operating Temp. Range : -20°C / 45°C

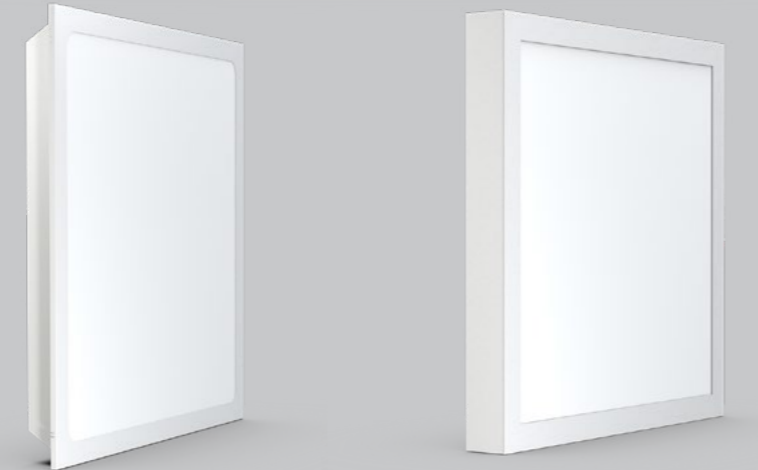
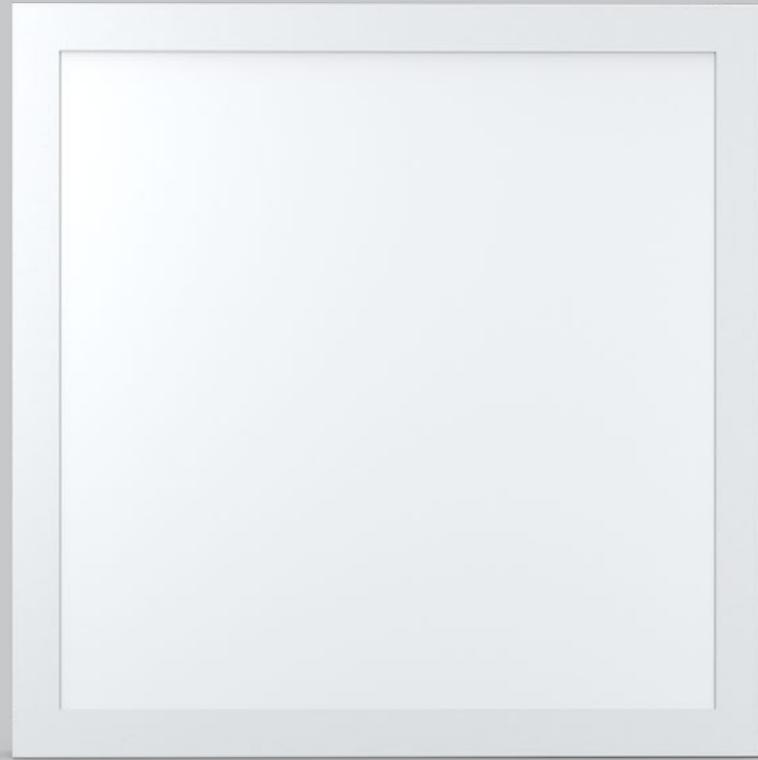

### LED OPAL LENSİ BACKLIGHT ARMATÜR

Alçıpan tavan çeşitleri ile uyumlu gövde yapısı ve harici siva üstü çerçeveler sayesinde tüm iç mekanların genel aydınlatma ihtiyacını karşılamak için idealdir. Optimum ışık geçirgenliğine ve homojen yayılmaya sahip, sararma ve renk değiştirmeyen opal lens difüzörü ile fark yaratır.

### LED BACKLIGHT ARMATURE - OPAL LENS

It is ideal for meeting the general lighting needs of all interior spaces thanks to its body structure compatible with plasterboard ceiling types and external surface-mounted frames. It makes a difference with its opal lens diffuser, which has optimum light transmittance and homogeneous spread that does not turn yellow and does not change colour.

## LED OPAL LENSİ BACKLIGHT SIVA ALTI ARMATÜR

### LED FLUSH MOUNTED BACKLIGHT ARMATURE - OPAL LENS

Enerji Verimliliği Sınıfı Energy Efficiency Class	Ürün Kodu Product Code	Güç (W) Power	Renk Sıcaklığı (K) Color Temperature	Işık Akısı (Lm) Luminous Flux	Boyutlar (WxLxH) mm Dimensions	Koli Adeti Quantity in Carton	Fiyat Price
A++	BLT-O2-2005	12W	4000 K	1575	300 × 300 × 65	8	\$56,60
A++	BLT-O2-2006	12W	6500 K	1575	300 × 300 × 65	8	\$56,60
A++	BLT-O6-0002	24W	4000 K	2750	300 × 600 × 65	4	\$90,10
A++	BLT-O6-0003	24W	6500 K	2750	300 × 600 × 65	4	\$90,10
A++	BLT-O2-2002	36W	4000 K	4500	600 × 600 × 65	2	\$109,50
A++	BLT-O2-2003	36W	6500 K	4500	600 × 600 × 65	2	\$109,50

## LED OPAL LENSİ BACKLIGHT SIVA ÜSTÜ ARMATÜR

### LED SURFACE MOUNTED BACKLIGHT ARMATURE - OPAL LENS

Enerji Verimliliği Sınıfı Energy Efficiency Class	Ürün Kodu Product Code	Güç (W) Power	Renk Sıcaklığı (K) Color Temperature	Işık Akısı (Lm) Luminous Flux	Boyutlar (WxLxH) mm Dimensions	Koli Adeti Quantity in Carton	Fiyat Price
A++	BLT-O5-2005	12W	4000 K	1575	300 × 300 × 65	8	\$71,40
A++	BLT-O5-2006	12W	6500 K	1575	300 × 300 × 65	8	\$71,40
A++	BLT-O6-1002	24W	4000 K	2750	300 × 600 × 65	4	\$122,00
A++	BLT-O6-1003	24W	6500 K	2750	300 × 600 × 65	4	\$122,00
A++	BLT-O5-2008	36W	4000 K	4500	600 × 600 × 65	2	\$115,20
A++	BLT-O5-2009	36W	6500 K	4500	600 × 600 × 65	2	\$115,20

## LED OPAL LENSİ BACKLIGHT CLIP-IN ARMATÜR

### LED BACKLIGHT CLIP-IN ARMATURE - OPAL LENS

Enerji Verimliliği Sınıfı Energy Efficiency Class	Ürün Kodu Product Code	Güç (W) Power	Renk Sıcaklığı (K) Color Temperature	Işık Akısı (Lm) Luminous Flux	Boyutlar (WxLxH) mm Dimensions	Koli Adeti Quantity in Carton	Fiyat Price
A++	BLT-O2-3011	20W	4000 K	2000	300 × 300 × 65	8	\$31,70
A++	BLT-O2-3012	20W	6500 K	2000	300 × 300 × 65	8	\$31,70
A++	BLT-O6-2002	24W	4000 K	2750	300 × 600 × 65	4	\$122,00
A++	BLT-O6-2003	24W	6500 K	2750	300 × 600 × 65	4	\$122,00
A++	BLT-O2-2008	36W	4000 K	4500	600 × 600 × 65	2	\$83,30
A++	BLT-O2-2009	36W	6500 K	4500	600 × 600 × 65	2	\$83,30

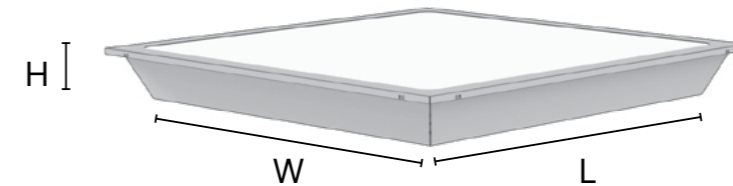

Teknik veri / Datasheet

www.borled.com.tr

## LED BACKLIGHT STERIL ORTAM ARMATÜR LED BACKLIGHT STERILE AMBIENT ARMATURE

### Teknik Özellikler Technical Specifications

Gövde : DKP Sac  
Body : DKP Metal Sheet

Gövde Renkleri : Beyaz  
Body Colors : White

Difüzör : Temperli Cam  
Diffuser : Tempered Glass

Renksel Geri Verim : 80  
Color Rendering Index : 80

IP Derecesi : IP65  
IP Rating : IP65

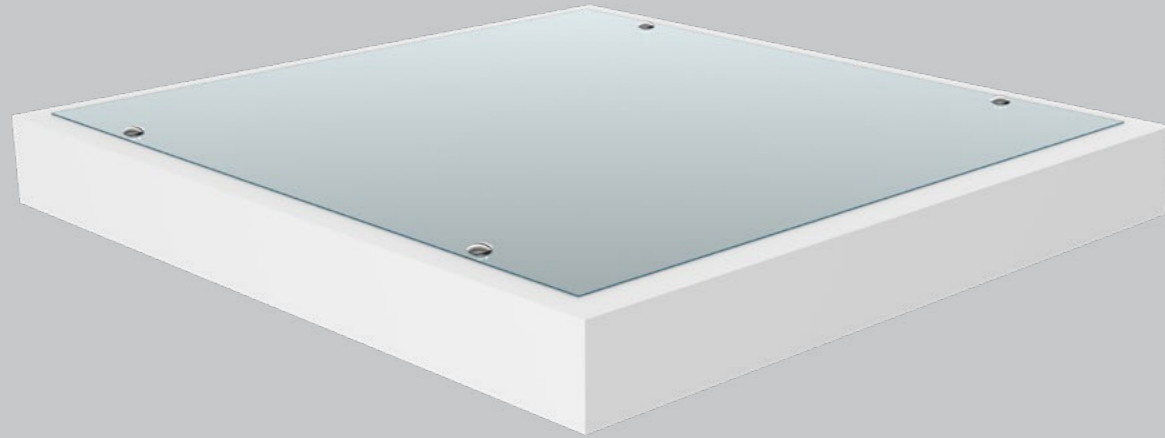
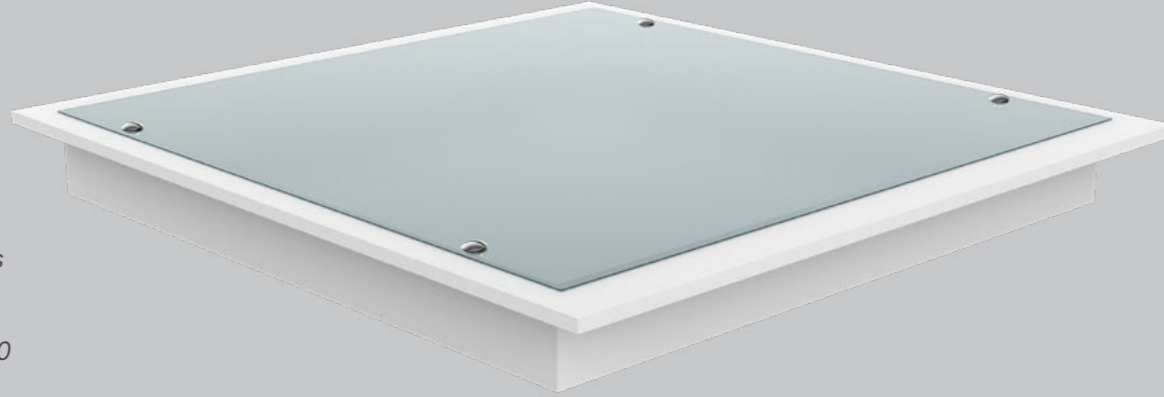

#### LED BACKLIGHT STERIL ORTAM ARMATÜR

Temperli cam çerçevesi ile bireysel ve homojen aydınlatma sağlayan steril ortam armatürüdür. Verimli ve hijyen aydınlatma gerektiren tüm iç mekanlar, hastaneler, laboratuvarlar, klinikler, eczaneler, temiz odalar, gıda hazırlama alanları gibi yerler için idealdir.

#### LED BACKLIGHT STERILE AMBIENT ARMATURE

It is a sterile environment luminaire that provides individual and homogeneous lighting with its tempered glass frame. All interior spaces require efficient and hygienic lighting. Ideal for hospitals, laboratories, clinics, pharmacies, clean rooms, food preparation areas.

## LED BACKLIGHT STERIL ORTAM SIVA ALTI ARMATÜR LED BACKLIGHT STERILE AMBIENT ARMATURE

Enerji Verimliliği Sınıfı Energy Efficiency Class	Ürün Kodu Product Code	Güç (W) Power	Renk Sıcaklığı (K) Color Temperature	Işık Akısı (Lm) Luminous Flux	Boyutlar (WxLxH) mm Dimensions	Koli Adeti Quantity in Carton	Fiyat Price
A D	BL-O2-3001	15W	4000 K	2160	300 × 300 × 110	1	\$156
A D	BL-O2-3002	15W	6500 K	2160	300 × 300 × 110	1	\$156
A E	BL-O2-4001	35W	4000 K	4200	600 × 600 × 100	1	\$239,2
A E	BL-O2-4002	35W	6500 K	4200	600 × 600 × 100	1	\$239,2

## LED BACKLIGHT STERIL ORTAM SIVA ÜSTÜ ARMATÜR LED BACKLIGHT STERILE AMBIENT ARMATURE

Enerji Verimliliği Sınıfı Energy Efficiency Class	Ürün Kodu Product Code	Güç (W) Power	Renk Sıcaklığı (K) Color Temperature	Işık Akısı (Lm) Luminous Flux	Boyutlar (WxLxH) mm Dimensions	Koli Adeti Quantity in Carton	Fiyat Price
A D	BL-O5-3001	15W	4000 K	2160	300 × 300 × 110	1	\$171,6
A D	BL-O5-3002	15W	6500 K	2160	300 × 300 × 110	1	\$171,6
A E	BL-O5-4001	35W	4000 K	4200	600 × 600 × 100	1	\$260
A E	BL-O5-4002	35W	6500 K	4200	600 × 600 × 100	1	\$260

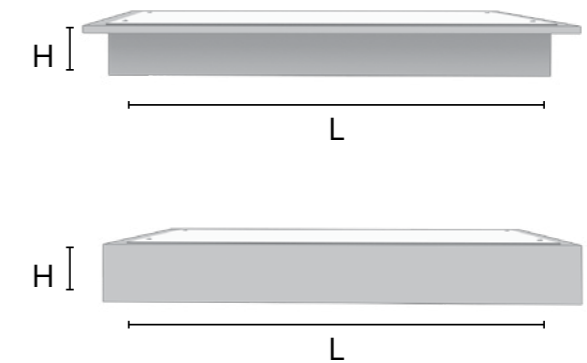
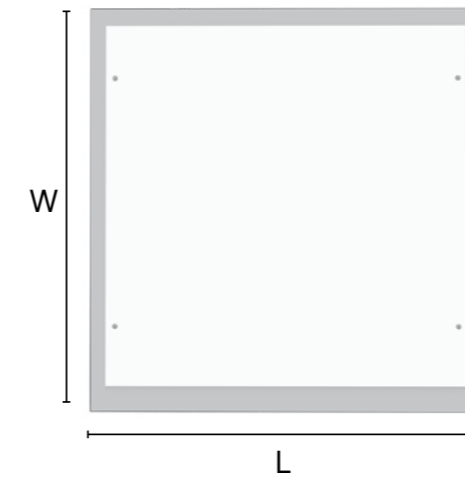



# LED PROJKTÖR PLATİN SERİSİ

## LED FLOODLIGHT PROJECTOR PLATINUM SERIES

### Teknik Özellikler

#### Technical Specifications

Gövde : Alüminyum  
Body : Aluminium

Cam : Temperli Cam  
Glass : Tempered Glass

Renksel Geri Verim : 70  
Color Rendering Index : 70

IP Derecesi : IP65  
IP Rating : IP65

IK Derecesi : IK08  
IK Rating : IK08

Elektriksel Koruma : Sınıf I  
Electrical Protection : Class I



### LED PROJKTÖR PLATİN SERİSİ

Led Projektörleri uzun mesafeli açık alanlarda, şehir meydanlarında, spor sahalarında, fabrika ve tesislerin aydınlatması vb birçok alanda rahatlıkla tercih edebilirsiniz. Darbelere dayanıklı, su ve toz geçirmez. IP65 standartlarına uygundur. Enerji tasarrufu, güvenilir performans ve uzun ömürlü kullanım sağlar.

### LED FLOODLIGHT PROJECTOR PLATINUM SERIES

You can easily choose Led Floodlight Projectors in long-distance open areas, city squares, sports fields, lighting of factories and facilities, etc. Shockproof, waterproof and dustproof. It complies with IP65 standards. It provides energy-saving, reliable performance and long-lasting use.

# LED PROJKTÖR PLATİN SERİSİ

## LED FLOODLIGHT PROJECTOR PLATINUM SERIES

TURQUALITY®

Enerji Verimliliği Sınıfı Energy Efficiency Class	Ürün Kodu Product Code	Güç (W) Power	Renk Sıcaklığı (K) Color Temperature	Işık Akısı (Lm) Luminous Flux	Boyutlar (WxLxH) mm Dimensions	Renk Color	Koli Adeti Quantity in Carton	Fiyat Price	
A+G	F	BL-P2-0001	10W	6500 K	800	87 × 115 × 32	Siyah	32	\$11,10
A+G	F	BL-P2-0002	10W	4000 K	800	87 × 115 × 32	Siyah	32	\$11,10
A+G	F	BL-P2-0003	10W	3000 K	800	87 × 115 × 32	Siyah	32	\$11,10
A+G	F	BL-P2-0004	20W	6500 K	1600	107 × 137 × 32	Siyah	32	\$15,90
A+G	F	BL-P2-0005	20W	4000 K	1600	107 × 137 × 32	Siyah	32	\$15,90
A+G	F	BL-P2-0006	20W	3000 K	1600	107 × 137 × 32	Siyah	32	\$15,90
A+G	F	BL-P2-0007	30W	6500 K	2400	140 × 180 × 33	Siyah	16	\$23,70
A+G	F	BL-P2-0008	30W	4000 K	2400	140 × 180 × 33	Siyah	16	\$23,70
A+G	F	BL-P2-0009	30W	3000 K	2400	140 × 180 × 33	Siyah	16	\$23,70
A+G	F	BL-P2-0010	50W	6500 K	4000	185 × 227 × 36	Siyah	10	\$33,50
A+G	F	BL-P2-0011	50W	4000 K	4000	185 × 227 × 36	Siyah	10	\$33,50
A+G	F	BL-P2-0012	50W	3000 K	4000	185 × 227 × 36	Siyah	10	\$33,50
A+G	F	BL-P2-0013	70W	6500 K	5600	240 × 290 × 40	Siyah	5	\$57,10
A+G	F	BL-P2-0014	70W	4000 K	5600	240 × 290 × 40	Siyah	5	\$57,10
A+G	F	BL-P2-0015	70W	3000 K	5600	240 × 290 × 40	Siyah	5	\$57,10
A+G	F	BL-P2-0016	100W	6500 K	8000	240 × 290 × 40	Siyah	5	\$64,80
A+G	F	BL-P2-0017	100W	4000 K	8000	240 × 290 × 40	Siyah	5	\$64,80
A+G	F	BL-P2-0018	100W	3000 K	8000	240 × 290 × 40	Siyah	5	\$64,80
A+G	F	BL-P2-0019	150W	6500 K	12000	290 × 370 × 61	Siyah	3	\$112,20
A+G	F	BL-P2-0020	150W	4000 K	12000	290 × 370 × 61	Siyah	3	\$112,20
A+G	F	BL-P2-0021	150W	3000 K	12000	290 × 370 × 61	Siyah	3	\$112,20
A+G	F	BL-P2-0022	200W	6500 K	16000	310 × 440 × 65	Siyah	3	\$149,80
A+G	F	BL-P2-0023	200W	4000 K	16000	310 × 440 × 65	Siyah	3	\$149,80
A+G	F	BL-P2-0024	200W	3000 K	16000	310 × 440 × 65	Siyah	3	\$149,80

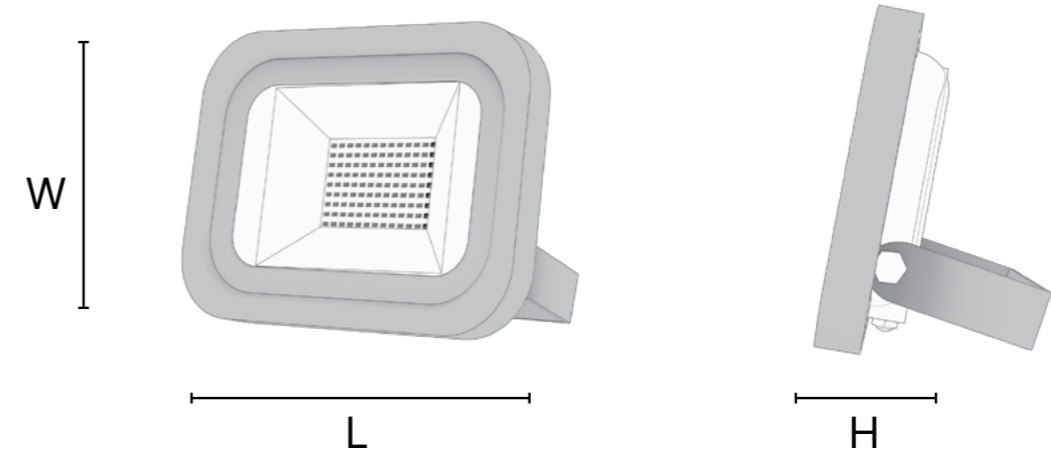

## LED PROJKTÖR PLATIN SERİSİ

### LED FLOODLIGHT PROJECTOR PLATINUM SERIES

#### Teknik Özellikler

#### Technical Specifications

Gövde : Alüminyum  
Body : Aluminium

Cam : Temperli Cam  
Glass : Tempered Glass

Renksel Geri Verim : 70  
Color Rendering Index : 70

IP Derecesi : IP65  
IP Rating : IP65

IK Derecesi : IK08  
IK Rating : IK08

Elektriksel Koruma : Sınıf I  
Electrical Protection : Class I



#### SENSÖRLÜ LED PROJKTÖR PLATİN SERİSİ

Ayarlanabilir hareket sensörü ile önemli miktarda enerji tasarrufu, güvenilir performans ve uzun ömürlü kullanım sağlar. IP65 standartlarına uygun olarak darbelere dayanıklı, su ve toz geçirmez.

#### SENSOR LED FLOODLIGHT PROJECTOR PLATINUM SERIES

With its adjustable motion sensor, it provides significant energy savings, reliable performance and long-lasting use.

Shockproof, waterproof and dustproof in accordance with IP65 standards.

#### YEŞİL LED PROJKTÖR PLATİN SERİSİ

Peyzaj mimarisinde, çevre ve mekanların estetik aydınlatılmasına uygundur. Enerji tasarrufu, güvenilir performans ve uzun ömürlü kullanım sağlar. IP65 standartlarına uygun olarak darbelere dayanıklı, su ve toz geçirmez.

#### GREEN LED FLOODLIGHT PROJECTOR PLATINUM SERIES

In landscape architecture, it is suitable for the aesthetic lighting of the environment and spaces. It provides energy-saving, reliable performance and long-lasting use. Shockproof, waterproof and dustproof by IP65 standards.

## SENSÖRLÜ LED PROJKTÖR PLATİN SERİSİ

### SENSOR LED FLOODLIGHT PROJECTOR PLATINUM SERIES

Enerji Verimliliği Sınıfı Energy Efficiency Class	Ürün Kodu Product Code	Güç (W) Power	Renk Sıcaklığı (K) Color Temperature	Işık Akısı (Lm) Luminous Flux	Boyutlar (WxLxH) mm Dimensions	Renk Color	Koli Adeti Quantity in Carton	Fiyat Price
A+G F	BL-P2-0001-S	10W	6500 K	800	87 × 115 × 32	Siyah	32	\$28,20
A+G F	BL-P2-0003-S	10W	3000 K	800	87 × 115 × 32	Siyah	32	\$28,20
A+G F	BL-P2-0004-S	20W	6500 K	1600	107 × 137 × 32	Siyah	32	\$33,90
A+G F	BL-P2-0006-S	20W	3000 K	1600	107 × 137 × 32	Siyah	32	\$33,90
A+G F	BL-P2-0007-S	30W	6500 K	2400	140 × 180 × 33	Siyah	16	\$44,60
A+G F	BL-P2-0009-S	30W	3000 K	2400	140 × 180 × 33	Siyah	16	\$44,50
A+G F	BL-P2-0010-S	50W	6500 K	4000	185 × 227 × 36	Siyah	10	\$57,90
A+G F	BL-P2-0012-S	50W	3000 K	4000	185 × 227 × 36	Siyah	10	\$57,90

## YEŞİL LED PROJKTÖR PLATİN SERİSİ

### GREEN LED FLOODLIGHT PROJECTOR PLATINUM SERIES

Enerji Verimliliği Sınıfı Energy Efficiency Class	Ürün Kodu Product Code	Güç (W) Power	Renk Sıcaklığı (K) Color Temperature	Işık Akısı (Lm) Luminous Flux	Boyutlar (WxLxH) mm Dimensions	Renk Color	Koli Adeti Quantity in Carton	Fiyat Price
A+G F	BL-P2-1GRN	10W	Yeşil Green	800	87 × 115 × 32	Siyah	32	\$13,30
A+G F	BL-P2-2GRN	20W	Yeşil Green	1600	107 × 137 × 32	Siyah	32	\$20,40
A+G F	BL-P2-3GRN	30W	Yeşil Green	2400	140 × 180 × 33	Siyah	16	\$29,10
A+G F	BL-P2-5GRN	50W	Yeşil Green	4000	185 × 227 × 36	Siyah	10	\$40,50

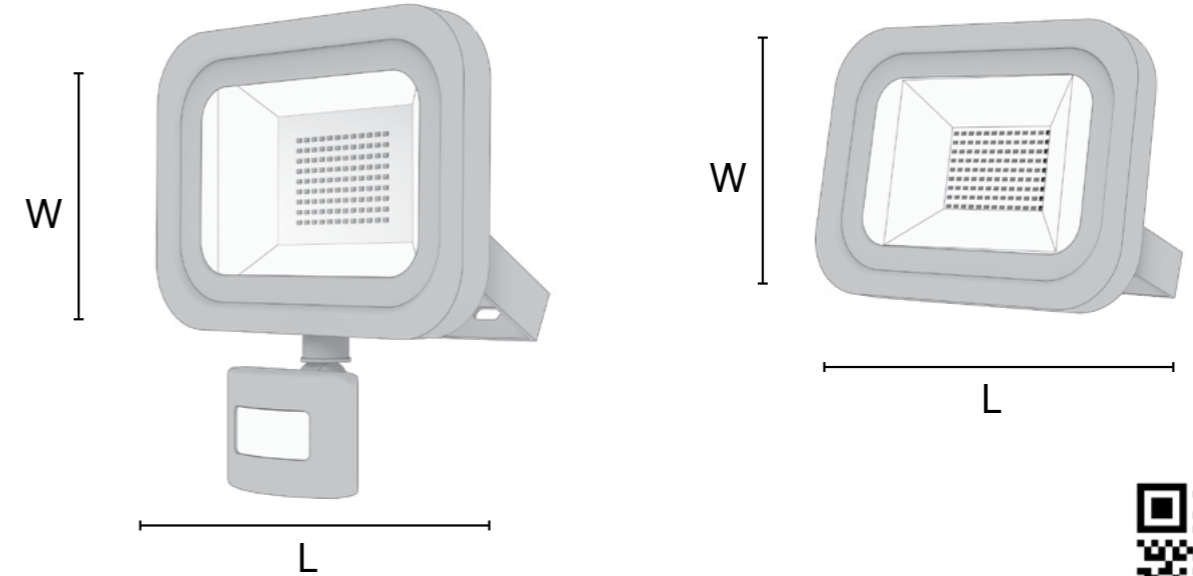

Teknik veri / Datasheet

www.borled.com.tr

# LED PROJKTÖR GOLD SERİSİ

## LED FLOODLIGHT PROJECTOR GOLD SERIES

### Teknik Özellikler

#### Technical Specifications

Gövde : Alüminyum  
Body : Aluminium

Cam : Temperli Cam  
Glass : Tempered Glass

Renksel Geri Verim : 80  
Color Rendering Index : 80

IP Derecesi : IP65  
IP Rating : IP65

IK Derecesi : IK08  
IK Rating : IK08

Elektriksel Koruma : Sınıf I  
Electrical Protection : Class I

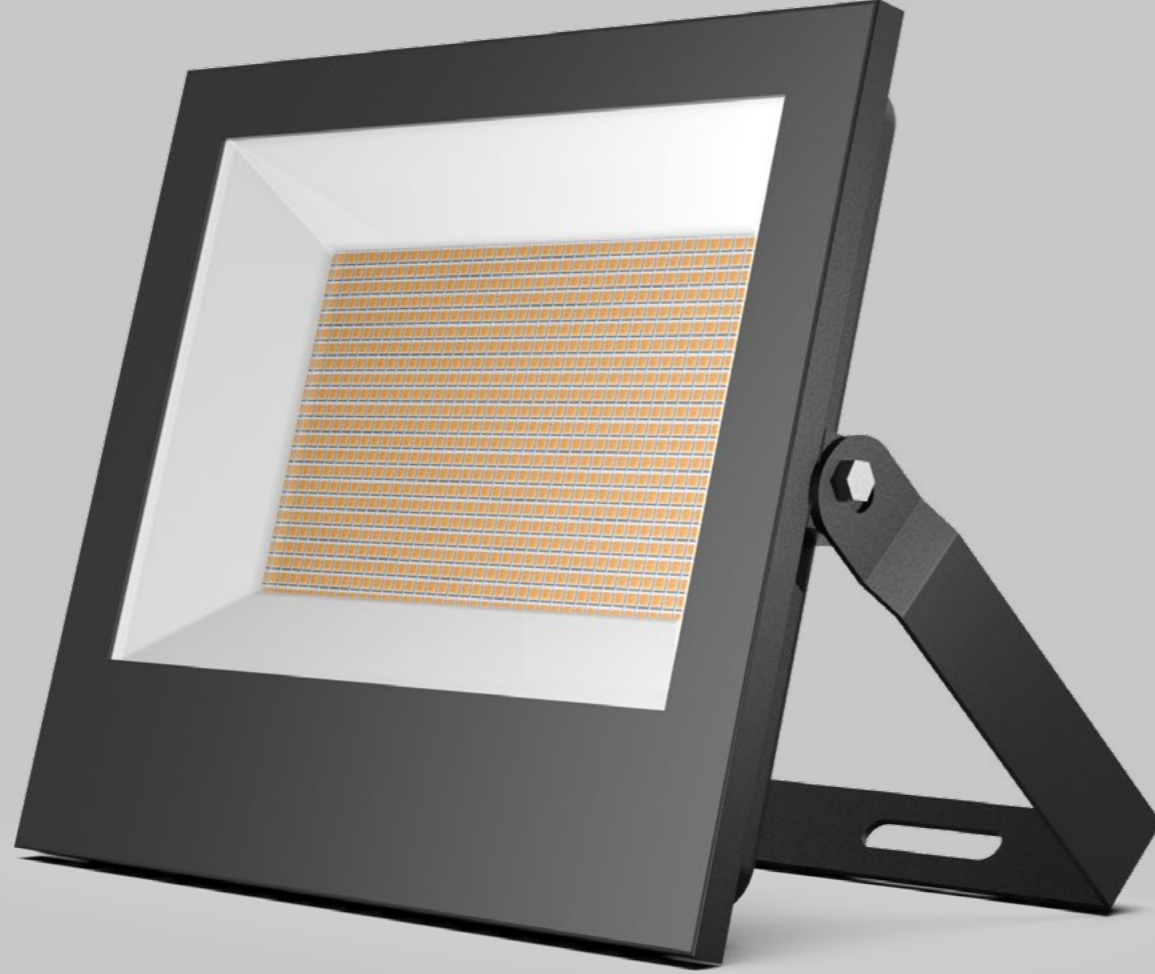

### LED PROJKTÖR GOLD SERİSİ

Led Projektörleri uzun mesafeli açık alanlarda, şehir meydanlarında, spor sahalarında, fabrika ve tesislerin aydınlatması vb birçok alanda rahatlıkla tercih edebilirsiniz. Darbelere dayanıklı, su ve toz geçirmez. IP65 standartlarına uygundur. Enerji tasarrufu, güvenilir performans ve uzun ömürlü kullanım sağlar.

### LED FLOODLIGHT PROJECTOR GOLD SERIES

You can easily choose Led Floodlight Projectors in long-distance open areas, city squares, sports fields, lighting of factories and facilities, etc. Shockproof, waterproof and dustproof. It complies with IP65 standards. It provides energy-saving, reliable performance and long-lasting use.

# LED PROJKTÖR GOLD SERİSİ

## LED FLOODLIGHT PROJECTOR GOLD SERIES

TURQUALITY®

Enerji Verimliliği Sınıfı Energy Efficiency Class	Ürün Kodu Product Code	Güç (W) Power	Renk Sıcaklığı (K) Color Temperature	Işık Akısı (Lm) Luminous Flux	Boyutlar (WxLxH) mm Dimensions	Renk Color	Koli Adeti Quantity in Carton	Fiyat Price	
A+G	F	BL-P4-0001	10W	3000 K	800	69 × 98 × 25	Siyah-Black	36	\$7,40
A+G	F	BL-P4-0003	10W	6500 K	800	69 × 98 × 25	Siyah-Black	36	\$7,40
A+G	F	BL-P4-0004	20W	3000 K	1600	92 × 123 × 28	Siyah-Black	36	\$11,20
A+G	F	BL-P4-0006	20W	6500 K	1600	92 × 123 × 28	Siyah-Black	36	\$11,20
A+G	F	BL-P4-0007	30W	3000 K	2400	117 × 157 × 28	Siyah-Black	32	\$16,30
A+G	F	BL-P4-0009	30W	6500 K	2400	117 × 157 × 28	Siyah-Black	32	\$16,30
A+G	F	BL-P4-0010	50W	3000 K	4000	144 × 202 × 28	Siyah-Black	16	\$23,70
A+G	F	BL-P4-0012	50W	6500 K	4000	144 × 202 × 28	Siyah-Black	16	\$23,70
A+G	F	BL-P4-0013	70W	3000 K	5600	186 × 241 × 28	Siyah-Black	10	\$29,20
A+G	F	BL-P4-0015	70W	6500 K	5600	186 × 241 × 28	Siyah-Black	10	\$29,20
A+G	F	BL-P4-0016	100W	3000 K	8000	206 × 266 × 30	Siyah-Black	10	\$43,40
A+G	F	BL-P4-0018	100W	6500 K	8000	206 × 266 × 30	Siyah-Black	10	\$43,40
A+G	F	BL-P4-0019	150W	3000 K	12000	230 × 326 × 32	Siyah-Black	5	\$68,30
A+G	F	BL-P4-0021	150W	6500 K	12000	230 × 326 × 32	Siyah-Black	5	\$68,30
A+G	F	BL-P4-0022	200W	3000 K	16000	247 × 350 × 34	Siyah-Black	5	\$86,50
A+G	F	BL-P4-0024	200W	6500 K	16000	247 × 350 × 34	Siyah-Black	5	\$86,50
A+G	F	BL-P4-0025	300W	3000 K	24000	356 × 470 × 36.5	Siyah-Black	2	\$172,30
A+G	F	BL-P4-0027	300W	6500 K	24000	356 × 470 × 36.5	Siyah-Black	2	\$172,30
A+G	F	BL-P4-0028	400W	3000 K	32000	386 × 518 × 77	Siyah-Black	2	\$254,30
A+G	F	BL-P4-0030	400W	6500 K	32000	386 × 518 × 77	Siyah-Black	2	\$254,30

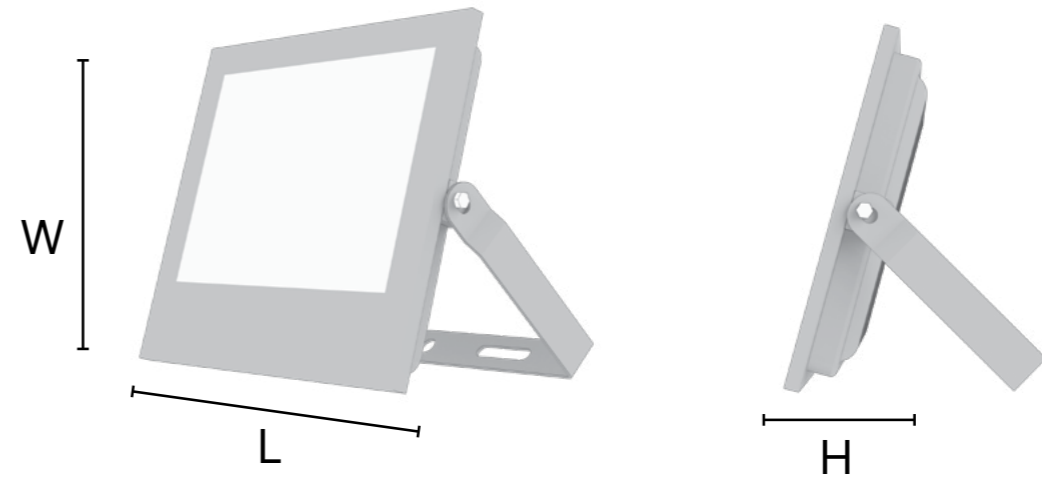

# SOLAR PROJKTOR SOLAR FLOODLIGHT

## Teknik Özellikler Technical Specifications

Gövde : Alüminyum  
Body : Aluminium

Cam : Temperli Cam  
Glass : Tempered Glass

Renksel Geri Verim : 70  
Color Rendering Index : 70

IP Derecesi : IP65  
IP Rating : IP65

IK Derecesi : IK07  
IK Rating : IK07

Batarya : 26700 4000mA 3.2V  
Battery : 26700 4000mA 3.2V

Çalışma Sıcaklığı : -15°C / 45°C  
Operating Temp. Range : -15°C / 45°C



### SOLAR PROJKTOR

Bu ürün çevre dostudur. Şarj etmek için güneş enerjisi kullanır, bu nedenle temiz ve sürdürülebilirdir. Kurulumu kolaydır. Elektrik bağlantısı gerektirmez. IP65 koruma sınıfına sahiptir. Dış ortam koşullarına dayanıklı uzun ömürlü ve verimli kullanım sağlar.

### SOLAR FLOODLIGHT

This product is environmentally friendly. It uses solar energy to charge, so it is clean and sustainable. It is easy to install. It does not require an electrical connection. It has an IP65 protection class. It provides long-lasting and efficient use resistant to outdoor conditions.

## SOLAR PROJKTOR SOLAR FLOODLIGHT

TURQUALITY®

Ürün Kodu Product Code	Güç (W) Power	Renk Sıcaklığı (K) Color Temperature	Işık Akısı (Lm) Luminous Flux	Boyutlar (WxLxH) mm Dimensions	Renk Color	Kablo Uzunluğu Cable Length	Fiyat Price
BL-SP-0001	50W	6500 K	550	210 × 200 × 17	Siyah-Black	3m	\$79,60
BL-SP-0002	150W	6500 K	1650	390 × 230 × 17	Siyah-Black	3m	\$128,60
BL-SP-0003	250W	6500 K	2750	390 × 300 × 17	Siyah-Black	3m	\$166,80
BL-SP-0004	350W	6500 K	3850	390 × 430 × 17	Siyah-Black	3m	\$228,30



## LED YÜKSEK TAVAN SPOTLARI LED HIGHBAY

### Teknik Özellikler Technical Specifications

Gövde : Alüminyum  
Body : Aluminium

Cam: Polikarbon Cam  
Glass: Polycarbon Glass

Sürücü: İzole Sürücü  
Driver: Isolated Driver

Giriş Gerilimi : 100-265 V AC  
Input Voltage: 100-265 V AC

Renksel Geri Verim: 80  
Color Rendering Index: 80

IP Derecesi : IP65  
IP Rating : IP65

Çalışma Sıcaklığı : -40°C / 45°C  
Operating Temp. Range : -40°C / 45°C



## LED YÜKSEK TAVAN SPOTLARI ONBOARD LED HIGHBAY ONBOARD

### Teknik Özellikler Technical Specifications

Gövde : Alüminyum  
Body : Aluminium

Cam: Polikarbon Cam  
Glass: Polycarbon Glass

Sürücü: On-Board  
Driver: DOB

Giriş Gerilimi : 100-265 V AC  
Input Voltage: 100-265 V AC

Renksel Geri Verim: 80  
Color Rendering Index: 80

IP Derecesi : IP65  
IP Rating : IP65

Çalışma Sıcaklığı : -40°C / 45°C  
Operating Temp. Range : -40°C / 45°C



### LED HIGHBAY

Led yüksek tavan spotları atölye, ticari, depo aydınlatması vb. için çok uygundur. Tasarım yapısı uzun ömürlü, verimli ve parlaktır. Su, toz geçirmez IP65 koruma daha kolay temizlik ve bakım sağlar.

### LED HIGHBAY ONBOARD

Led high bay spotlights are very suitable for workshop, commercial, warehouse lighting etc. The design structure is long life, efficient and bright. Water, dustproof IP65 protection makes easier cleaning and maintenance.

## LED YÜKSEK TAVAN SPOTLARI LED HIGHBAY

Enerji Verimliliği Sınıfı Energy Efficiency Class	Ürün Kodu Product Code	Güç (W) Power	Renk Sıcaklığı (K) Color Temperature	Işık Akısı (Lm) Luminous Flux	Boyutlar (ØxH) mm Dimensions	Koli Adeti Quantity in Carton	Fiyat Price
A F	BL-HB-0001	100W	3000 K	10.000	250 X 100	1	\$86,40
A F	BL-HB-0002	100W	6500 K	10.000	250 X 100	1	\$86,40
A F	BL-HB-0003	150W	3000 K	15.000	290 X 100	1	\$117,70
A F	BL-HB-0004	150W	6500 K	15.000	290 X 100	1	\$117,70
A F	BL-HB-0005	200W	3000 K	20.000	355 X 100	1	\$142,70
A F	BL-HB-0006	200W	6500 K	20.000	355 X 100	1	\$142,70

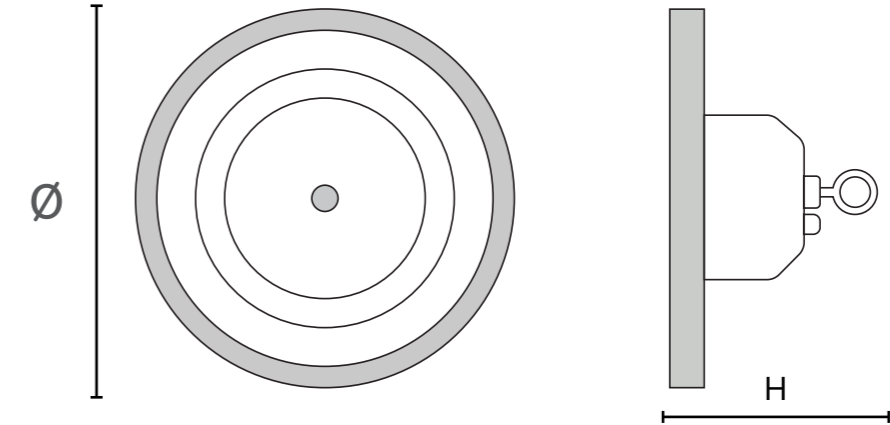

## LED YÜKSEK TAVAN SPOTLARI ONBOARD LED HIGHBAY ONBOARD

Enerji Verimliliği Sınıfı Energy Efficiency Class	Ürün Kodu Product Code	Güç (W) Power	Renk Sıcaklığı (K) Color Temperature	Işık Akısı (Lm) Luminous Flux	Boyutlar (ØxH) mm Dimensions	Koli Adeti Quantity in Carton	Fiyat Price
A F	BL-HB-1001	100W	3000 K	10.000	270 X 42	1	\$58,40
A F	BL-HB-1002	100W	6500 K	10.000	270 X 42	1	\$58,40
A F	BL-HB-1003	150W	3000 K	15.000	311 X 42	1	\$82,60
A F	BL-HB-1004	150W	6500 K	15.000	311 X 42	1	\$82,60
A F	BL-HB-1005	200W	3000 K	20.000	383 X 42	1	\$108,50
A F	BL-HB-1006	200W	6500 K	20.000	383 X 42	1	\$108,50

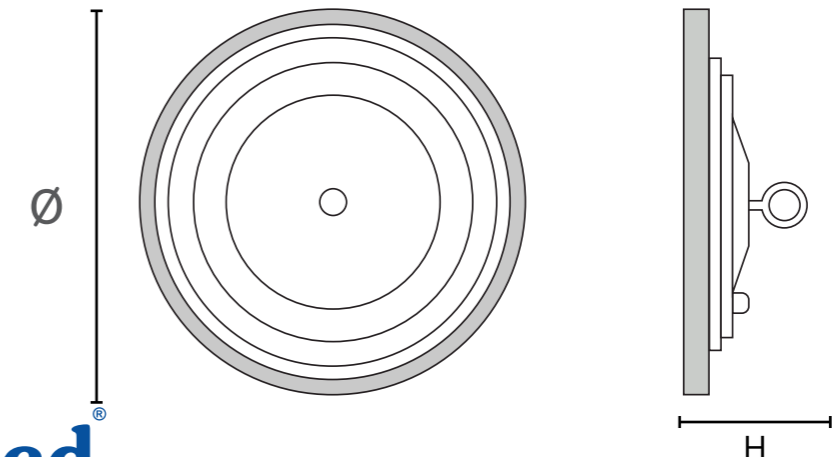

Teknik veri / Datasheet

www.borled.com.tr

# LED SOKAK AYDINLATMA ARMATÜRÜ

## LED STREET LIGHTING ARMATURE

### Teknik Özellikler

#### Technical Specifications

Gövde : Alüminyum  
Body : Aluminium

Cam : Polikarbonat Cam  
Glass : Polycarbonate Glass

Renksel Geri Verim : 70  
Color Rendering Index : 70

IP Derecesi : IP65  
IP Rating : IP65

IK Derecesi : IK07  
IK Rating : IK07

Elektriksel Koruma : Sınıf I  
Electrical Protection : Class I



### LED SOKAK AYDINLATMA ARMATÜRÜ

Led Şehir Aydınlatma Armatürleri, yayalar ve sürücüler için azami görüş konforu ve yol güvenliği sağlar. Sodyum ve cıva içeren lambalara göre düşük enerji gereksinimi, yüksek renksel geri verim, farklı renk sıcaklık seçenekleri, DIM ayar ve zamanlama otomasyon avantajlarına sahiptir. İlave olarak estetik ve kompakt armatür yapısı ile darbeler ve şoka dayanıklıdır. Uzun ömürlü ve bakım maliyetleri düşüktür.

### LED STREET LIGHTING ARMATURE

Led City Lighting Fixtures to provide maximum visibility comfort and road safety for pedestrians and drivers. Compared to lamps containing sodium and mercury, it has the advantages of low energy requirement, high colour rendering, different colour temperature options, DIM adjustment and timing automation. In addition, it is resistant to impacts and shocks with its aesthetic and compact armature structure, long life and low maintenance costs.

# LED SOKAK AYDINLATMA ARMATÜRÜ

## LED STREET LIGHTING ARMATURE

TURQUALITY®

Enerji Verimliliği Sınıfı Energy Efficiency Class	Ürün Kodu Product Code	Güç (W) Power	Renk Sıcaklığı (K) Color Temperature	Işık Akısı (Lm) Luminous Flux	Boyutlar (WxLxH) mm Dimensions	Renk Color	Koli Adeti Quantity in Carton	Fiyat Price
A F G	BL-C2-2001	60W	3000 K	5400	150 × 400 × 63	Gri	4	\$68,90
A F G	BL-C2-2007	60W	4000 K	5400	150 × 400 × 63	Gri	4	\$68,90
A F G	BL-C2-2002	60W	6500 K	5400	150 × 400 × 63	Gri	4	\$68,90
A F G	BL-C2-2003	90W	3000 K	8100	165 × 465 × 63	Gri	4	\$87,80
A F G	BL-C2-2008	90W	4000 K	8100	165 × 465 × 63	Gri	4	\$87,80
A F G	BL-C2-2004	90W	6500 K	8100	165 × 465 × 63	Gri	4	\$87,80
A F G	BL-C2-2005	120W	3000 K	10800	180 × 585 × 73	Gri	4	\$107,20
A F G	BL-C2-2009	120W	4000 K	10800	180 × 585 × 73	Gri	4	\$107,20
A F G	BL-C2-2006	120W	6500 K	10800	180 × 585 × 73	Gri	4	\$107,20

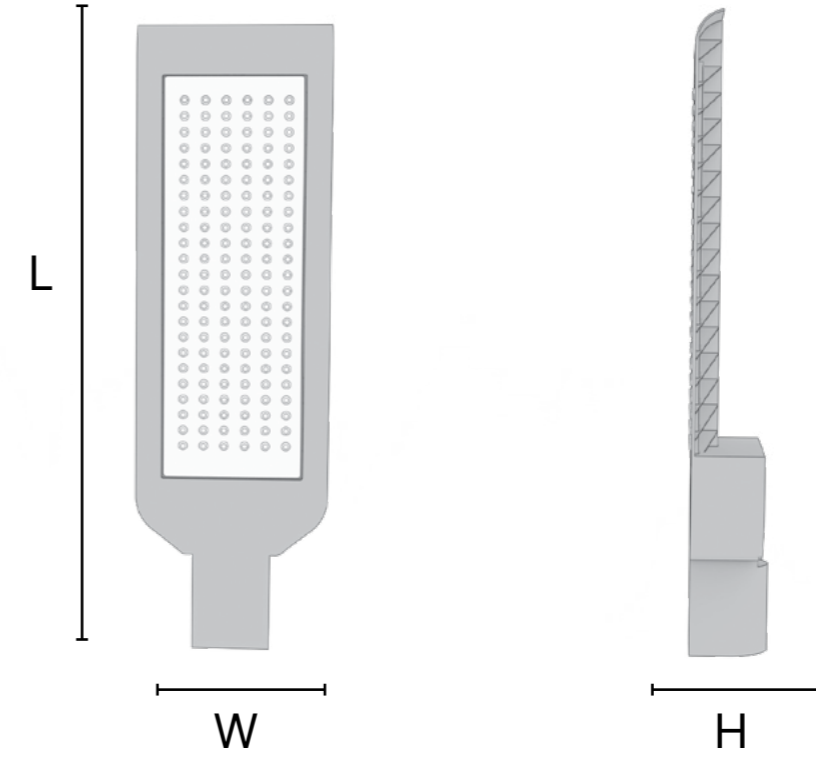

# SOKAK AYDINLATMA PROJE ARMATÜRÜ

## STREET LIGHTING PROJECT ARMATURE

### Teknik Özellikler

#### Technical Specifications

Gövde : Alüminyum  
Body : Aluminium

Gövde Renkleri : Antrasit  
Body Colors : Anthracite

Cam : Tamperli  
Glass : Tempered

PF : >0.9  
PF : >0.9

Renksel Geri Verim : 70  
Color Rendering Index : 70

IP Derecesi : IP65  
IP Rating : IP65

CRI : >70  
CRI : >70

Işık Açısı : 110°  
Light Angle : 110°

Yüksek Gerilim Koruması : 10kV  
High Voltage Protection : 10kV



### SOKAK AYDINLATMA PROJE ARMATÜRÜ

LED Çip kullanan güçlü enerji tasarruflu projektörler 1000 lümen ila 20000Lm ışık yayarak geleneksel metal-halide (MH) ışıkların ve akkor armatürlerin yerini almıştır. LED sokak projektörleri AC85-265V arasında geniş bir giriş voltajı aralığında çalışır ve 50.000 saat daha uzun süre dayanacak şekilde tasarlanmıştır. Su ve toz geçirmez, IP 65 entegre bir ısı emici ve temperli alüminyum gövdeye sahiptir. Ayarlanabilir montaj braket, aydınlatmayı ihtiyaç duyulan yere yönlendirmenizi sağlar.

### STREET LIGHTING PROJECT ARMATURE

Powerful energy-efficient floodlights using LED Chips emit 1000 lumens to 20000Lm of light, replacing traditional metal-halide (MH) lights and incandescent fixtures. LED street floodlights operate over a wide input voltage range from AC85-265V and are designed to last 50,000 hours longer. Waterproof and dustproof, IP 65 has an integrated heat sink and tempered aluminium housing. The adjustable mounting bracket allows you to direct the lighting where it is needed.

# SOKAK AYDINLATMA PROJE ARMATÜRÜ

## STREET LIGHTING PROJECT ARMATURE

TURQUALITY®

Enerji Verimliliği Sınıfı Energy Efficiency Class	Ürün Kodu Product Code	Güç (W) Power	Renk Sıcaklığı (K) Color Temperature	Işık Akısı (Lm) Luminous Flux	Boyutlar (WxLxH) mm Dimensions	Kesim Ölçüsü (Çap) Cutting Size (Diameter)	Renk Color	Koli Adeti Quantity in Carton	Fiyat Price
A T G	BL-PRJ-0001	50W	3000 K	8000	535 × 210 × 110	55mm	Antrasit Anthracite	50	\$299,70
A T G	BL-PRJ-0002	50W	4000 K	8000	535 × 210 × 110	55mm	Antrasit Anthracite	50	\$299,70
A T G	BL-PRJ-0003	50W	6500 K	8000	535 × 210 × 110	55mm	Antrasit Anthracite	50	\$299,70
A T G	BL-PRJ-0004	100W	3000 K	16000	605 × 265 × 110	55mm	Antrasit Anthracite	50	\$404,00
A T G	BL-PRJ-0005	100W	4000 K	16000	605 × 265 × 110	55mm	Antrasit Anthracite	50	\$404,00
A T G	BL-PRJ-0006	100W	6500 K	16000	605 × 265 × 110	55mm	Antrasit Anthracite	50	\$404,00
A T G	BL-PRJ-0007	150W	3000 K	24000	710 × 265 × 110	55mm	Antrasit Anthracite	50	\$484,50
A T G	BL-PRJ-0008	150W	4000 K	24000	710 × 265 × 110	55mm	Antrasit Anthracite	50	\$484,50
A T G	BL-PRJ-0009	150W	6500 K	24000	710 × 265 × 110	55mm	Antrasit Anthracite	50	\$484,50
A T G	BL-PRJ-0010	200W	3000 K	32000	760 × 265 × 110	55mm	Antrasit Anthracite	50	\$565,00
A T G	BL-PRJ-0011	200W	4000 K	32000	760 × 265 × 110	55mm	Antrasit Anthracite	50	\$565,00
A T G	BL-PRJ-0012	200W	6500 K	32000	760 × 265 × 110	55mm	Antrasit Anthracite	50	\$565,00
A T G	BL-PRJ-0013	300W	3000 K	48000	810 × 265 × 110	55mm	Antrasit Anthracite	50	\$806,30
A T G	BL-PRJ-0014	300W	4000 K	48000	810 × 265 × 110	55mm	Antrasit Anthracite	50	\$806,30
A T G	BL-PRJ-0015	300W	6500 K	48000	810 × 265 × 110	55mm	Antrasit Anthracite	50	\$806,30



## LED SOKAK AYDINLATMA ARMATÜRÜ – DOB

### LED STREET LIGHTING ARMATURE - DOB

#### Teknik Özellikler

#### Technical Specifications

Gövde : Alüminyum  
Body : Aluminium

Gövde Renkleri : Gri  
Body Colors : Gray

PF : >0.9  
PF : >0.9

Renksel Geri Verim : 70  
Color Rendering Index : 70

IP Derecesi : IP65  
IP Rating : IP65

Işık Açısı : 110°  
Light Angle : 110°

Çalışma Sıcaklığı : -20 C / 45 C  
Operating Temp. Range : -20 C / 45 C

Çalışma Gerilimi : AC100-265V  
Operating Voltage : AC100-265V



LED SOKAK AYDINLATMA ARMATÜRÜ – DOB  
Verimli ve şık tasarımı ile sofistike bir görünüm sergiler. Sağlam alüminyum alaşım gövde dayanıklılık sağlar. 150W kadar çok yönlü bir güç aralığı sunan bu ürün, verimlilik ve zarafeti sorunsuz bir şekilde harmanlayarak çeşitli dış mekan aydınlatma ihtiyaçlarını karşılar.

LED STREET LIGHTING ARMATURE - DOB  
Efficient and stylish design with a sophisticated look. The robust aluminum alloy housing ensures durability. Offering a versatile power range of up to 150W, it seamlessly blends efficiency and elegance to meet a variety of outdoor lighting needs.

## LED SOKAK AYDINLATMA ARMATÜRÜ – DOB

### LED STREET LIGHTING ARMATURE - DOB

Enerji Verimliliği Sınıfı Energy Efficiency Class	Ürün Kodu Product Code	Güç (W) Power	Renk Sıcaklığı (K) Color Temperature	Işık Akısı (Lm) Luminous Flux	Boyutlar (WxLxH) mm Dimensions	Konsol Delik Çapı Console Hole Diameter	Renk Color	Koli Adeti Quantity in Carton	Fiyat Price
A T G F	BL-DOB-0001	100W	3000 K	12000	185 × 82 × 425	55mm	Gri Gray	4	\$60,10
A T G F	BL-DOB-0002	100W	4000 K	12000	185 × 82 × 425	55mm	Gri Gray	4	\$60,10
A T G F	BL-DOB-0003	100W	6500 K	12000	185 × 82 × 425	55mm	Gri Gray	4	\$60,10
A T G F	BL-DOB-0004	150W	3000 K	18000	225 × 82 × 516	55mm	Gri Gray	4	\$89,80
A T G F	BL-DOB-0005	150W	4000 K	18000	225 × 82 × 516	55mm	Gri Gray	4	\$89,80
A T G F	BL-DOB-0006	150W	6500 K	18000	225 × 82 × 516	55mm	Gri Gray	4	\$89,80





# SOLAR SOKAK AYDINLATMA ARMATÜRÜ

## SOLAR STREET LIGHTING ARMATURE

### Teknik Özellikler

#### Technical Specifications

Gövde : ABS  
Body : ABS

Cam : Polikarbonat Cam  
Glass : Polycarbonate Glass

Renksel Geri Verim : 70  
Color Rendering Index : 70

IP Derecesi : IP65  
IP Rating : IP65

IK Derecesi : IK07  
IK Rating : IK07

Elektriksel Koruma : Sınıf III  
Electrical Protection : Class III

Kumanda Algılama Mesafesi: 25 m  
Remote Control Detecting Distance: 25 m



### SOLAR SOKAK AYDINLATMA ARMATÜRÜ

Alüminyum alaşımlı ışık tasarımı. Yeni ısı dağıtım ve işleme teknolojisi ile gün boyunca elektrik enerjisi depolar. Su geçirmez (IP65) oksidasyon önleyici özellikleri ile korozyona ve dış etkenlere dayanıklıdır.

### SOLAR STREET LIGHTING ARMATURE

Stylish design with aluminium alloy. It stores electrical energy throughout the day with its new heat distribution and processing technology. It is resistant to corrosion and external factors with its waterproof (IP65) anti-oxidation properties.

# SOLAR SOKAK AYDINLATMA ARMATÜRÜ

## SOLAR STREET LIGHTING ARMATURE

TURQUALITY®

Ürün Kodu Product Code	Güç (W) Power	Batarya Kapasitesi (mAh) Battery Capacity	Renk Sıcaklığı (K) Color Temperature	Işık Akısı (Lm) Luminous Flux	Boyutlar (WxLxH) mm Dimensions	Renk Color	Koli Adeti Quantity in Carton	Fiyat Price
BL-SP-0010	80W	12000	3000 K	1150	240 × 725 × 45	Siyah	10	\$91,80
BL-SP-0011	80W	12000	4000 K	1150	240 × 725 × 45	Siyah	10	\$91,80
BL-SP-0012	80W	12000	6500 K	1150	240 × 725 × 45	Siyah	10	\$91,80
BL-SP-0013	100W	15000	3000 K	1450	240 × 820 × 60	Siyah	5	\$110,60
BL-SP-0014	100W	15000	4000 K	1450	240 × 820 × 60	Siyah	5	\$110,60
BL-SP-0015	100W	15000	6500 K	1450	240 × 820 × 60	Siyah	5	\$110,60

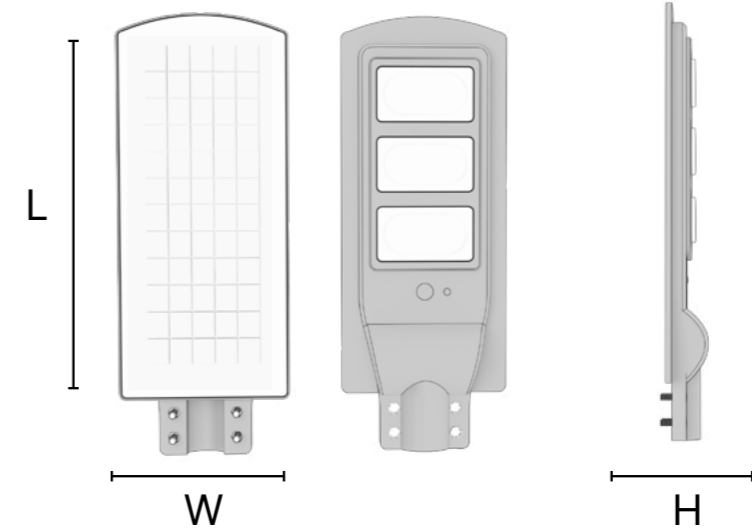

# SOLAR SOKAK AYDINLATMA ARMATÜRÜ

## SOLAR STREET LIGHTING ARMATURE

TURQUALITY®

### Teknik Özellikler

#### Technical Specifications

Gövde : ABS  
Body : ABS

Cam : Polikarbonat Cam  
Glass : Polycarbonate Glass

Renksel Geri Verim : 70  
Color Rendering Index : 70

IP Derecesi : IP65  
IP Rating : IP65

IK Derecesi : IK07  
IK Rating : IK07

Elektriksel Koruma : Sınıf III  
Electrical Protection : Class III

Kumanda Algılama Mesafesi: 25 m  
Remote Control Detecting Distance: 25 m



### SOLAR SOKAK AYDINLATMA ARMATÜRÜ

Alüminyum alaşımlı şık tasarım. Yeni ısı dağıtım ve işleme teknolojisi ile gün boyunca elektrik enerjisi depolar. Su geçirmez (IP65) oksidasyon önleyici özellikleri ile korozyona ve dış etkenlere dayanıklıdır.

### SOLAR STREET LIGHTING ARMATURE

Stylish design with aluminium alloy. It stores electrical energy throughout the day with its new heat distribution and processing technology. It is resistant to corrosion and external factors with its waterproof (IP65) anti-oxidation properties.

# SOLAR SOKAK AYDINLATMA ARMATÜRÜ

## SOLAR STREET LIGHTING ARMATURE

Ürün Kodu Product Code	Güç (W) Power	Renk Sıcaklığı (K) Color Temperature	Işık Akısı (Lm) Luminous Flux	Boyutlar (WxLxH) mm Dimensions	Renk Color	Koli Adeti Quantity in Carton	Fiyat Price
BL-SS-0001	200W	3000 K	2900	502 x 355 x 72	Siyah	3	\$158,00
BL-SS-0002	200W	4000 K	2900	502 x 355 x 72	Siyah	3	\$158,00
BL-SS-0003	200W	6500 K	2900	502 x 355 x 72	Siyah	3	\$158,00
BL-SS-0004	300W	3000 K	4350	732 x 355 x 72	Siyah	3	\$179,00
BL-SS-0005	300W	4000 K	4350	732 x 355 x 72	Siyah	3	\$179,00
BL-SS-0006	300W	6500 K	4350	732 x 355 x 72	Siyah	3	\$179,00

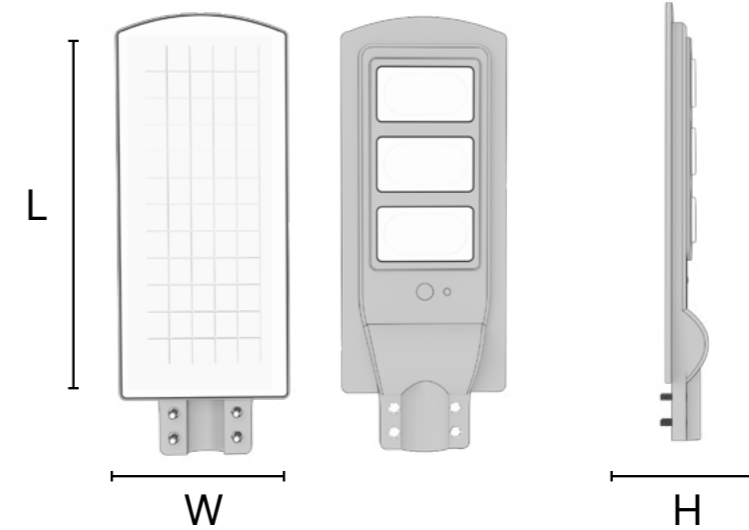

# LED WALL WASHER ARMATÜR LED WALL WASHER ARMATURE

## Teknik Özellikler Technical Specifications

Gövde : Alüminyum  
Body : Aluminum

Renk : Gri  
Color Gray

Renksel Geri Verim : 80  
Color Rendering Index : 80

IP Derecesi : IP65  
IP Rating : IP65

PF : <0.9  
PF : <0.9

Işık Açısı : 120°  
Light Angle : 120°

Çalışma Voltajı : 220-240V AC  
Operating Voltage : 220-240V AC

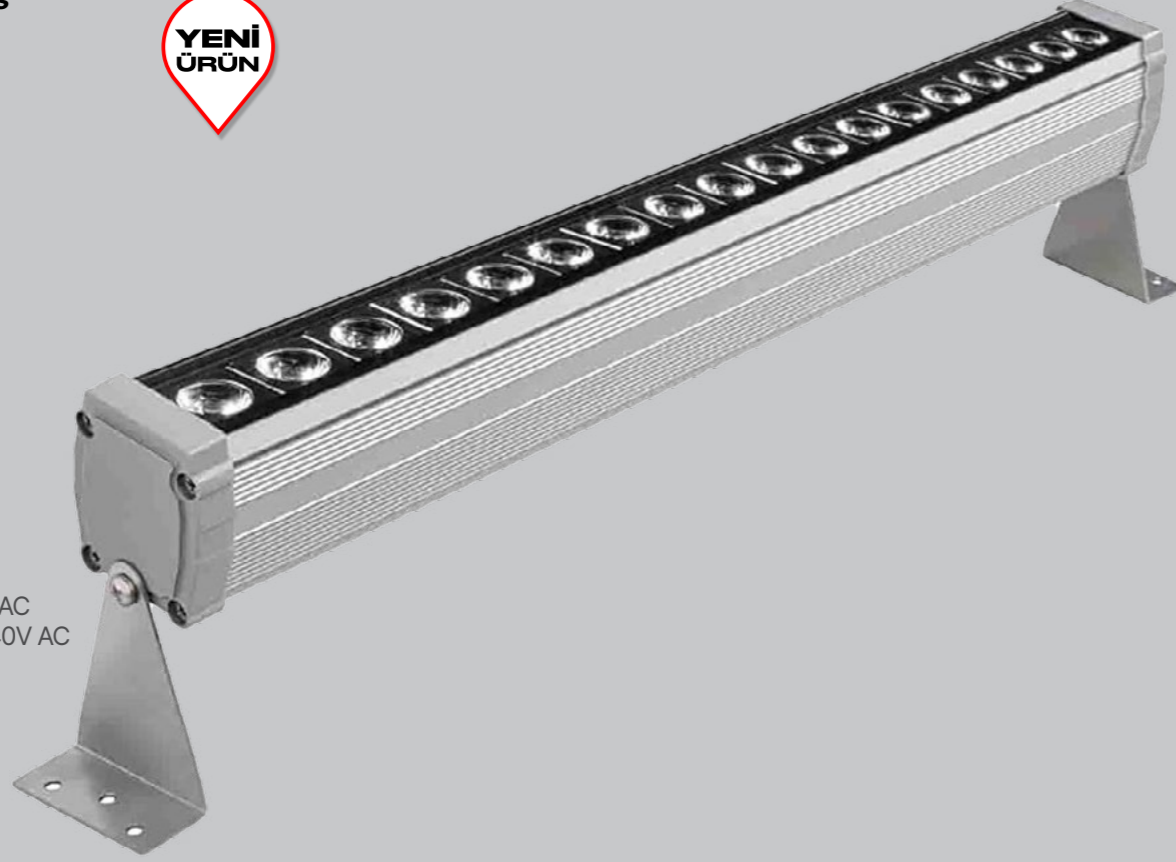

## LED WALL WASHER ARMATÜR

Cephe aydınlatması, binalar, saray, müze gibi kültürel alanlar, bahçe ve parklar dahil olmak üzere birçok alanda dekoratif aydınlatma olarak kullanılır. Darbeye dayanıklı temperli cam, 10-20 metre arası ışık yüksekliği, A+ Kalite led ve IP65 koruma sınıfı.

## LED WALL WASHER ARMATURE

It is used as decorative lighting in many areas including facade lighting, buildings, cultural areas such as palaces, museums, gardens and parks. Impact resistant tempered glass, light height between 10-20 meters, A+ Quality led and IP65 protection class.

# LED WALL WASHER ARMATÜR LED WALL WASHER ARMATURE

TURQUALITY®

Enerji Verimliliği Sınıfı Energy Efficiency Class	Ürün Kodu Product Code	Güç (W) Power	Renk Sıcaklığı (K) Color Temperature	Işık Akısı (Lm) Luminous Flux	Boyutlar (WxLxH) mm Dimensions	Renk Color	Koli Adeti Quantity in Carton	Fiyat Price
A+ F	BL-WW-0001	6W	3000 K	480	180 x 42 x 50	Gri-Gray	12	\$31,10
A+ F	BL-WW-0002	6W	4000 K	480	180 x 42 x 50	Gri-Gray	12	\$31,10
A+ F	BL-WW-0003	6W	6500 K	480	180 x 42 x 50	Gri-Gray	12	\$31,10
A+ F	BL-WW-0004	6W	RGB	480	180 x 42 x 50	Gri-Gray	12	\$35,00
A+ F	BL-WW-0005	9W	3000 K	720	276 x 42 x 50	Gri-Gray	12	\$35,70
A+ F	BL-WW-0006	9W	4000 K	720	276 x 42 x 50	Gri-Gray	12	\$35,70
A+ F	BL-WW-0007	9W	6500 K	720	276 x 42 x 50	Gri-Gray	12	\$35,70
A+ F	BL-WW-0008	9W	RGB	720	276 x 42 x 50	Gri-Gray	12	\$41,40
A+ F	BL-WW-0009	12W	3000 K	960	338 x 42 x 50	Gri-Gray	6	\$43,00
A+ F	BL-WW-0010	12W	4000 K	960	338 x 42 x 50	Gri-Gray	6	\$43,00
A+ F	BL-WW-0011	12W	6500 K	960	338 x 42 x 50	Gri-Gray	6	\$43,00
A+ F	BL-WW-0012	12W	RGB	960	338 x 42 x 50	Gri-Gray	6	\$48,00
A+ F	BL-WW-0013	18W	3000 K	1440	480 x 42 x 50	Gri-Gray	6	\$54,80
A+ F	BL-WW-0014	18W	4000 K	1440	480 x 42 x 50	Gri-Gray	6	\$54,80
A+ F	BL-WW-0015	18W	6500 K	1440	480 x 42 x 50	Gri-Gray	6	\$54,80
A+ F	BL-WW-0016	18W	RGB	1440	480 x 42 x 50	Gri-Gray	6	\$62,60
A+ F	BL-WW-0017	36W	3000 K	2880	945 x 42 x 50	Gri-Gray	6	\$83,10
A+ F	BL-WW-0018	36W	4000 K	2880	945 x 42 x 50	Gri-Gray	6	\$83,10
A+ F	BL-WW-0019	36W	6500 K	2880	945 x 42 x 50	Gri-Gray	6	\$83,10
A+ F	BL-WW-0020	36W	RGB	2880	945 x 42 x 50	Gri-Gray	6	\$95,90



# LED DUVAR APLİK LED WALL APLIKE



## Teknik Özellikler Technical Specifications

Gövde : Plastik  
Body : Plastic

Renk : Siyah  
Color : Black

Renksel Geri Verim : 80  
Color Rendering Index : 80

IP Derecesi : IP65  
IP Rating : IP65

Çalışma Voltajı : 220-240V AC  
Operating Voltage : 220-240V AC

Çalışma Sıcaklığı : -15°C / 45°C  
Operating Temp. Range : -15°C / 45°C



## LED DUVAR APLİK

Cephe aydınlatması, binalar, saray, müze gibi kültürel alanlar, bahçe ve parklar dahil olmak üzere birçok alanda dekoratif aydınlatma olarak kullanılır. Darbeye dayanıklı temperli cam, 10-20 metre arası ışık yüksekliği, A+ Kalite led ve IP65 koruma sınıfı.

## LED WALL APLIKE

It is used as decorative lighting in many areas including facade lighting, buildings, cultural areas such as palaces, museums, gardens and parks. Impact resistant tempered glass, light height between 10-20 meters, A+ Quality led and IP65 protection class.

# LED DUVAR APLİK LED WALL APLIKE

TURQUALITY®

Enerji Verimliliği Sınıfı Energy Efficiency Class	Ürün Kodu Product Code	Güç (W) Power	Renk Sıcaklığı (K) Color Temperature	Işık Akısı (Lm) Luminous Flux	Boyutlar (WxLxH) mm Dimensions	Gövde Tipi Color	Koli Adeti Quantity in Carton	Fiyat Price
A+G	BL-WA-0001	6W	3000K	400	108X108X80	Yuvarlak	12	\$17,90
A+G	BL-WA-0002	6W	6500K	400	108X108X80	Yuvarlak	12	\$17,90
A+G	BL-WA-0003	10W	3000K	650	170X170X80	Yuvarlak	12	\$21,70
A+G	BL-WA-0004	10W	6500K	650	170X170X80	Yuvarlak	12	\$21,70
A+G	BL-WA-0005	6W	3000K	400	108X108X80	Kare	12	\$17,90
A+G	BL-WA-0006	6W	6500K	400	108X108X80	Kare	12	\$17,90
A+G	BL-WA-0007	10W	3000K	650	170X170X80	Kare	12	\$21,70
A+G	BL-WA-0008	10W	6500K	650	170X170X80	Kare	12	\$21,70
A+G	BL-WA-0009	15W	3000K	1200	268X100X99	Oval	12	\$27,60
A+G	BL-WA-0010	15W	6500K	1200	268X100X99	Oval	12	\$27,60
A+G	BL-WA-0011	6W	3000K	465	180X100X40	Yatay	24	\$14,80
A+G	BL-WA-0012	6W	6500K	465	180X100X40	Yatay	24	\$14,80
A+G	BL-WA-0013	8W	3000K	620	200X100X40	Yatay	24	\$17,90
A+G	BL-WA-0014	8W	6500K	620	200X100X40	Yatay	24	\$17,90

HASTANE  
HOSPITAL

borled®  
by borsan

87

Teknik veri / Datasheet

www.borled.com.tr

# SENSÖRLÜ DUVAR AYDINLATMA ARMATÜRÜ

## SENSOR WALL LIGHTING ARMATURE

### Teknik Özellikler

#### Technical Specifications

Gövde : Plastik  
Body : Plastic

Renk : Siyah, Beyaz, Gri  
Color : Black, White, Gray

IP Derecesi : IP65  
IP Rating : IP65

IK Derecesi : IK03  
IK Rating : IK03

Algılama Mesafesi : 2.5 m  
Detection Distance: 2.5 m

Çalışma Gerilimi : 220-240 V AC  
Operating Voltage Range : 220-240 V AC

Sensör Tipi: P.I.R + FOTOSEL  
Sensor Type: P.I.R + PHOTOCELL



**SENSÖRLÜ DUVAR AYDINLATMA ARMATÜRÜ**  
Modern ve şık doğrusal tasarım, çok renkli Opsiyonel: Beyaz, Siyah, Gri. Kolay gömülü kurulum, kurulum kutusu dahil. Sensörlü gece aydınlatması, IP65 duvar tipi led gömme merdiven lambası.

**SENSOR WALL LIGHTING ARMATURE**  
Modern and stylish linear design, multicolour optional: White, Black, Grey. Easy embedded installation, installation box included. Night lighting with sensor, IP65 wall mounted led recessed stair light.

# SENSÖRLÜ DUVAR AYDINLATMA ARMATÜRÜ

## SENSOR WALL LIGHTING ARMATURE

TURQUALITY®

Enerji Verimliliği Sınıfı Energy Efficiency Class	Ürün Kodu Product Code	Güç (W) Power	Renk Sıcaklığı (K) Color Temperature	Işık Akısı (Lm) Luminous Flux	Boyutlar (WxLxH) mm Dimensions	Kesme Ebatı (Ø) mm Cutting Size	Renk Color	Koli Adeti Quantity in Carton	Fiyat Price
A+G F	BL-SD-0001	1W	3000 K	70	85 × 85 × 25	55	Beyaz White	50	\$8,30
A+G F	BL-SD-0002	1W	4000 K	70	85 × 85 × 25	55	Beyaz White	50	\$8,30
A+G F	BL-SD-0003	1W	6500 K	70	85 × 85 × 25	55	Beyaz White	50	\$8,30
A+G F	BL-SD-0004	1W	3000 K	70	85 × 85 × 25	55	Siyah Black	50	\$8,30
A+G F	BL-SD-0005	1W	4000 K	70	85 × 85 × 25	55	Siyah Black	50	\$8,30
A+G F	BL-SD-0006	1W	6500 K	70	85 × 85 × 25	55	Siyah Black	50	\$8,30
A+G F	BL-SD-0007	1W	3000 K	70	85 × 85 × 25	55	Gri Gray	50	\$8,30
A+G F	BL-SD-0008	1W	6500 K	70	85 × 85 × 25	55	Gri Gray	50	\$8,30
A+G F	BL-SD-0009	1W	3000 K	70	85 × 85 × 25	55	Gri Gray	50	\$8,30



# LED DUVAR VE MERDİVEN APLİKLERİ

## LED WALL AND STAIRCASE LED LIGHTS

### Teknik Özellikler

#### Technical Specifications

Gövde : Plastik  
Body : Plastic

Renk : Nikel, Beyaz, Gri  
Color : Nickel, White, Gray

IP Derecesi : IP20  
IP Rating : IP20

IK Derecesi : IK03  
IK Rating : IK03

Algılama Mesafesi : 2.5 m  
Detection Distance: 2.5 m

Çalışma Gerilimi : 220-240 V AC  
Operating Voltage Range : 220-240 V AC



### LED DUVAR VE MERDİVEN APLİKLERİ

Ev ve iş yerlerinde gece aydınlatmasını dikkat çekici ve farklı bir şekilde yapmak isteyenler için minimal ve şık tasarım, yerden tasarruf sağlayan duvar tipi gömme montaj, montaj kutusu dahildir.

### LED WALL AND STAIRCASE LED LIGHTS

Minimal and stylish design for those who want to make night lighting in their homes and workplaces in a remarkable and different way, space-saving wall type flush mounting, mounting box included.

### LED DUVAR VE MERDİVEN APLİKLERİ

#### LED WALL AND STAIRCASE LED LIGHTS

Enerji Verimliliği Sınıfı Energy Efficiency Class	Ürün Kodu Product Code	Güç (W) Power	Renk Sıcaklığı (K) Color Temperature	Kullanım Tipi Usage Type	Işık Akısı (Lm) Luminous Flux	Boyutlar (WxLxH) mm Dimensions	Renk Color	Koli Adeti Quantity in Carton	Fiyat Price
A+ F	BL-DA-0001	1.5W	3000K	KARE	70	80 x 80 x 60	Krom Chrome	50	\$10,20
A+ F	BL-DA-0002	1.5W	6500K	KARE	70	80 x 80 x 60	Krom Chrome	50	\$10,20
A+ F	BL-DA-0005	2W	3000K	SENSORLU KARE	70	80 x 80 x 60	Krom Chrome	50	\$10,20
A+ F	BL-DA-0006	2W	6500K	SENSORLU KARE	70	80 x 80 x 60	Krom Chrome	50	\$10,20
A+ F	BL-DA-0003	1.5W	3000K	YUVARLAK	70	80 x 80 x 60	Krom Chrome	50	\$10,80
A+ F	BL-DA-0004	1.5W	6500K	YUVARLAK	70	80 x 80 x 60	Krom Chrome	50	\$10,80
A+ F	BL-DA-0007	2W	3000K	SENSORLU YUVARLAK	70	80 x 80 x 60	Krom Chrome	50	\$10,80
A+ F	BL-DA-0008	2W	6500K	SENSORLU YUVARLAK	70	80 x 80 x 60	Krom Chrome	50	\$10,80

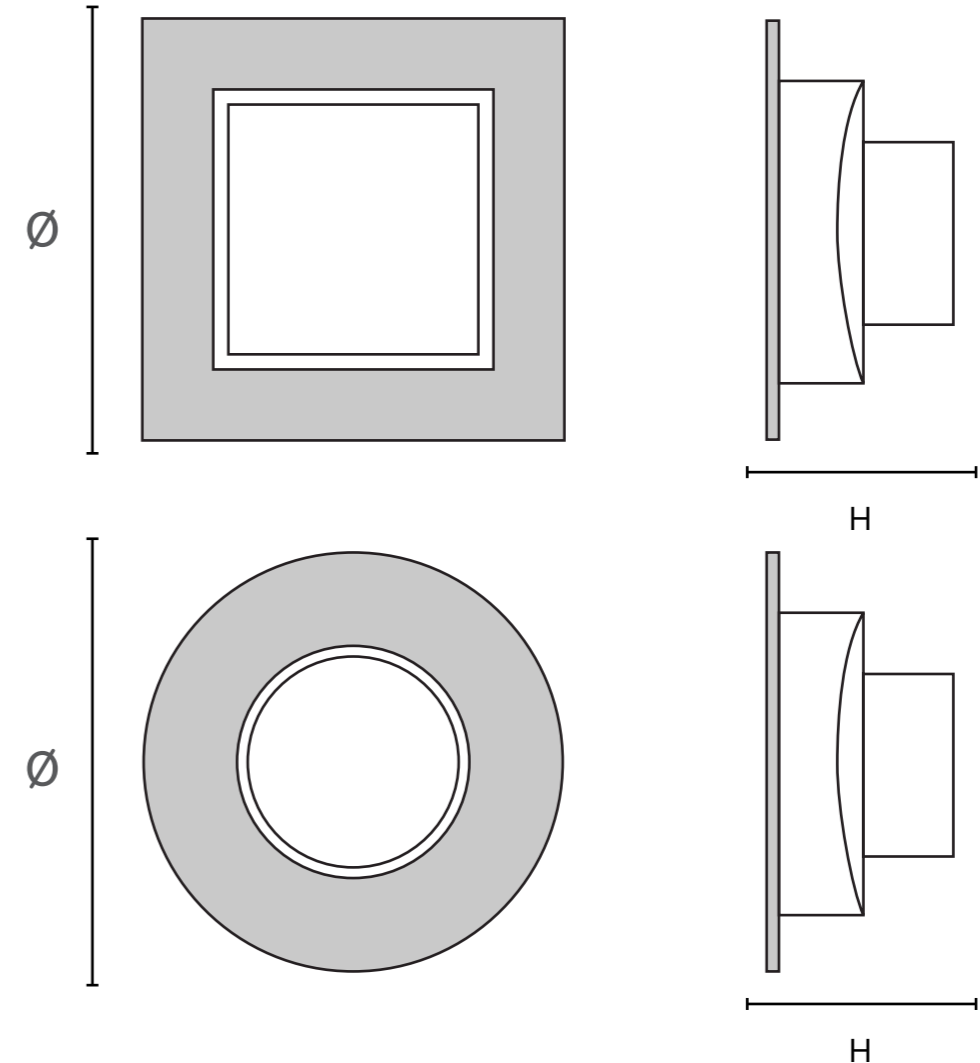

Teknik veri / Datasheet

www.borled.com.tr

## KÜP BAHÇE ARMATÜRÜ (1XE27 DUY) CUBE GARDEN ARMATURE

### Teknik Özellikler Technical Specifications

Gövde : ABS  
Body : ABS

Gerilim : 220 V AC  
Voltage: 220 V AC

IP Derecesi : IP54  
IP Rating : IP54

Çalışma Sıcaklığı : -40°C / 45°C  
Operating Temp. Range : -40°C / 45°C



## KÜP BAHÇE ARMATÜRÜ (KAFESLİ) - (1XE27 DUY) CUBE GARDEN ARMATURE (CAGED)

### Teknik Özellikler Technical Specifications

Gövde : ABS  
Body : ABS

Gerilim : 220 V AC  
Voltage: 220 V AC

IP Derecesi : IP54  
IP Rating : IP54

Çalışma Sıcaklığı : -40°C / 45°C  
Operating Temp. Range : -40°C / 45°C



### KÜP BAHÇE ARMATÜRÜ

Dış mekanlar için IP54 dekoratif bahçe armatürü, dekoratif kübik vurgusu ile ideal aydınlatma çözümleri sunar.

### KÜP BAHÇE ARMATÜRÜ (KAFESLİ)

IP54 dekoratif garden luminaire for outdoor areas, offering ideal lighting solutions with its decorative cubic accent

## KÜP BAHÇE ARMATÜRÜ (1XE27 DUY) CUBE GARDEN ARMATURE

Ürün Kodu Product Code	Renk Color	Boyutlar (WxLxH) mm Dimensions	Gövde Body	Koli Adeti Quantity in Carton	Fiyat Price
BR-BA008	Siyah	220 X 220 X 270	ABS	1	\$38,60

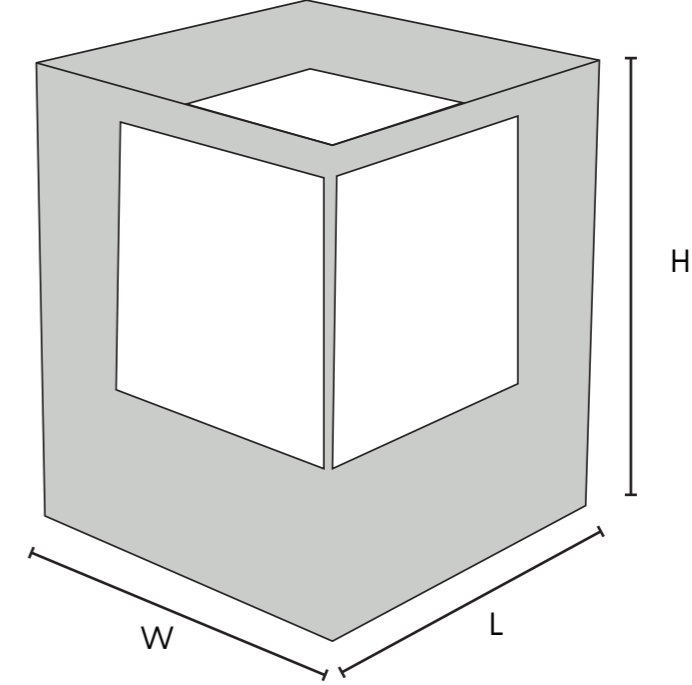

## KÜP BAHÇE ARMATÜRÜ (KAFESLİ) - (1XE27 DUY) CUBE GARDEN ARMATURE (CAGED)

Ürün Kodu Product Code	Renk Color	Boyutlar (WxLxH) mm Dimensions	Gövde Body	Koli Adeti Quantity in Carton	Fiyat Price
BR-BA009	Siyah	220 X 220 X 270	ABS	1	\$38,70

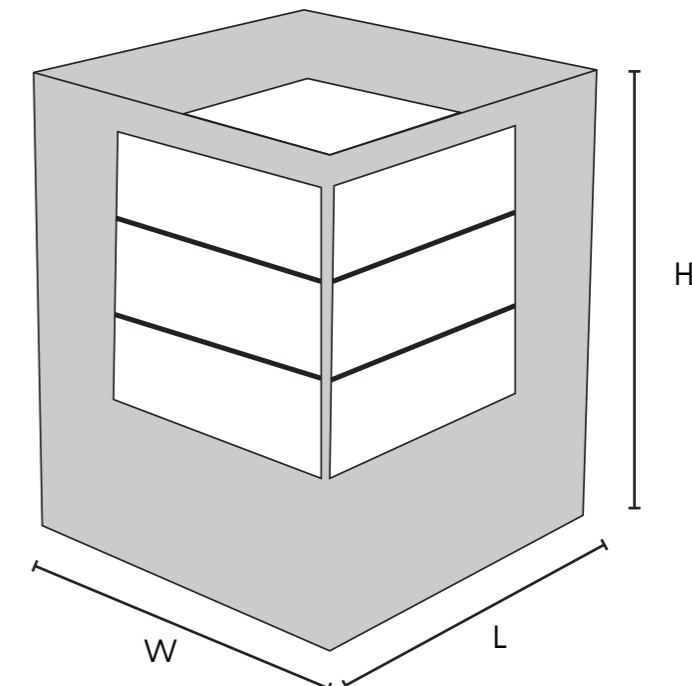

## SOLAR LED BAHÇE ARMATÜRÜ (KARE) SOLAR LED GARDEN ARMATURE (SQUARE)

### Teknik Özellikler Technical Specifications

Gövde : ABS/PC  
Body : ABS/PC

Renk : Siyah  
Color : Black

Kullanım : Tasarruflu/Led Ampul  
Usage : Energy Saving/Led Bulb

IP Derecesi : IP65  
IP Rating : IP65

IK Derecesi : IK07  
IK Rating : IK07

Batarya : LiFePO4 32650-3500 mAh  
Battery : LiFePO4 32650-3500 mAh

Çalışma Sıcaklığı : -15°C / 45°C  
Operating Temp. Range : -15°C / 45°C



## SOLAR LED BAHÇE ARMATÜRÜ (YUVARLAK) SOLAR LED GARDEN ARMATURE (ROUND)

### Teknik Özellikler Technical Specifications

Gövde : ABS/PC  
Body : ABS/PC

Renk : Siyah  
Color : Black

Kullanım : Tasarruflu/Led Ampul  
Usage : Energy Saving/Led Bulb

IP Derecesi : IP65  
IP Rating : IP65

IK Derecesi : IK07  
IK Rating : IK07

Batarya : LiFePO4 32650-3500 mAh  
Battery : LiFePO4 32650-3500 mAh

Çalışma Sıcaklığı : -15°C / 45°C  
Operating Temp. Range : -15°C / 45°C



### SOLAR LED BAHÇE ARMATÜRÜ

Yolları ve bahçe bordürlerini aydınlatın. Etkinlikler, düğünler ve sosyal toplantılar için estetik, çevre dostu ve ekonomik IP 65 dış mekan aydınlatması. Güneşli bir noktaya kolayca sabitleyin ve şarj olmalarını sağlayın. Tam şarjla saatlerce dayanır ve güneş ışığı ile yeniden şarj olur.

### STAKED SOLAR LED FIXTURE

Illuminate paths and garden borders. Aesthetic, environmentally friendly and economical IP 65 outdoor lighting for events, weddings and social gatherings. Easily fix them to a sunny spot and let them recharge. Lasts for hours on a full charge and recharges with sunlight.

## SOLAR LED BAHÇE ARMATÜRÜ (KARE) SOLAR LED GARDEN ARMATURE (SQUARE)

Ürün Kodu Product Code	Güç (W) Power	Batarya Kapasitesi (mAh) Battery Capacity	Renk Sıcaklığı (K) Color Temperature	Işık Akısı (Lm) Luminous Flux	Boyutlar (WxLxH) mm Dimensions	Renk Color	Koli Adeti Quantity in Carton	Fiyat Price
BL-SB-0001	3W	3500	3000 K	220	185 × 185 × 260	Siyah	12	\$56,60
BL-SB-0002	3W	3500	6500 K	220	185 × 185 × 260	Siyah	12	\$56,60
BL-SB-0003	5,5W	3500	3000 K	400	200 × 200 × 260	Siyah	12	\$63,50
BL-SB-0004	5,5W	3500	6500 K	400	200 × 200 × 260	Siyah	12	\$63,50

## SOLAR LED BAHÇE ARMATÜRÜ (YUVARLAK) SOLAR LED GARDEN ARMATURE (ROUND)

Ürün Kodu Product Code	Güç (W) Power	Batarya Kapasitesi (mAh) Battery Capacity	Renk Sıcaklığı (K) Color Temperature	Işık Akısı (Lm) Luminous Flux	Boyutlar (ØxH) mm Dimensions	Renk Color	Koli Adeti Quantity in Carton	Fiyat Price
BL-SB-0005	3W	3500	3000 K	220	185×260	Siyah	12	\$56,60
BL-SB-0006	3W	3500	6500 K	220	185×260	Siyah	12	\$56,60
BL-SB-0007	5,5W	3500	3000 K	400	200×260	Siyah	12	\$63,50
BL-SB-0008	5,5W	3500	6500 K	400	200×260	Siyah	12	\$63,50





# LED YÜKSEK TAVAN ARMATÜR LED HIGH CEILING ARMATURE

## Teknik Özellikler Technical Specifications

Gövde : Alüminyum  
Body : Aluminium

Diffüzör : Polikarbon Cam  
Diffuser : Polycarbon Glass

Renksel Geri Verim : 80  
Color Rendering Index : 80

Sürücü : Philips  
Driver : Philips

IP Derecesi : IP54  
IP Rating : IP54

IK Derecesi : IK03  
IK Rating : IK03

Elektriksel Koruma : Sınıf I  
Electrical Protection : Class I

Çalışma Sıcaklığı : -20°C / 45°C  
Operating Temp. Range : -20°C / 45°C



### LED YÜKSEK TAVAN ARMATÜR

Yüksek tavanlı, erişimi ve bakımı zor olan endüstriyel ve ticari alanları aydınlatmaya yönelik, uzun ömürlü, yüksek enerji tasarrufu ve optimum performans sunar. Estetik, dayanıklılık ve maliyet avantajları sağlar.

### LED HIGH CEILING ARMATURE

It offers long-lasting, high energy saving and optimum performance for illuminating industrial and commercial areas with high ceilings, which are difficult to access and maintain. It provides aesthetic, durability and cost advantages.

# LED YÜKSEK TAVAN ARMATÜR LED HIGH CEILING ARMATURE

Enerji Verimliliği Sınıfı Energy Efficiency Class	Ürün Kodu Product Code	Güç (W) Power	Renk Sıcaklığı (K) Color Temperature	Işık Akısı (Lm) Luminous Flux	Boyutlar (WxLxH) mm Dimensions	Opsiyonlar Options	Koli Adeti Quantity in Carton	Fiyat Price
A+G	BL-Y1-0001	55W	3000 K	6600	132x600x75	-	1	\$117,4
A+G	BL-Y1-0001-3H	55W	3000 K	6600	132x600x75	3 Saat Acil Kit	1	\$188,8
A+G	BL-Y1-0002	55W	4000 K	6600	132x600x75	-	1	\$117,4
A+G	BL-Y1-0002-3H	55W	4000 K	6600	132x600x75	3 Saat Acil Kit	1	\$188,8
A+G	BL-Y1-0003	55W	6500 K	6600	132x600x75	-	1	\$117,4
A+G	BL-Y1-0003-3H	55W	6500 K	6600	132x600x75	3 Saat Acil Kit	1	\$188,8
A+G	BL-Y1-0004	90W	3000 K	10800	132x1000x75	-	1	\$173,5
A+G	BL-Y1-0004-3H	90W	3000 K	10800	132x1000x75	3 Saat Acil Kit	1	\$244,9
A+G	BL-Y1-0005	90W	4000 K	10800	132x1000x75	-	1	\$173,5
A+G	BL-Y1-0005-3H	90W	4000 K	10800	132x1000x75	3 Saat Acil Kit	1	\$244,9
A+G	BL-Y1-0006	90W	6500 K	10800	132x1000x75	-	1	\$173,5
A+G	BL-Y1-0006-3H	90W	6500 K	10800	132x1000x75	3 Saat Acil Kit	1	\$244,9
A+G	BL-Y1-0007	110W	3000 K	13200	132x1200x75	-	1	\$204,1
A+G	BL-Y1-0007-3H	110W	3000 K	13200	132x1200x75	3 Saat Acil Kit	1	\$275,5
A+G	BL-Y1-0008	110W	4000 K	13200	132x1200x75	-	1	\$204,1
A+G	BL-Y1-0008-3H	110W	4000 K	13200	132x1200x75	3 Saat Acil Kit	1	\$275,5
A+G	BL-Y1-0009	110W	6500 K	13200	132x1200x75	-	1	\$204,1
A+G	BL-Y1-0009-3H	110W	6500 K	13200	132x1200x75	3 Saat Acil Kit	1	\$275,5
A+G	BL-Y1-0010	135W	3000 K	16200	132x1500x75	-	1	\$255,1
A+G	BL-Y1-0010-3H	135W	3000 K	16200	132x1500x75	3 Saat Acil Kit	1	\$336,7
A+G	BL-Y1-0011	135W	4000 K	16200	132x1500x75	-	1	\$255,1
A+G	BL-Y1-0011-3H	135W	4000 K	16200	132x1500x75	3 Saat Acil Kit	1	\$336,7
A+G	BL-Y1-0012	135W	6500 K	16200	132x1500x75	-	1	\$255,1
A+G	BL-Y1-0012-3H	135W	6500 K	16200	132x1500x75	3 Saat Acil Kit	1	\$336,7

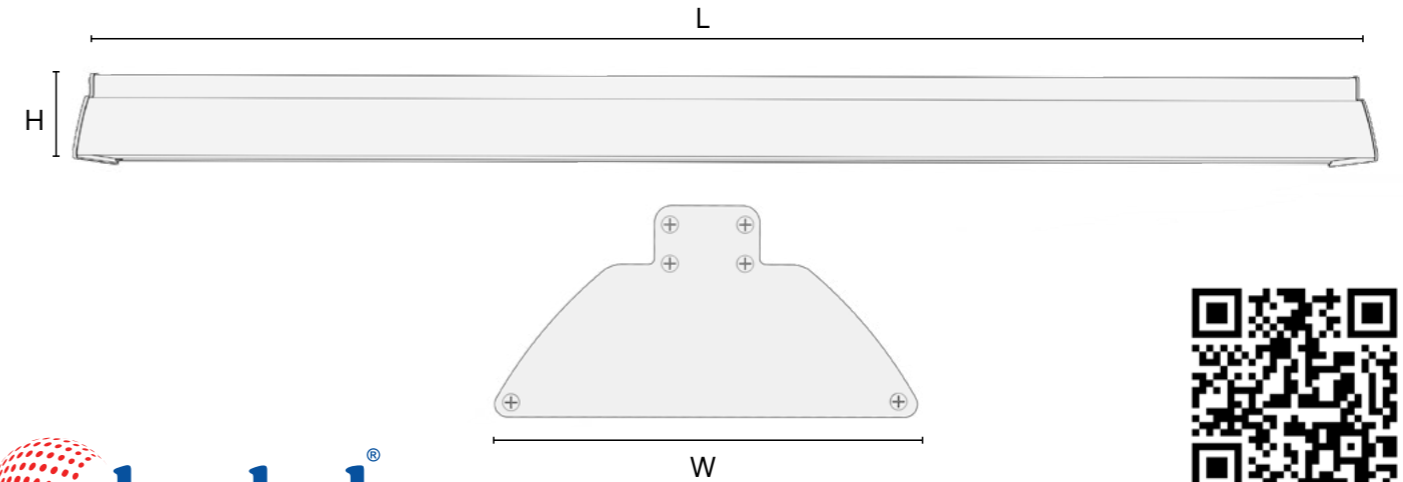

Teknik veri / Datasheet

www.borled.com.tr

# LED LINEER ARMATÜR LED LINEAR ARMATURE

## Teknik Özellikler Technical Specifications

Gövde : Alüminyum  
Body : Aluminium

Diffüzör : Polikarbon Cam  
Diffuser : Polycarbon Glass

Renksel Geri Verim : 80  
Color Rendering Index : 80

IP Derecesi : IP54  
IP Rating : IP54

IK Derecesi : IK03  
IK Rating : IK03

Elektriksel Koruma : Sınıf I  
Electrical Protection : Class I

Çalışma Sıcaklığı : -20°C / 45°C  
Operating Temp. Range : -20°C / 45°C

Sıva Üstü Üründe 1m Askı Teli  
1m Hanger Wire for Surface Mounted Product

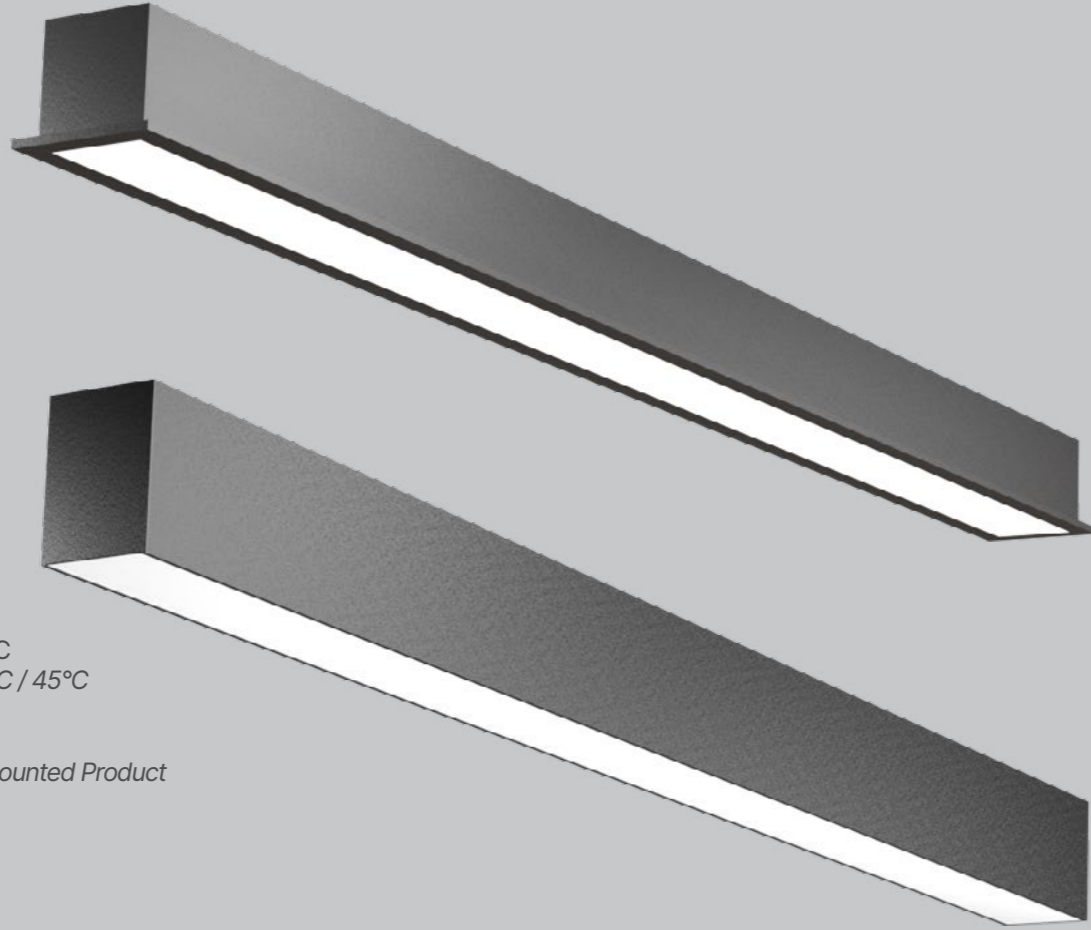

## LED LINEER ARMATÜR

Led lineer armatürler, aydınlatmada üst seviye ışıklandırma, dekoratif ortam ve sağlıklı çalışma performansını sağlamaktadır.

Yüksek kaliteli alüminyum gövde, renk ve boyut alternatifleri sunar.

Led Lineer armatürler, düşük enerji kullanımı ve uzun ömürlü olması nedeniyle son derece verimli çalışır.

Sıva altında, sıva üstünde veya sarkıt aksesuarlar ile rahatlıkla kullanılabilir.

## LED LINEAR ARMATURE

Led linear luminaires provide high level lighting, decorative environment and healthy working performance in lighting.

It offers high quality Aluminium body, color and size alternatives.

Led Linear luminaires will be extremely efficient due to low energy use and being in use.

It can be used under plaster, on surface or with pendant accessories.

## LED LINEER SIVA ALTI ARMATÜR LED LINEAR FLUSH MOUNTED ARMATURE

Enerji Verimliliği Sınıfı Energy Efficiency Class	Ürün Kodu Product Code	Güç (W) Power	Renk Sıcaklığı (K) Color Temperature	Işık Akısı (Lm) Luminous Flux	Boyutlar (WxLxH) mm Dimensions	Koli Adeti Quantity in Carton	Fiyat Price
A+G	BL-L1-1001	15W	4000 K	1800	66 × 650 × 90	1	\$77,20
A+G	BL-L1-1002	15W	6500 K	1800	66 × 650 × 90	1	\$77,20
A+G	BL-L1-1003	20W	4000 K	2400	66 × 650 × 90	1	\$77,20
A+G	BL-L1-1004	20W	6500 K	2400	66 × 650 × 90	1	\$77,20
A+G	BL-L1-1005	30W	4000 K	3600	66 × 1250 × 90	1	\$119,80
A+G	BL-L1-1006	30W	6500 K	3600	66 × 1250 × 90	1	\$119,80
A+G	BL-L1-1007	40W	4000 K	4800	66 × 1250 × 90	1	\$119,80
A+G	BL-L1-1008	40W	6500 K	4800	66 × 1250 × 90	1	\$119,80
A+G	BL-L1-1009	45W	4000 K	5400	66 × 1550 × 90	1	\$130,90
A+G	BL-L1-1010	45W	6500 K	5400	66 × 1550 × 90	1	\$130,90
A+G	BL-L1-1011	50W	4000 K	6000	66 × 1550 × 90	1	\$130,90
A+G	BL-L1-1012	50W	6500 K	6000	66 × 1550 × 90	1	\$130,90

## LED LINEER SIVA ÜSTÜ ARMATÜR LED LINEAR SURFACE MOUNTED ARMATURE

Enerji Verimliliği Sınıfı Energy Efficiency Class	Ürün Kodu Product Code	Güç (W) Power	Renk Sıcaklığı (K) Color Temperature	Işık Akısı (Lm) Luminous Flux	Boyutlar (WxLxH) mm Dimensions	Koli Adeti Quantity in Carton	Fiyat Price
A+G	BL-L1-2001	15W	4000 K	1800	66 × 600 × 90	1	\$89,80
A+G	BL-L1-2002	15W	6500 K	1800	66 × 600 × 90	1	\$89,80
A+G	BL-L1-2003	20W	4000 K	2400	66 × 600 × 90	1	\$89,80
A+G	BL-L1-2004	20W	6500 K	2400	66 × 600 × 90	1	\$89,80
A+G	BL-L1-2005	30W	4000 K	3600	66 × 1200 × 90	1	\$173,90
A+G	BL-L1-2006	30W	6500 K	3600	66 × 1200 × 90	1	\$173,90
A+G	BL-L1-2007	40W	4000 K	4800	66 × 1200 × 90	1	\$179,10
A+G	BL-L1-2008	40W	6500 K	4800	66 × 1200 × 90	1	\$179,10
A+G	BL-L1-2009	45W	4000 K	5400	66 × 1500 × 90	1	\$195,10
A+G	BL-L1-2010	45W	6500 K	5400	66 × 1500 × 90	1	\$195,10
A+G	BL-L1-2011	50W	4000 K	6000	66 × 1500 × 90	1	\$195,10
A+G	BL-L1-2012	50W	6500 K	6000	66 × 1500 × 90	1	\$195,10

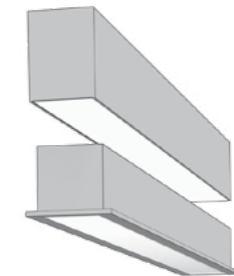
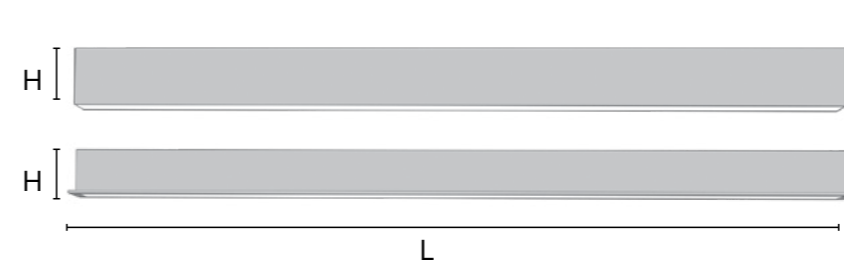

Teknik veri / Datasheet

www.borled.com.tr

# LENSLİ LINEER ARMATÜR

## LINEAR ARMATURE WITH LENS

### Teknik Özellikler

#### Technical Specifications

Gövde : Alüminyum  
Body : Aluminium

Diffüzör : Polikarbon Cam  
Diffuser : Polycarbon Glass

Renksel Geri Verim : 80  
Color Rendering Index : 80

IP Derecesi : IP54  
IP Rating : IP54

IK Derecesi : IK03  
IK Rating : IK03

Elektriksel Koruma : Sınıf I  
Electrical Protection : Class I

Çalışma Sıcaklığı : -20°C / 45°C  
Operating Temp. Range : -20°C / 45°C

Sıva Üstü Üründe 1m Askı Teli  
1m Hanger Wire for Surface Mounted Product

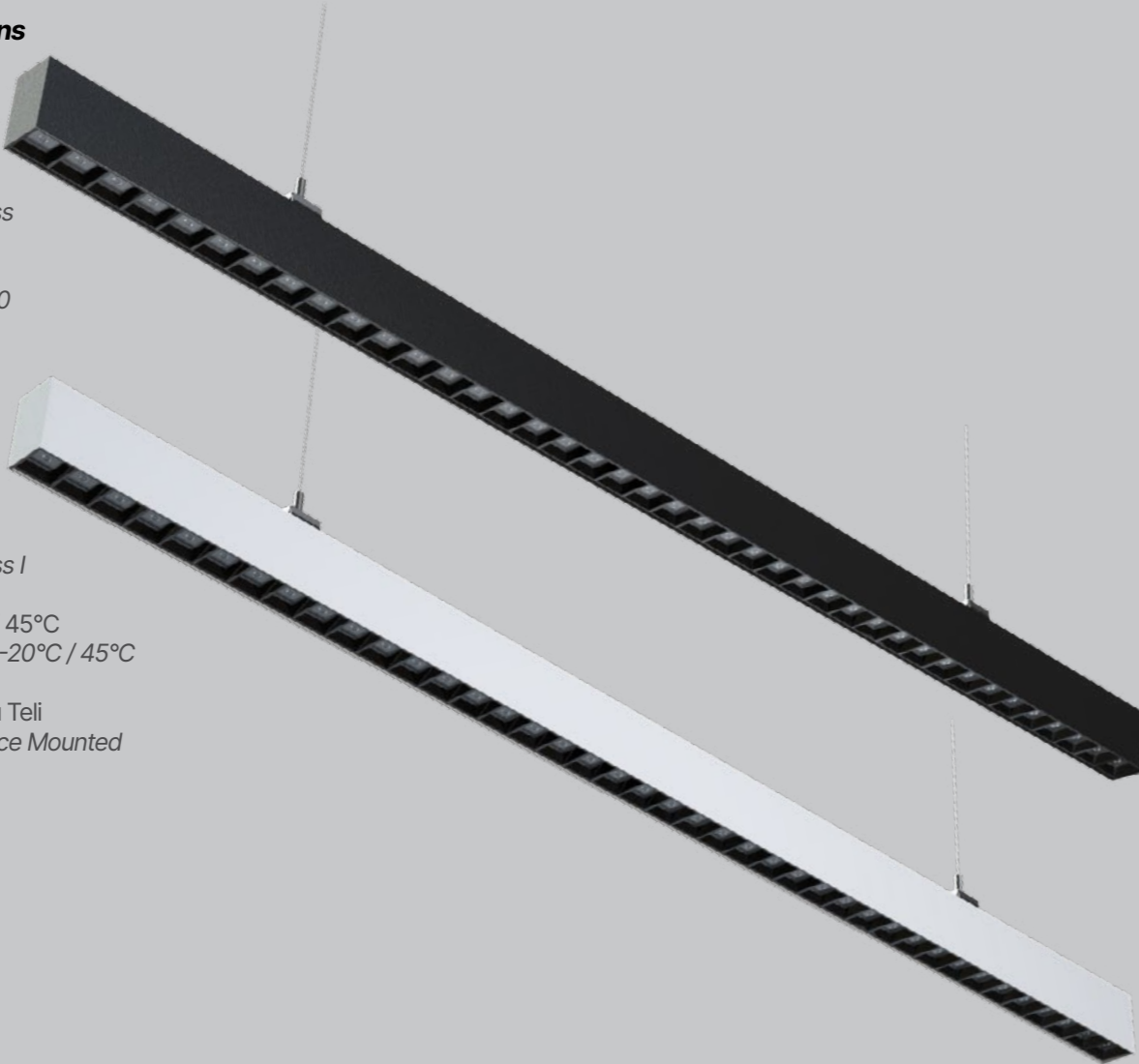

### LENSLİ LINEER ARMATÜR

Led lineer armatürler, aydınlatmada üst seviye ışıklandırma, dekoratif ortam ve sağlıklı çalışma performansı sağlamaktadır.

Yüksek kaliteli alüminyum gövde, renk ve boyut alternatifleri sunar.

Led Lineer armatürler, düşük enerji kullanımı ve uzun ömürlü olması nedeniyle son derece verimli çalışır.

Sıva altında, sıva üstünde veya sarkıt aksesuarlar ile rahatlıkla kullanılabilir.

### LINEAR ARMATURE WITH LENS

Led linear luminaires provide high level lighting, decorative environment and healthy working performance in lighting.

It offers high quality Aluminium body, color and size alternatives.

Led Linear luminaires will be extremely efficient due to low energy use and being in use.

It can be used under plaster, on surface or with pendant accessories.

# LENSLİ LED LINEER SIVA ALTI ARMATÜR

## LED LINEAR FLUSH MOUNTED ARMATURE WITH LENS

Enerji Verimliliği Sınıfı Energy Efficiency Class	Ürün Kodu Product Code	Güç (W) Power	Renk Sıcaklığı (K) Color Temperature	Işık Akısı (Lm) Luminous Flux	Boyutlar (WxLxH) mm Dimensions	Renk Color	Koli Adeti Quantity in Carton	Fiyat Price
A F	BL-L2-1001	25W	4000 K	1750	Siyah	35 × 670 × 70	1	\$56,40
A F	BL-L2-1002	25W	6500 K	1750	Siyah	35 × 670 × 70	1	\$56,40
A F	BL-L2-1003	40W	4000 K	2800	Siyah	35 × 1070 × 70	1	\$90,50
A F	BL-L2-1004	40W	6500 K	2800	Siyah	35 × 1070 × 70	1	\$90,50
A F	BL-L2-1011	25W	4000 K	1750	Beyaz	35 × 670 × 70	1	\$56,40
A F	BL-L2-1012	25W	6500 K	1750	Beyaz	35 × 670 × 70	1	\$56,40
A F	BL-L2-1013	40W	4000 K	2800	Beyaz	35 × 1070 × 70	1	\$90,50
A F	BL-L2-1014	40W	6500 K	2800	Beyaz	35 × 1070 × 70	1	\$90,50

# LENSLİ LED LINEER SIVA ÜSTÜ ARMATÜR

## LED LINEAR SURFACE MOUNTED ARMATURE WITH LENS

Enerji Verimliliği Sınıfı Energy Efficiency Class	Ürün Kodu Product Code	Güç (W) Power	Renk Sıcaklığı (K) Color Temperature	Işık Akısı (Lm) Luminous Flux	Boyutlar (WxLxH) mm Dimensions	Renk Color	Koli Adeti Quantity in Carton	Fiyat Price
A F	BL-L2-2001	25W	4000 K	1750	Siyah	35 × 670 × 70	1	\$61,60
A F	BL-L2-2002	25W	6500 K	1750	Siyah	35 × 670 × 70	1	\$61,60
A F	BL-L2-2003	40W	4000 K	2800	Siyah	35 × 1070 × 70	1	\$92,30
A F	BL-L2-2004	40W	6500 K	2800	Siyah	35 × 1070 × 70	1	\$92,30
A F	BL-L2-2011	25W	4000 K	1750	Beyaz	35 × 670 × 70	1	\$61,60
A F	BL-L2-2012	25W	6500 K	1750	Beyaz	35 × 670 × 70	1	\$61,60
A F	BL-L2-2013	40W	4000 K	2800	Beyaz	35 × 1070 × 70	1	\$92,30
A F	BL-L2-2014	40W	6500 K	2800	Beyaz	35 × 1070 × 70	1	\$92,30

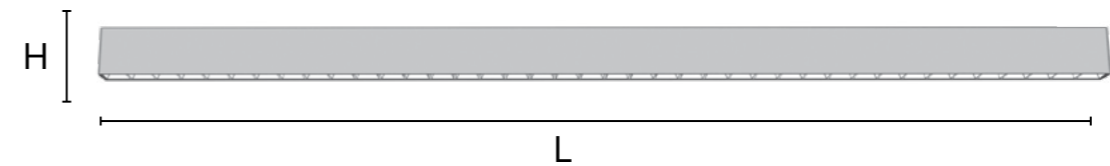
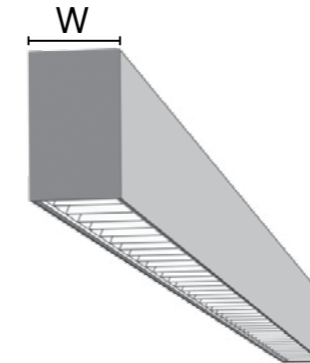

Teknik veri / Datasheet

www.borled.com.tr

# LED LEVEL ETANJ ARMATÜR

## LED LEVEL WATERPROOF ARMATURE

### Teknik Özellikler

#### Technical Specifications

Gövde : Polikarbonat  
Body : Polycarbonate

Gövde Renkleri : Gri  
Body Colors : Grey

Kapak : Polikarbonat  
Cover : Polycarbonate

Kapak Rengi : Gri  
Cover Color : Grey

Renksel Geri Verim : 80  
Color Rendering Index : 80

IP Derecesi : IP65  
IP Rating : IP65

IK Derecesi : IK09  
IK Rating : IK09

Elektriksel Koruma : Sınıf II  
Electrical Protection : Class II

Çalışma Sıcaklığı : -20°C / 45°C  
Operating Temp. Range : -20°C / 45°C

3000 K OPSİYONDUR  
L : 1500 MM OPSİYONU VARDIR

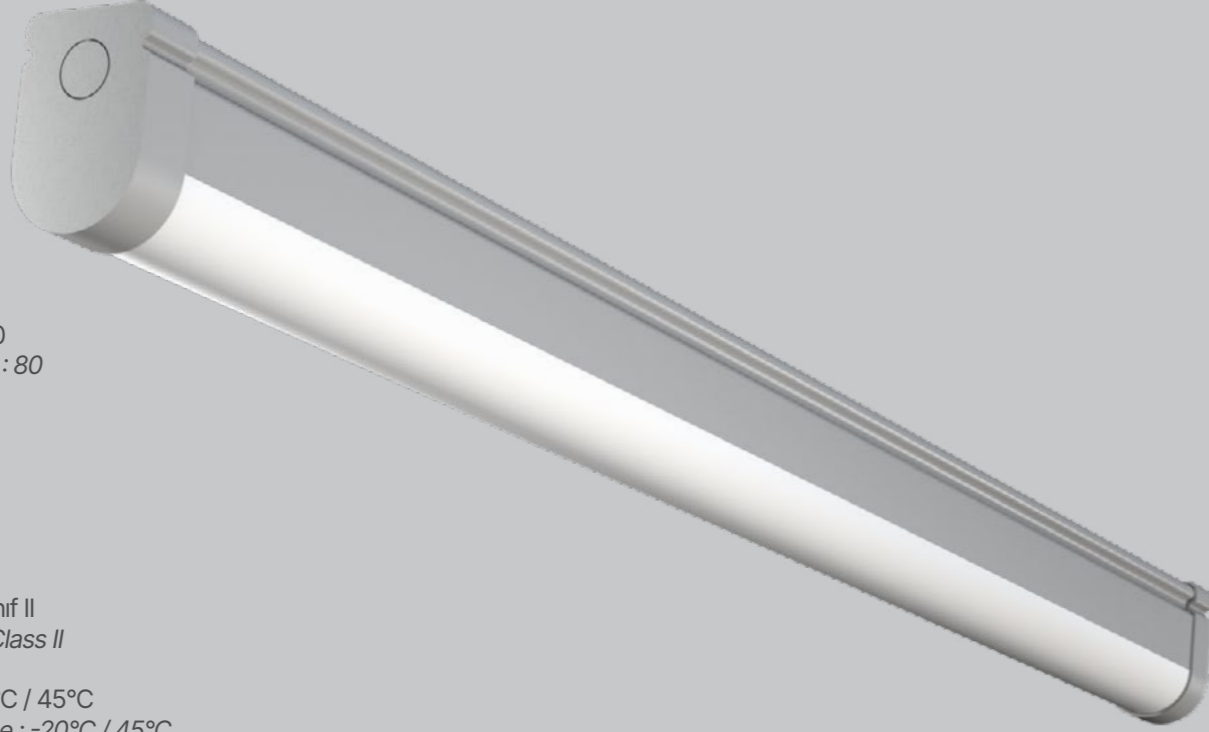

### LED LEVEL ETANJ ARMATÜR

IP65 koruma standartlarında polikarbon gövde ve difüzör yapısı; neme, toza, doğrudan su ve darbelere karşı etkindir. Led aydınlatma ve difüzör tasarımı, her türlü alanda yüksek ışık verimliliği ve konforlu görüş sağlar. Kolay montaj ve bakım imkanları sunar.

### LED LEVEL WATERPROOF ARMATURE

Polycarbonate body and diffuser structure in IP65 protection standards; It is effective against moisture, dust, direct water and impacts. Led lighting and diffuser design provide high luminous efficiency and comfortable vision in all kinds of areas. It offers easy installation and maintenance opportunities.

# LED LEVEL ETANJ ARMATÜR

## LED LEVEL WATERPROOF ARMATURE

TURQUALITY®

Enerji Verimliliği Sınıfı Energy Efficiency Class	Ürün Kodu Product Code	Güç (W) Power	Renk Sıcaklığı (K) Color Temperature	Işık Akısı (Lm) Luminous Flux	Boyutlar (WxLxH) mm Dimensions	Opsiyonlar Options	Koli Adeti Quantity in Carton	Fiyat Price
A F G	BL-E1-0009	15W	4000 K	1350	44 × 600 × 64	-	12	\$18,80
A F G	BL-E1-0013	15W	6500 K	1350	44 × 600 × 64	-	12	\$18,80
A F G	BL-E1-0009-RS	15W	4000 K	1350	44 × 600 × 64	Radar Sensörlü	12	\$30,10
A F G	BL-E1-0013-RS	15W	6500 K	1350	44 × 600 × 64	Radar Sensörlü	12	\$30,10
A F G	BL-E1-0009-3H	15W	4000 K	1350	44 × 600 × 64	3 Saat Acil Kit	12	\$53,10
A F G	BL-E1-0013-3H	15W	6500 K	1350	44 × 600 × 64	3 Saat Acil Kit	12	\$53,10
A F G	BL-E1-0009-RS-3H	15W	4000 K	1350	44 × 600 × 64	Radar Sensörlü 3 Saat Acil Kit	12	\$56,50
A F G	BL-E1-0013-RS-3H	15W	6500 K	1350	44 × 600 × 64	Radar Sensörlü 3 Saat Acil Kit	12	\$56,50
A F G	BL-E1-0011	30W	4000 K	2700	44 × 1200 × 64	-	12	\$35,30
A F G	BL-E1-0015	30W	6500 K	2700	44 × 1200 × 64	-	12	\$35,30
A F G	BL-E1-0011-RS	30W	4000 K	2700	44 × 1200 × 64	Radar Sensörlü	12	\$70,30
A F G	BL-E1-0015-RS	30W	6500 K	2700	44 × 1200 × 64	Radar Sensörlü	12	\$70,30
A F G	BL-E1-0011-3H	30W	4000 K	2700	44 × 1200 × 64	3 Saat Acil Kit	12	\$70,30
A F G	BL-E1-0015-3H	30W	6500 K	2700	44 × 1200 × 64	3 Saat Acil Kit	12	\$70,30
A F G	BL-E1-0011-RS-3H	30W	4000 K	2700	44 × 1200 × 64	Radar Sensörlü 3 Saat Acil Kit	12	\$93,70
A F G	BL-E1-0015-RS-3H	30W	6500 K	2700	44 × 1200 × 64	Radar Sensörlü 3 Saat Acil Kit	12	\$93,70



Teknik veri / Datasheet

www.borled.com.tr

HASTANE  
HOSPITAL

borled®  
by borsan

103

# LED LEVEL ETANJ ARMATÜR TSE

## LED LEVEL WATERPROOF ARMATURE TSE

### Teknik Özellikler

#### Technical Specifications

Gövde : Polikarbonat  
Body : Polycarbonate

Gövde Renkleri : Gri  
Body Colors : Grey

Kapak : Polikarbonat  
Cover : Polycarbonate

Kapak Rengi : Gri  
Cover Color : Grey

Renksel Geri Verim : 80  
Color Rendering Index : 80

IP Derecesi : IP65  
IP Rating : IP65

IK Derecesi : IK09  
IK Rating : IK09

Elektriksel Koruma : Sınıf II  
Electrical Protection : Class II

Çalışma Sıcaklığı : -20°C / 45°C  
Operating Temp. Range : -20°C / 45°C

3000 K OPSİYONDUR  
L : 1500 MM OPSİYONU VARDIR

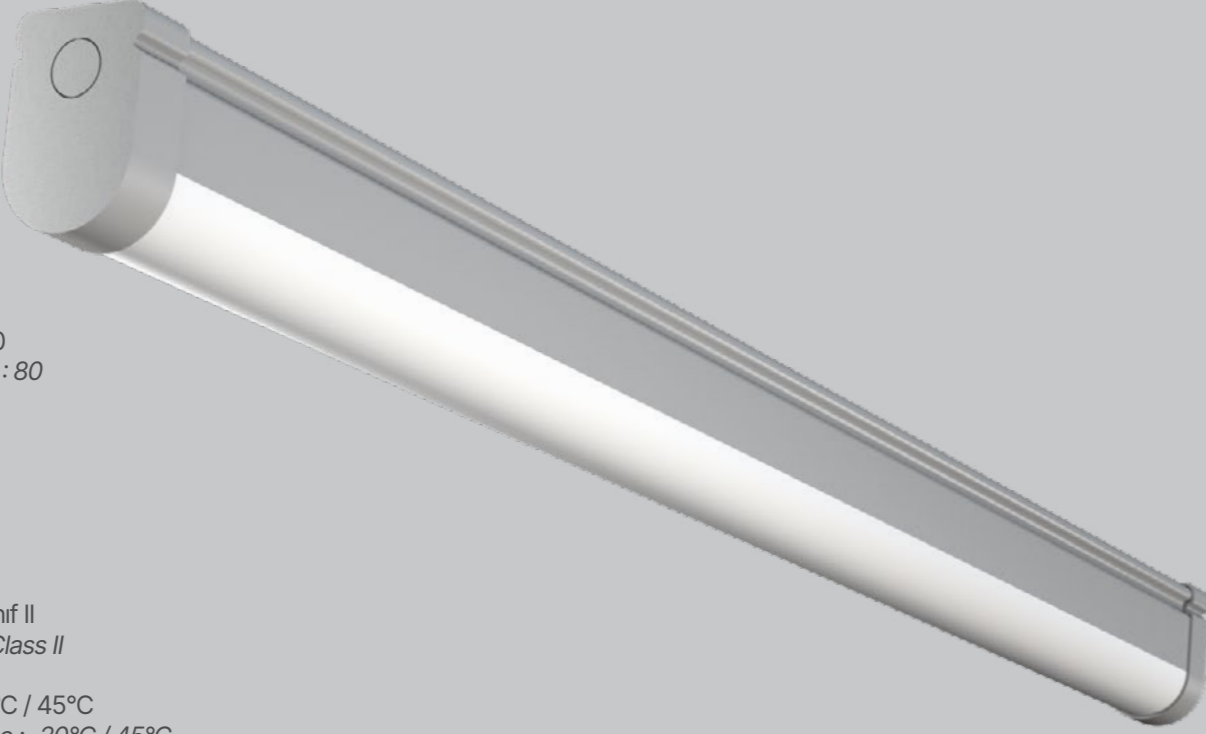

### LED LEVEL ETANJ ARMATÜR TSE

IP65 koruma standartlarında polikarbon gövde ve difüzör yapısı; neme, toza, doğrudan su ve darbelere karşı etkindir. Led aydınlatma ve difüzör tasarımı, her türlü alanda yüksek ışık verimliliği ve konforlu görüş sağlar. Kolay montaj ve bakım imkanları sunar.

### LED LEVEL WATERPROOF ARMATURE TSE

Polycarbonate body and diffuser structure in IP65 protection standards; It is effective against moisture, dust, direct water and impacts. Led lighting and diffuser design provide high luminous efficiency and comfortable vision in all kinds of areas. It offers easy installation and maintenance opportunities.

# LED LEVEL ETANJ ARMATÜR TSE

## LED LEVEL WATERPROOF ARMATURE TSE

Enerji Verimliliği Sınıfı Energy Efficiency Class	Ürün Kodu Product Code	Güç (W) Power	Renk Sıcaklığı (K) Color Temperature	Işık Akısı (Lm) Luminous Flux	Boyutlar (WxLxH) mm Dimensions	Opsiyonlar Options	Koli Adeti Quantity in Carton	Fiyat Price
A F G	BLT-E1-0009	15W	4000 K	1500	44 × 600 × 64	-	12	\$25,30
A F G	BLT-E1-0013	15W	6500 K	1500	44 × 600 × 64	-	12	\$25,30
A F G	BLT-E1-0009-RS	15W	4000 K	1500	44 × 600 × 64	Radar Sensörlü	12	\$60,80
A F G	BLT-E1-0013-RS	15W	6500 K	1500	44 × 600 × 64	Radar Sensörlü	12	\$60,80
A F G	BLT-E1-0009-3H	15W	4000 K	1500	44 × 600 × 64	3 Saat Acil Kit	12	\$58,20
A F G	BLT-E1-0013-3H	15W	6500 K	1500	44 × 600 × 64	3 Saat Acil Kit	12	\$58,20
A F G	BLT-E1-0009-RS-3H	15W	4000 K	1500	44 × 600 × 64	Radar Sensörlü 3 Saat Acil Kit	12	\$93,10
A F G	BLT-E1-0013-RS-3H	15W	6500 K	1500	44 × 600 × 64	Radar Sensörlü 3 Saat Acil Kit	12	\$93,10
A F G	BLT-E1-0011	30W	4000 K	3000	44 × 1200 × 64	-	12	\$35,10
A F G	BLT-E1-0015	30W	6500 K	3000	44 × 1200 × 64	-	12	\$35,10
A F G	BLT-E1-0011-RS	30W	4000 K	3000	44 × 1200 × 64	Radar Sensörlü	12	\$70,60
A F G	BLT-E1-0015-RS	30W	6500 K	3000	44 × 1200 × 64	Radar Sensörlü	12	\$70,60
A F G	BLT-E1-0011-3H	30W	4000 K	3000	44 × 1200 × 64	3 Saat Acil Kit	12	\$69,40
A F G	BLT-E1-0015-3H	30W	6500 K	3000	44 × 1200 × 64	3 Saat Acil Kit	12	\$69,40
A F G	BLT-E1-0011-RS-3H	30W	4000 K	3000	44 × 1200 × 64	Radar Sensörlü 3 Saat Acil Kit	12	\$104,00
A F G	BLT-E1-0015-RS-3H	30W	6500 K	3000	44 × 1200 × 64	Radar Sensörlü 3 Saat Acil Kit	12	\$104,00



Teknik veri / Datasheet  
www.borled.com.tr

# LED ELIPS ETANJ ARMATÜR

## LED ELIPS WATERPROOF ARMATURE

### Teknik Özellikler

#### Technical Specifications

Gövde : Polikarbonat  
Body : Polycarbonate

Gövde Renkleri : Gri  
Body Colors : Grey

Kapak : Polikarbonat  
Cover : Polycarbonate

Kapak Rengi : Gri  
Cover Color : Grey

Renksel Geri Verim : 80  
Color Rendering Index : 80

IP Derecesi : IP65  
IP Rating : IP65

IK Derecesi : IK09  
IK Rating : IK09

Elektriksel Koruma : Sınıf II  
Electrical Protection : Class II

Çalışma Sıcaklığı : -20°C / 45°C  
Operating Temp. Range : -20°C / 45°C

3000 K OPSİYONDUR  
L : 1500 MM OPSİYONU VARDIR

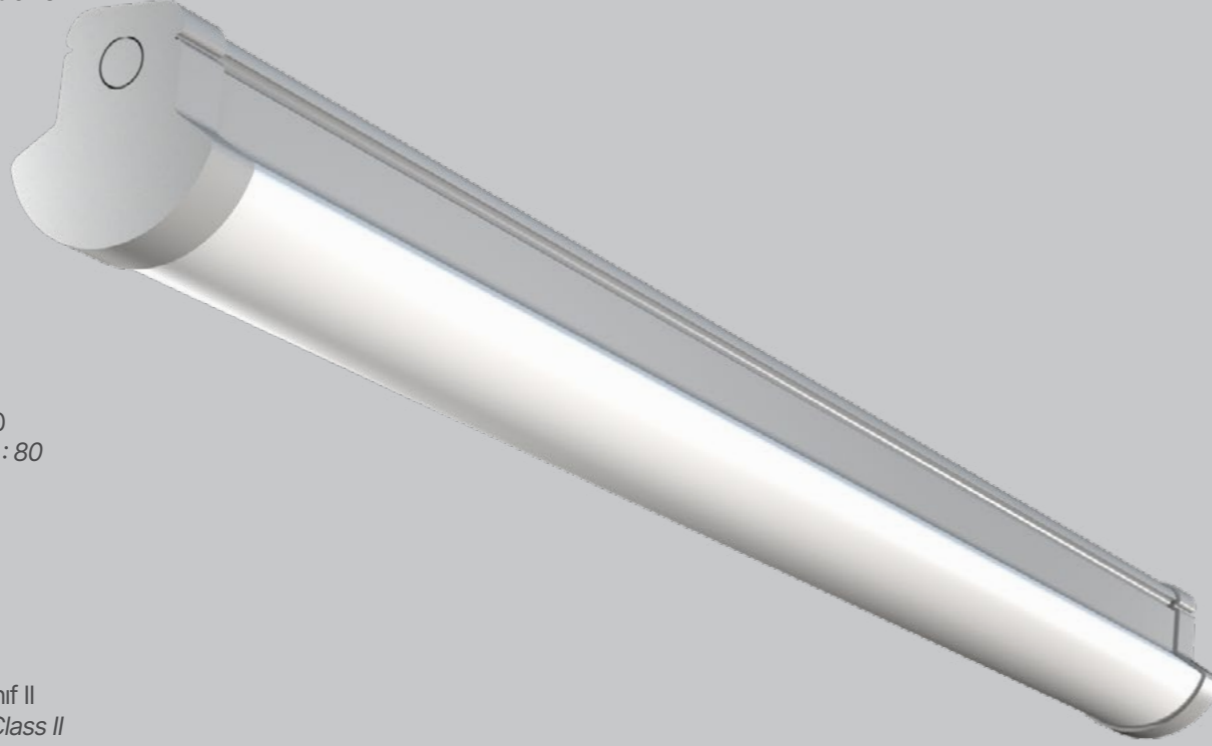

### LED ELIPS ETANJ ARMATÜR

IP65 koruma standartlarında polikarbon gövde ve difüzör yapısı; neme, toza, doğrudan su ve darbelere karşı etkindir. Led aydınlatma ve difüzör tasarımı, her türlü alanda yüksek ışık verimliliği ve konforlu görüş sağlar. Kolay montaj ve bakım imkanları sunar.

### LED ELIPS WATERPROOF ARMATURE

Polycarbonate body and diffuser structure in IP65 protection standards; It is effective against moisture, dust, direct water and impacts. Led lighting and diffuser design provide high luminous efficiency and comfortable vision in all kinds of areas. It offers easy installation and maintenance opportunities.

# LED ELIPS ETANJ ARMATÜR

## LED ELIPS WATERPROOF ARMATURE

TURQUALITY®

Enerji Verimliliği Sınıfı Energy Efficiency Class	Ürün Kodu Product Code	Güç (W) Power	Renk Sıcaklığı (K) Color Temperature	Işık Akısı (Lm) Luminous Flux	Boyutlar (WxLxH) mm Dimensions	Opsiyonlar Options	Koli Adeti Quantity in Carton	Fiyat Price
A F	BL-E1-0010	20W	4000 K	1800	75 × 600 × 75	-	12	\$19,90
A F	BL-E1-0014	20W	6500 K	1800	75 × 600 × 75	-	12	\$19,90
A F	BL-E1-0010-RS	20W	4000 K	1800	75 × 600 × 75	Radar Sensörlü	12	\$31,00
A F	BL-E1-0014-RS	20W	6500 K	1800	75 × 600 × 75	Radar Sensörlü	12	\$31,00
A F	BL-E1-0010-3H	20W	4000 K	1800	75 × 600 × 75	3 Saat Acil Kit	12	\$54,50
A F	BL-E1-0014-3H	20W	6500 K	1800	75 × 600 × 75	3 Saat Acil Kit	12	\$54,50
A F	BL-E1-0010-RS-3H	20W	4000 K	1800	75 × 600 × 75	Radar Sensörlü 3 Saat Acil Kit	12	\$62,00
A F	BL-E1-0014-RS-3H	20W	6500 K	1800	75 × 600 × 75	Radar Sensörlü 3 Saat Acil Kit	12	\$62,00
A F	BL-E1-0012	40W	4000 K	3600	75 × 1200 × 75	-	12	\$32,30
A F	BL-E1-0016	40W	6500 K	3600	75 × 1200 × 75	-	12	\$32,30
A F	BL-E1-0012-3H	40W	4000 K	3600	75 × 1200 × 75	Radar Sensörlü	12	\$67,80
A F	BL-E1-0016-3H	40W	6500 K	3600	75 × 1200 × 75	Radar Sensörlü	12	\$67,80
A F	BL-E1-0012-RS	40W	4000 K	3600	75 × 1200 × 75	3 Saat Acil Kit	12	\$58,20
A F	BL-E1-0016-RS	40W	6500 K	3600	75 × 1200 × 75	3 Saat Acil Kit	12	\$58,20
A F	BL-E1-0012-RS-3H	40W	4000 K	3600	75 × 1200 × 75	Radar Sensörlü 3 Saat Acil Kit	12	\$105,50
A F	BL-E1-0016-RS-3H	40W	6500 K	3600	75 × 1200 × 75	Radar Sensörlü 3 Saat Acil Kit	12	\$105,50

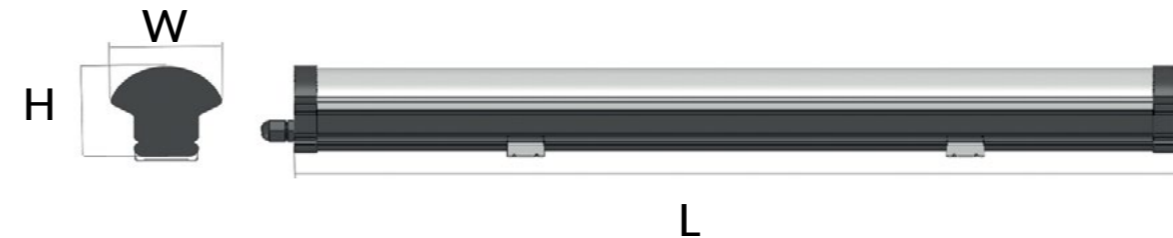

Teknik veri / Datasheet

www.borled.com.tr

HASTANE  
HOSPITAL

borled®  
by borsan

107

# LED ELIPS ETANJ ARMATÜR TSE

## LED ELIPS WATERPROOF ARMATURE TSE

### Teknik Özellikler

#### Technical Specifications

Gövde : Polikarbonat  
Body : Polycarbonate

Gövde Renkleri : Gri  
Body Colors : Grey

Kapak : Polikarbonat  
Cover : Polycarbonate

Kapak Rengi : Gri  
Cover Color : Grey

Renksel Geri Verim : 80  
Color Rendering Index : 80

IP Derecesi : IP65  
IP Rating : IP65

IK Derecesi : IK09  
IK Rating : IK09

Elektriksel Koruma : Sınıf II  
Electrical Protection : Class II

Çalışma Sıcaklığı : -20°C / 45°C  
Operating Temp. Range : -20°C / 45°C

3000 K OPSİYONDUR  
L : 1500 MM OPSİYONU VARDIR

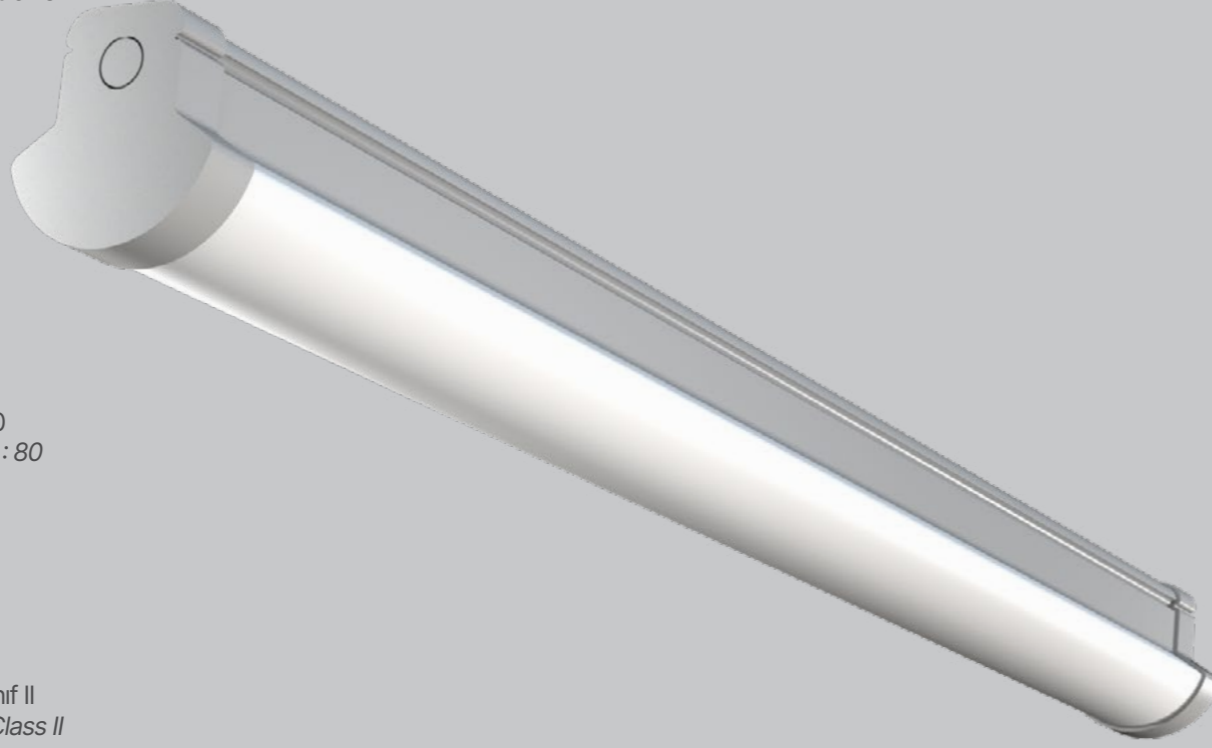

### LED ELIPS ETANJ ARMATÜR TSE

IP65 koruma standartlarında polikarbon gövde ve difüzör yapısı; neme, toza, doğrudan su ve darbelere karşı etkindir. Led aydınlatma ve difüzör tasarımı, her türlü alanda yüksek ışık verimliliği ve konforlu görüş sağlar. Kolay montaj ve bakım imkanları sunar.

### LED ELIPS WATERPROOF ARMATURE TSE

Polycarbonate body and diffuser structure in IP65 protection standards; It is effective against moisture, dust, direct water and impacts. Led lighting and diffuser design provide high luminous efficiency and comfortable vision in all kinds of areas. It offers easy installation and maintenance opportunities.

# LED ELIPS ETANJ ARMATÜR TSE

## LED ELIPS WATERPROOF ARMATURE TSE

Enerji Verimliliği Sınıfı Energy Efficiency Class	Ürün Kodu Product Code	Güç (W) Power	Renk Sıcaklığı (K) Color Temperature	Işık Akısı (Lm) Luminous Flux	Boyutlar (WxLxH) mm Dimensions	Opsiyonlar Options	Koli Adeti Quantity in Carton	Fiyat Price
A F G	BLT-E1-0010	20W	4000 K	2000	75 × 600 × 75	-	12	\$26,50
A F G	BLT-E1-0014	20W	6500 K	2000	75 × 600 × 75	-	12	\$26,50
A F G	BLT-E1-0010-RS	20W	4000 K	2000	75 × 600 × 75	Radar Sensörlü	12	\$61,80
A F G	BLT-E1-0014-RS	20W	6500 K	2000	75 × 600 × 75	Radar Sensörlü	12	\$61,80
A F G	BLT-E1-0010-3H	20W	4000 K	2000	75 × 600 × 75	3 Saat Acil Kit	12	\$59,40
A F G	BLT-E1-0014-3H	20W	6500 K	2000	75 × 600 × 75	3 Saat Acil Kit	12	\$59,40
A F G	BLT-E1-0010-RS-3H	20W	4000 K	2000	75 × 600 × 75	Radar Sensörlü 3 Saat Acil Kit	12	\$94,10
A F G	BLT-E1-0014-RS-3H	20W	6500 K	2000	75 × 600 × 75	Radar Sensörlü 3 Saat Acil Kit	12	\$94,10
A F G	BLT-E1-0012	40W	4000 K	4000	75 × 1200 × 75	-	12	\$37,00
A F G	BLT-E1-0016	40W	6500 K	4000	75 × 1200 × 75	-	12	\$37,00
A F G	BLT-E1-0012-3H	40W	4000 K	4000	75 × 1200 × 75	Radar Sensörlü	12	\$71,00
A F G	BLT-E1-0016-3H	40W	6500 K	4000	75 × 1200 × 75	Radar Sensörlü	12	\$71,00
A F G	BLT-E1-0012-RS	40W	4000 K	4000	75 × 1200 × 75	3 Saat Acil Kit	12	\$73,20
A F G	BLT-E1-0016-RS	40W	6500 K	4000	75 × 1200 × 75	3 Saat Acil Kit	12	\$73,20
A F G	BLT-E1-0012-RS-3H	40W	4000 K	4000	75 × 1200 × 75	Radar Sensörlü 3 Saat Acil Kit	12	\$106,70
A F G	BLT-E1-0016-RS-3H	40W	6500 K	4000	75 × 1200 × 75	Radar Sensörlü 3 Saat Acil Kit	12	\$106,70

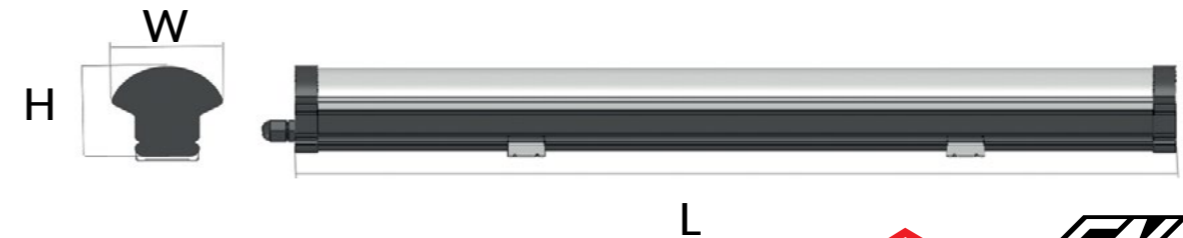

Teknik veri / Datasheet

www.borled.com.tr

# KÖŞE ETANJ CORNER ETANJ

## Teknik Özellikler Technical Specifications



Gövde : Polikarbonat  
Body : Polycarbonate

Gövde Renkleri : Gri  
Body Colors : Grey

Kapak : Polikarbonat  
Cover : Polycarbonate

Kapak Rengi : Gri  
Cover Color : Grey

Renksel Geri Verim : 80  
Color Rendering Index : 80

IP Derecesi : IP65  
IP Rating : IP65

IK Derecesi : IK09  
IK Rating : IK09

Elektriksel Koruma : Sınıf II  
Electrical Protection : Class II

Çalışma Sıcaklığı : -20°C / 45°C  
Operating Temp. Range : -20°C / 45°C

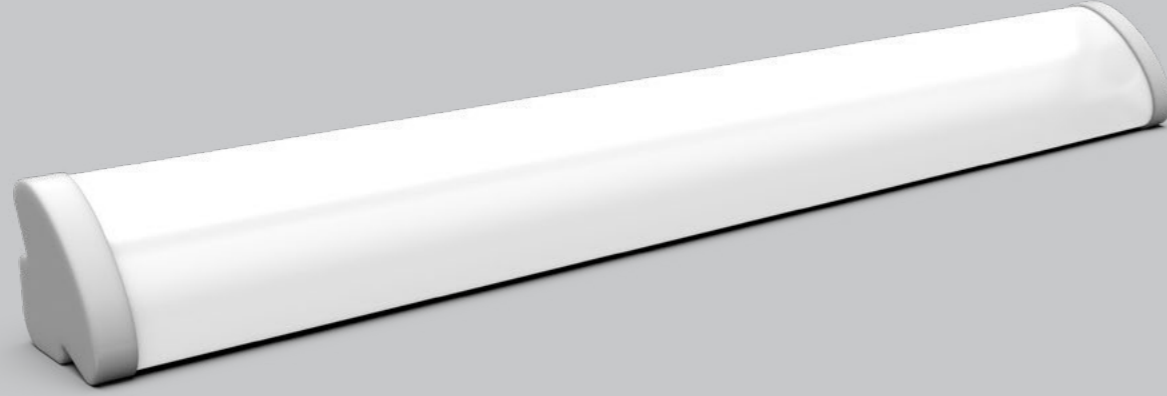

## KÖŞE ETANJ

Sürekli parlak, güvenilir ve titreşimsiz ışık çıkışı, yaşam alanlarınız için çevre dostu, enerji tasarruflu tüp ışıklardır. LED tavan çitaları floresan lambalar gibi toksik değildir, uzun ömürlü ve ekonomiktir.

## CORNER ETANJ

Consistently bright, reliable and flicker-free light output are environmentally friendly, energy-efficient tube lights for your living spaces. LED ceiling battens are non-toxic like fluorescent lamps, long-lasting and economical.

# KÖŞE ETANJ CORNER ETANJ

TURQUALITY®

Enerji Verimliliği Sınıfı Energy Efficiency Class	Ürün Kodu Product Code	Güç (W) Power	Renk Sıcaklığı (K) Color Temperature	Işık Akısı (Lm) Luminous Flux	Boyutlar (WxLxH) mm Dimensions	Renk Color	Koli Adeti Quantity in Carton	Fiyat Price
A+G F	BL-KE-0001	20W	6500 K	2000	79,4 × 600 × 56,8	Beyaz	12	\$18,80
A+G F	BL-KE-0002	20W	4000 K	2000	79,4 × 600 × 56,8	Beyaz	12	\$18,80
A+G F	BL-KE-0003	20W	3000 K	2000	79,4 × 600 × 56,8	Beyaz	12	\$18,80
A+G F	BL-KE-0004	40W	6500 K	2000	79,4 × 1200 × 56,8	Beyaz	12	\$32,40
A+G F	BL-KE-0005	40W	4000 K	4000	79,4 × 1200 × 56,8	Beyaz	12	\$32,40
A+G F	BL-KE-0006	40W	3000 K	4000	79,4 × 1200 × 56,8	Beyaz	12	\$32,40

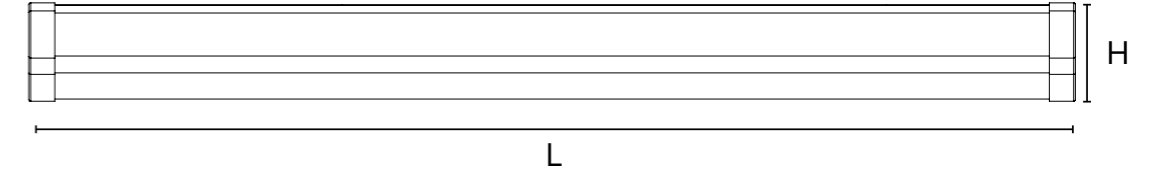
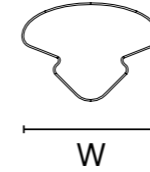



# ORTA ETANJ MID ETANJ

## Teknik Özellikler Technical Specifications

Gövde : Polikarbonat  
Body : Polycarbonate

Gövde Renkleri : Gri  
Body Colors : Grey

Kapak : Polikarbonat  
Cover : Polycarbonate

Kapak Rengi : Gri  
Cover Color : Grey

Renksel Geri Verim : 80  
Color Rendering Index : 80

IP Derecesi : IP65  
IP Rating : IP65

IK Derecesi : IK09  
IK Rating : IK09

Elektriksel Koruma : Sınıf II  
Electrical Protection : Class II

Çalışma Sıcaklığı : -20°C / 45°C  
Operating Temp. Range : -20°C / 45°C

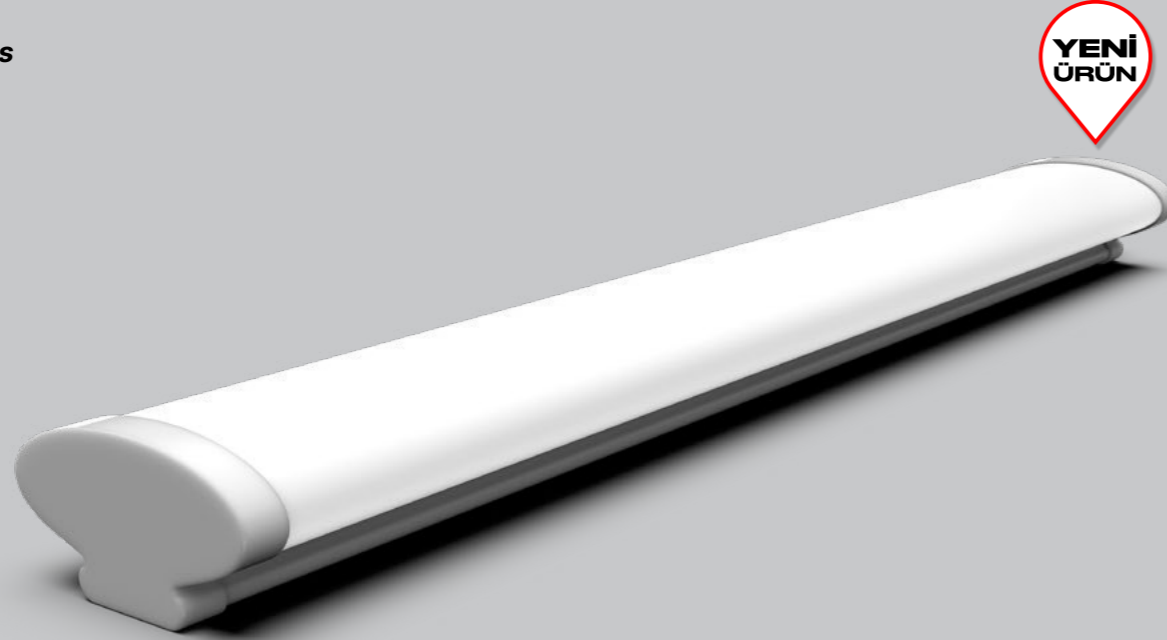

### ORTA ETANJ

Sürekli parlak, güvenilir ve titreşimsiz ışık çıkışı, yaşam alanlarınız için çevre dostu, enerji tasarruflu tüp ışıklardır. LED tavan çitaları floresan lambalar gibi toksik değildir, uzun ömürlü ve ekonomiktir.

### MID ETANJ

Consistently bright, reliable and flicker-free light output are environmentally friendly, energy-efficient tube lights for your living spaces. LED ceiling battens are non-toxic like fluorescent lamps, long-lasting and economical.

# ORTA ETANJ MID ETANJ

Enerji Verimliliği Sınıfı Energy Efficiency Class	Ürün Kodu Product Code	Güç (W) Power	Renk Sıcaklığı (K) Color Temperature	Işık Akısı (Lm) Luminous Flux	Boyutlar (WxLxH) mm Dimensions	Renk Color	Koli Adeti Quantity in Carton	Fiyat Price
A+G F	BL-ME-0001	20W	6500 K	2000	91,8 × 600 × 50,6	Beyaz	12	\$18,60
A+G F	BL-ME-0002	20W	4000 K	2000	91,8 × 600 × 50,6	Beyaz	12	\$18,60
A+G F	BL-ME-0003	20W	3000 K	2000	91,8 × 600 × 50,6	Beyaz	12	\$18,60
A+G F	BL-ME-0004	40W	6500 K	4000	91,8 × 1200 × 50,6	Beyaz	12	\$32,30
A+G F	BL-ME-0005	40W	4000 K	4000	91,8 × 1200 × 50,6	Beyaz	12	\$32,30
A+G F	BL-ME-0006	40W	3000 K	4000	91,8 × 1200 × 50,6	Beyaz	12	\$32,30

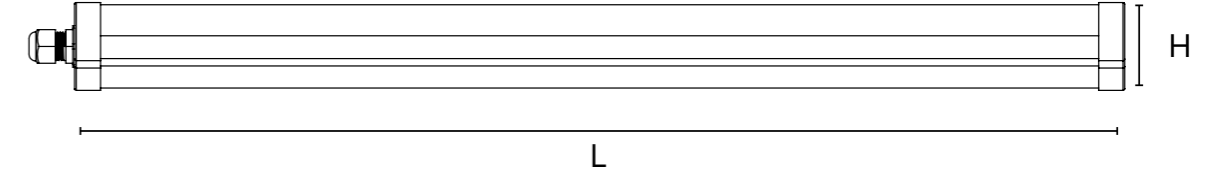
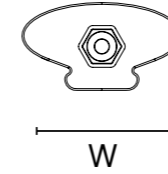

# LYRA ETANJ

## LYRA ETANJ

### Teknik Özellikler Technical Specifications

Gövde : Polikarbonat  
Body : Polycarbonate

Gövde Renkleri : Gri  
Body Colors : Grey

Kapak : Polikarbonat  
Cover : Polycarbonate

Kapak Rengi : Gri  
Cover Color : Grey

Renksel Geri Verim : 80  
Color Rendering Index : 80

IP Derecesi : IP65  
IP Rating : IP65

IK Derecesi : IK09  
IK Rating : IK09

Elektriksel Koruma : Sınıf II  
Electrical Protection : Class II

Çalışma Sıcaklığı : -20°C / 45°C  
Operating Temp. Range : -20°C / 45°C

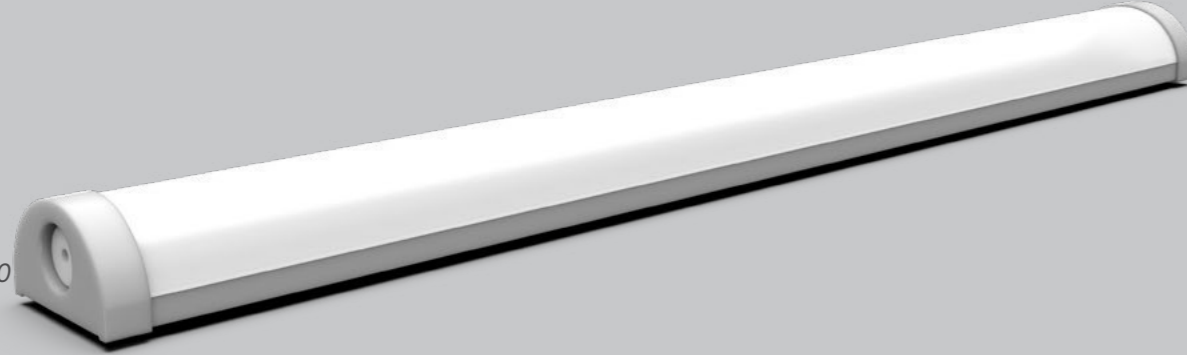

### LYRA ETANJ

Sürekli parlak, güvenilir ve titreşimsiz ışık çıkışı, yaşam alanlarınız için çevre dostu, enerji tasarruflu tüp ışıklardır. LED tavan çitaları floresan lambalar gibi toksik değildir, uzun ömürlü ve ekonomiktir.

### LYRA ETANJ

Consistently bright, reliable and flicker-free light output are environmentally friendly, energy-efficient tube lights for your living spaces. LED ceiling battens are non-toxic like fluorescent lamps, long-lasting and economical.

# LYRA ETANJ

## LYRA ETANJ

Enerji Verimliliği Sınıfı Energy Efficiency Class	Ürün Kodu Product Code	Güç (W) Power	Renk Sıcaklığı (K) Color Temperature	Işık Akısı (Lm) Luminous Flux	Boyutlar (WxLxH) mm Dimensions	Renk Color	Koli Adeti Quantity in Carton	Fiyat Price
A F	BL-EE-0001	20W	6500 K	2000	63 × 600 × 37	Beyaz	12	\$18,60
A F	BL-EE-0002	20W	4000 K	2000	63 × 600 × 37	Beyaz	12	\$18,60
A F	BL-EE-0003	20W	3000 K	2000	63 × 600 × 37	Beyaz	12	\$18,60
A F	BL-EE-0004	40W	3000 K	4000	63 × 1200 × 37	Beyaz	12	\$28,90
A F	BL-EE-0005	40W	4000 K	4000	63 × 1200 × 37	Beyaz	12	\$28,90
A F	BL-EE-0006	40W	6500 K	4000	63 × 1200 × 37	Beyaz	12	\$28,90

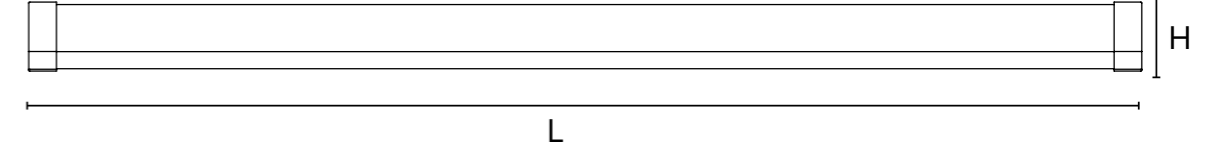
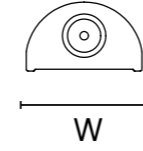

# PREMIUM ETANJ

## PREMIUM ETANJ

TURQUALITY®

### Teknik Özellikler Technical Specifications



Gövde : Polikarbonat  
Body : Polycarbonate

Gövde Renkleri : Gri  
Body Colors : Grey

Kapak : Polikarbonat  
Cover : Polycarbonate

Kapak Rengi : Gri  
Cover Color : Grey

Renksel Geri Verim : 80  
Color Rendering Index : 80

IP Derecesi : IP65  
IP Rating : IP65

IK Derecesi : IK09  
IK Rating : IK09

Elektriksel Koruma : Sınıf II  
Electrical Protection : Class II

Çalışma Sıcaklığı : -20°C / 45°C  
Operating Temp. Range : -20°C / 45°C

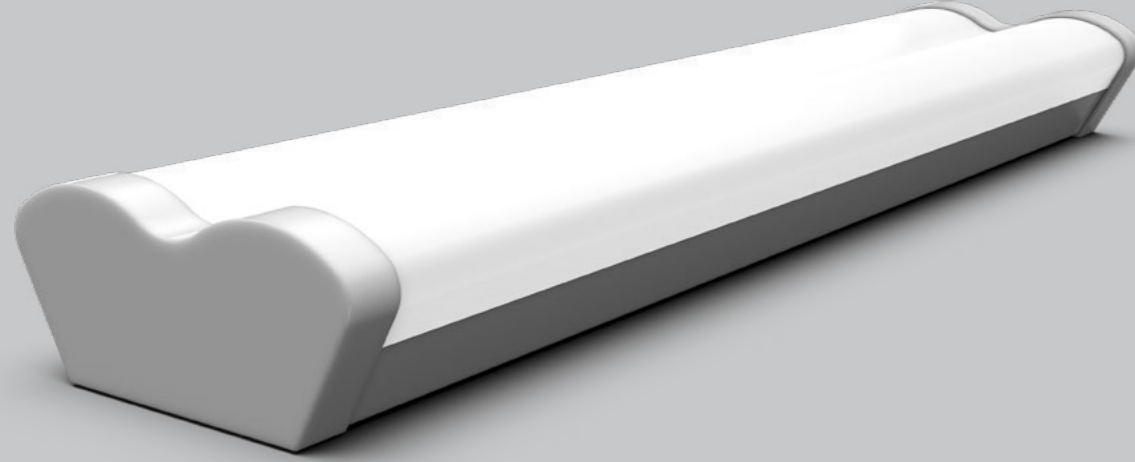

### PREMIUM ETANJ

Sürekli parlak, güvenilir ve titreşimsiz ışık çıkışı, yaşam alanlarınız için çevre dostu, enerji tasarruflu tüp ışıklardır. LED tavan çitaları floresan lambalar gibi toksik değildir, uzun ömürlü ve ekonomiktir.

### PREMIUM ETANJ

Consistently bright, reliable and flicker-free light output are environmentally friendly, energy-efficient tube lights for your living spaces. LED ceiling battens are non-toxic like fluorescent lamps, long-lasting and economical.

### PREMIUM ETANJ

#### PREMIUM ETANJ

Enerji Verimliliği Sınıfı Energy Efficiency Class	Ürün Kodu Product Code	Güç (W) Power	Renk Sıcaklığı (K) Color Temperature	Işık Akısı (Lm) Luminous Flux	Boyutlar (WxLxH) mm Dimensions	Renk Color	Koli Adeti Quantity in Carton	Fiyat Price
A+ F	BL-PE-0001	20W	6500 K	2400	146 × 600 × 67	Beyaz	6	\$37,00
A+ F	BL-PE-0002	20W	4000 K	2400	146 × 600 × 67	Beyaz	6	\$37,00
A+ F	BL-PE-0003	20W	3000 K	2400	146 × 600 × 67	Beyaz	6	\$37,00
A+ F	BL-PE-0004	40W	6500 K	4800	146 × 1200 × 67	Beyaz	6	\$51,40
A+ F	BL-PE-0005	40W	4000 K	4800	146 × 1200 × 67	Beyaz	6	\$51,40
A+ F	BL-PE-0006	40W	3000 K	4800	146 × 1200 × 67	Beyaz	6	\$51,40
A+ F	BL-PE-0007	80W	3000 K	9600	146 × 1200 × 67	Beyaz	6	\$66,70
A+ F	BL-PE-0008	80W	4000 K	9600	146 × 1200 × 67	Beyaz	6	\$66,70
A+ F	BL-PE-0009	80W	6500 K	9600	146 × 1200 × 67	Beyaz	6	\$66,70

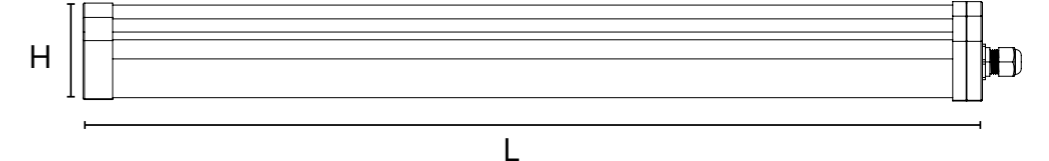
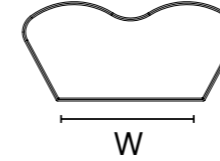

HASTANE  
HOSPITAL

borled®  
by borsan

117

Teknik veri / Datasheet

www.borled.com.tr

# EX-PROOF LED ETANJ

## EX-PROOF LED ETANJ

### Teknik Özellikler

#### Technical Specifications

Gövde : Polikarbonat (PC)  
Body : Polycarbonate

Gövde Renkleri : Turuncu  
Body Colors : Orange

Difüzör : Polikarbonat (PC)  
Diffuser : Polycarbonate

Renksel Geri Verim : 80  
Color Rendering Index : 80

IP Derecesi : IP65  
IP Rating : IP65

IK Derecesi : IK08  
IK Rating : IK08

Elektriksel Koruma : Sınıf I  
Electrical Protection : Class I

Çalışma Sıcaklığı : -20°C / 45°C  
Operating Temp. Range : -20°C / 45°C

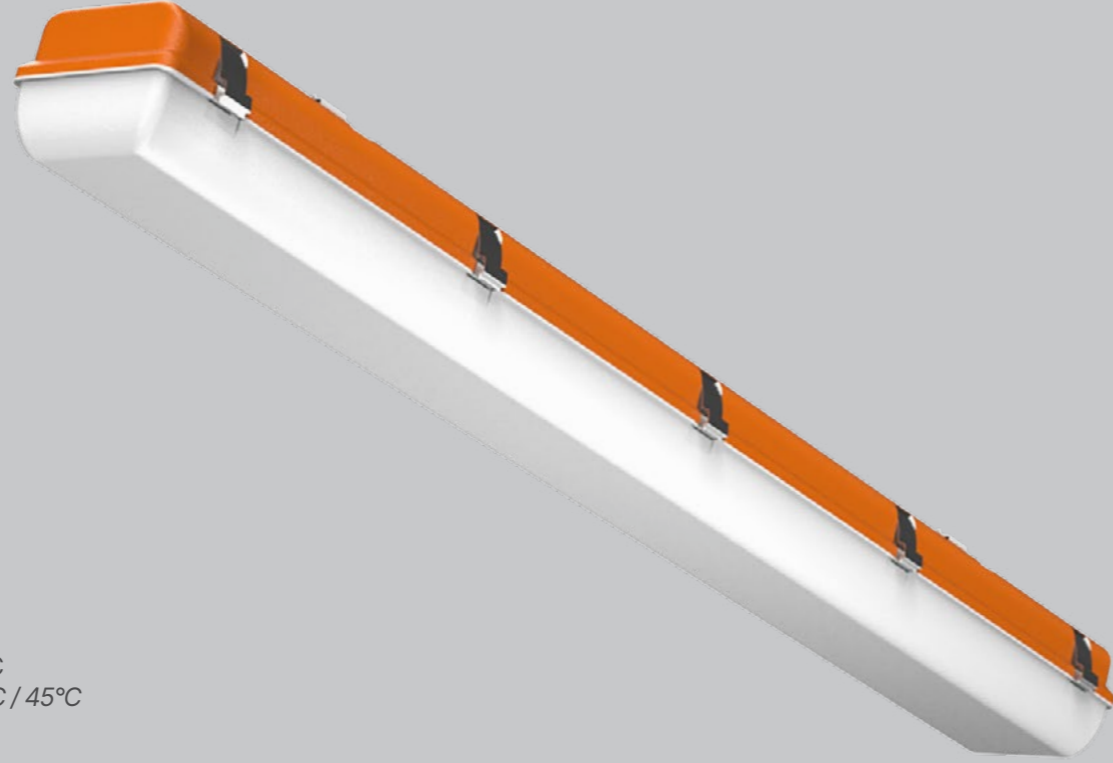

### EX-PROOF LED ETANJ

Yüksek darbe dayanımlı polikarbonat gövde ve ideal tasarım elektrostatik toz boya ile sararma ve korozyona karşı dayanıklıdır. Polikarbon difüzör, optik homojen ışık yayılımı ve yüksek ışık geçirgenliği sağlar. Bu ürün kullanım yeri ve talep edilen normlara uygun ex-proof özelliklere sahiptir.

\*Ex-proof Led Etanj Armatür, grup II tehlikeli açık ya da kapalı alanlarda kullanılmaktadır.

\*Ex-proof kelimesi "Explosion-proof"un kısaltılmış halidir. Türkçede "patlamaya dayanıklı" olarak bilinmektedir.

Petrol ürün tesisleri, gaz istasyonları, rafineriler, kömür madenleri ve demir-çelik sanayi ayrıca şeker ve un fabrikaları gibi. Tehlikeli ve patlayıcı maddeler içeren çalışma ortamlarında patlamaları önlemek için güvenlik amaçlı kullanılan özel ürünlerdir.

### EX-PROOF LED ETANJ

High impact polycarbonate body and ideal design electrostatic powder paint are resistant to yellowing and corrosion. The polycarbonate diffuser provides optical homogeneous light distribution and high light transmission. This product has ex-proof features by the place of use and the requested norms.

\*Ex-proof Led lighting fixtures are used in Group II hazardous areas at indoor or outdoor services.

\*The word exproof is the abbreviation of "Explosion-proof". It is known as "explosion-proof" in Turkish.

These are specific products used for safety purposes to prevent explosions in working environments containing hazardous and explosive substances. Such as oil product plants, gas stations, refineries, coal mines and iron and steel industries as well as sugar and flour mills.

### EX-PROOF LED ETANJ

#### EX-PROOF LED ETANJ

Enerji Verimliliği Sınıfı Energy Efficiency Class	Ürün Kodu Product Code	Güç (W) Power	Renk Sıcaklığı (K) Color Temperature	Işık Akısı (Lm) Luminous Flux	Boyutlar (WxLxH) mm Dimensions	Renk Color	Koli Adeti Quantity in Carton	Fiyat Price
A F G	BL-EX-0001	20W	3000 K	2200	95 × 670 × 125	Turuncu	1	\$158,10
A F G	BL-EX-0002	20W	4000 K	2200	95 × 670 × 125	Turuncu	1	\$158,10
A F G	BL-EX-0003	20W	6500 K	2200	95 × 670 × 125	Turuncu	1	\$158,10
A F G	BL-EX-0004	40W	3000 K	4400	95 × 1270 × 125	Turuncu	1	\$168,30
A F G	BL-EX-0005	40W	4000 K	4400	95 × 1270 × 125	Turuncu	1	\$168,30
A F G	BL-EX-0006	40W	6500 K	4400	95 × 1270 × 125	Turuncu	1	\$168,30
A F G	BL-EX-0007	60W	3000 K	6600	95 × 1270 × 125	Turuncu	1	\$183,60
A F G	BL-EX-0008	60W	4000 K	6600	95 × 1270 × 125	Turuncu	1	\$183,60
A F G	BL-EX-0009	60W	6500 K	6600	95 × 1270 × 125	Turuncu	1	\$183,60

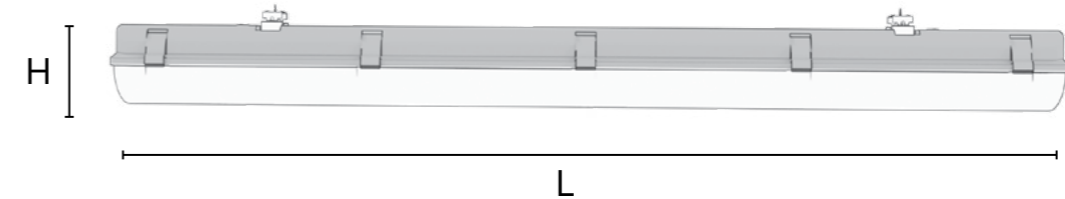
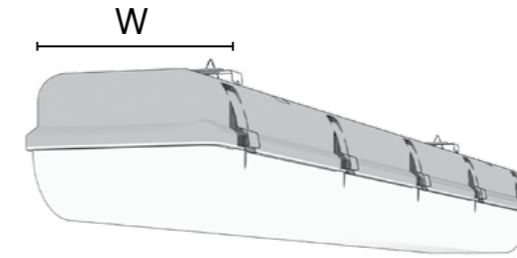

Teknik veri / Datasheet

www.borled.com.tr

# T5 LED TUBE ARMATÜR

## T5 LED TUBE ARMATURE

### Teknik Özellikler

#### Technical Specifications

Gövde : Polikarbonat-TUBE  
Body : Polycarbonate

Gövde Renkleri : Beyaz  
Body Colors : White

Difüzör : Polikarbonat (PC)  
Diffuser : Polycarbonate

Renksel Geri Verim : 80  
Color Rendering Index : 80

IP Derecesi : IP20  
IP Rating : IP20

IK Derecesi : IK02  
IK Rating : IK02

Elektriksel Koruma : Sınıf I  
Electrical Protection : Class I

Çalışma Sıcaklığı : -20°C / 45°C  
Operating Temp. Range : -20°C / 45°C

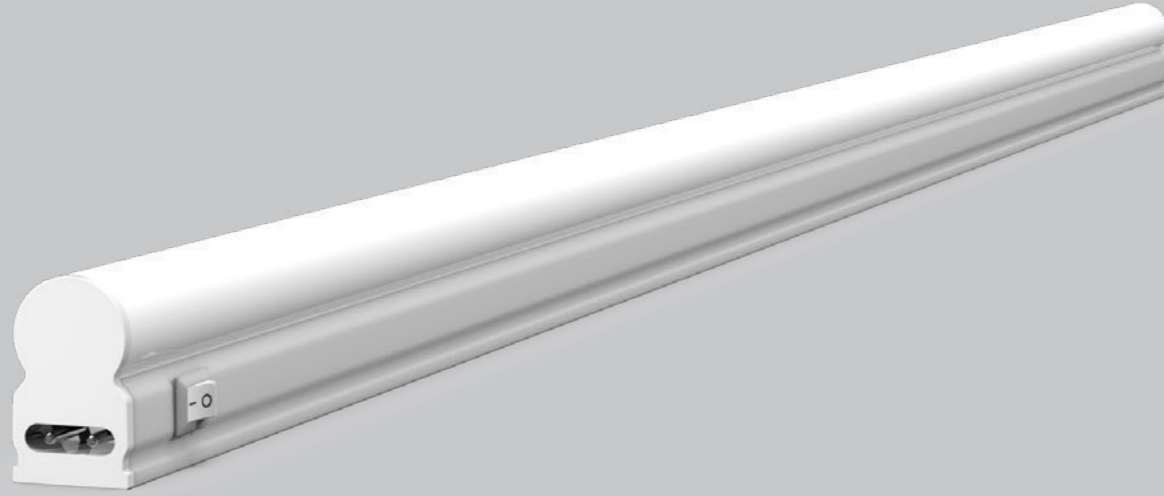

### T5 LED TUBE ARMATÜR

Sıcak ışık-nötr ışık-beyaz ışık seçenekleri sunan entegre sürücü ve led çiplerin verimli kullanımı ile sorunsuz ısı dağılımına ve uzun hizmet ömrüne sahiptir.

Ev, ofis, showrooamlar, alışveriş merkezleri, hastaneler ve oteller gibi iç mekan uygulamaları için tasarlanmış, mükemmel bir aydınlatma çözümüdür.

### T5 LED TUBE ARMATÜRE

It has problem-free heat dissipation and long service life with the efficient use of an integrated driver and led chips that offer warm light-neutral light-white light options. It is an excellent lighting solution designed for indoor applications such as homes, offices, showrooms, shopping malls, hospitals and hotels.

# T5 LED TUBE ARMATÜR

## T5 LED TUBE ARMATURE

Enerji Verimliliği Sınıfı Energy Efficiency Class	Ürün Kodu Product Code	Güç (W) Power	Renk Sıcaklığı (K) Color Temperature	Işık Akısı (Lm) Luminous Flux	Boyutlar (WxLxH) mm Dimensions	Renk Color	Koli Adeti Quantity in Carton	Fiyat Price
A+ F	BL-TB-0001	4W	6500 K	380	25 x 300 x 35	Beyaz	20	\$8,1
A+ F	BL-TB-0002	4W	4000 K	380	25 x 300 x 35	Beyaz	20	\$8,1
A+ F	BL-TB-0003	4W	3000 K	380	25 x 300 x 35	Beyaz	20	\$8,1
A+ F	BL-TB-0004	8W	6500 K	760	25 x 600 x 35	Beyaz	20	\$10,0
A+ F	BL-TB-0005	8W	4000 K	760	25 x 600 x 35	Beyaz	20	\$10,0
A+ F	BL-TB-0006	8W	3000 K	760	25 x 600 x 35	Beyaz	20	\$10,0
A+ F	BL-TB-0007	12W	6500 K	1150	25 x 900 x 35	Beyaz	20	\$12,0
A+ F	BL-TB-0008	12W	4000 K	1150	25 x 900 x 35	Beyaz	20	\$12,0
A+ F	BL-TB-0009	12W	3000 K	1150	25 x 900 x 35	Beyaz	20	\$12,0
A+ F	BL-TB-0010	16W	6500 K	1500	25 x 1200 x 35	Beyaz	20	\$13,4
A+ F	BL-TB-0011	16W	4000 K	1500	25 x 1200 x 35	Beyaz	20	\$13,4
A+ F	BL-TB-0012	16W	3000 K	1500	25 x 1200 x 35	Beyaz	20	\$13,4

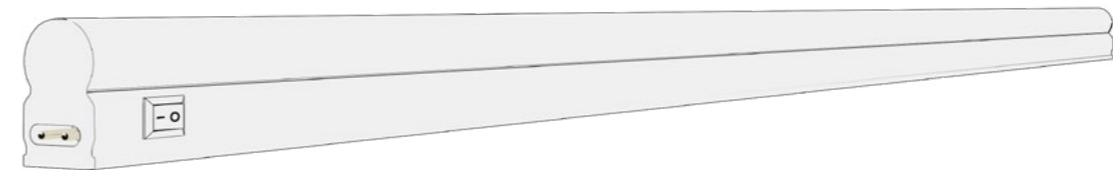
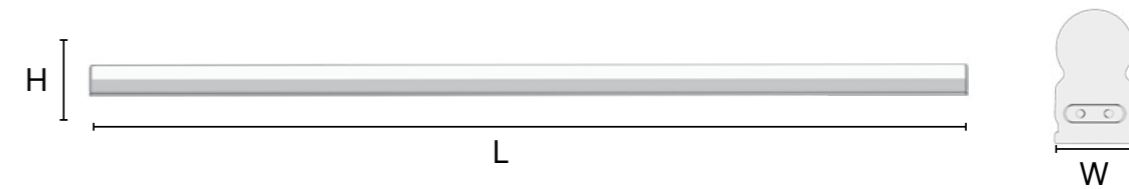

Teknik veri / Datasheet

www.borled.com.tr

# AYNA ÜSTÜ ARMATÜR ABOVE MIRROR ARMATURE

## Teknik Özellikler Technical Specifications

Gövde : Krom  
Body : Chrome

Çalışma Gerilimi : 220-240 V AC  
Operating Voltage : 220-240 V AC

Gövde Renkleri : Metalik  
Body Colors : Metallic

Renksel Geri Verim : 80  
Color Rendering Index : 80

IP Derecesi : IP20  
IP Rating : IP20

Çalışma Sıcaklığı : -20 C / 45 C  
Operating Temp. Range : -20 C / 45 C



24 W



12 W



### AYNA ÜSTÜ ARMATÜR

Akrilik difüzör ve homojen led aydınlatma sağlayan mafsallı başlığıyla işlevsel. Paslanmaz krom kaplamalı gövdesi ile ışık ve hijyenik bir aydınlatma armatürüdür.

### ABOVE MIRROR ARMATURE

Functional with an acrylic diffuser and an articulated head that provides homogeneous LED lighting. It is a stylish and hygienic lighting fixture with its stainless chrome plated body.

# AYNA ÜSTÜ ARMATÜR ABOVE MIRROR ARMATURE

Enerji Verimliliği Sınıfı Energy Efficiency Class	Ürün Kodu Product Code	Güç (W) Power	Renk Sıcaklığı (K) Color Temperature	Işık Akısı (Lm) Luminous Flux	Boyutlar (WxLxH) mm Dimensions	Renk Color	Koli Adeti Quantity in Carton	Fiyat Price
A T G	BL-AU-0001	12W	3000 K	840	115 × 570 × 170	Metalik	15	\$69,50
A T G	BL-AU-0002	12W	4000 K	840	115 × 570 × 170	Metalik	15	\$69,50
A T G	BL-AU-0003	12W	6500 K	840	115 × 570 × 170	Metalik	15	\$69,50
A T G	BL-AU-1001	24W	3000 K	1680	90 × 570 × 220	Metalik	12	\$80,20
A T G	BL-AU-1002	24W	4000 K	1680	90 × 570 × 220	Metalik	12	\$80,20
A T G	BL-AU-1003	24W	6500 K	1680	90 × 570 × 220	Metalik	12	\$80,20

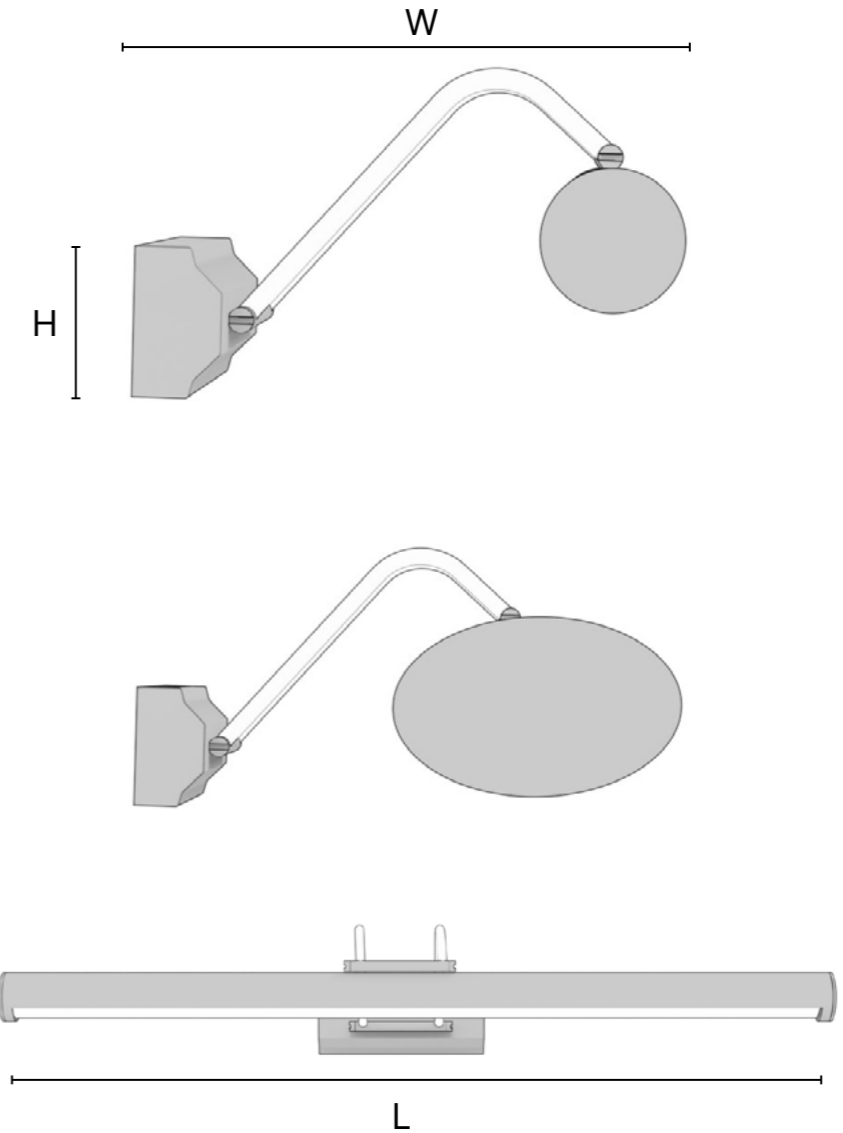

# OVAL LED GLOP ARMATÜR

## OVAL LED GLOBE ARMATURE

### Teknik Özellikler

#### Technical Specifications

Gövde : DKP Sac  
Body : DKP Metal Sheet

Gövde Renkleri : Beyaz  
Body Colors : White

Difüzör : Akrilik  
Diffuser : Acrylic

Renksel Geri Verim : 80  
Color Rendering Index : 80

IP Derecesi : IP20  
IP Rating : IP20

IK Derecesi : IK03  
IK Rating : IK03

Elektriksel Koruma : Sınıf I  
Electrical Protection : Class I

Çalışma Sıcaklığı : -20°C / 45°C  
Operating Temp. Range : -20°C / 45°C

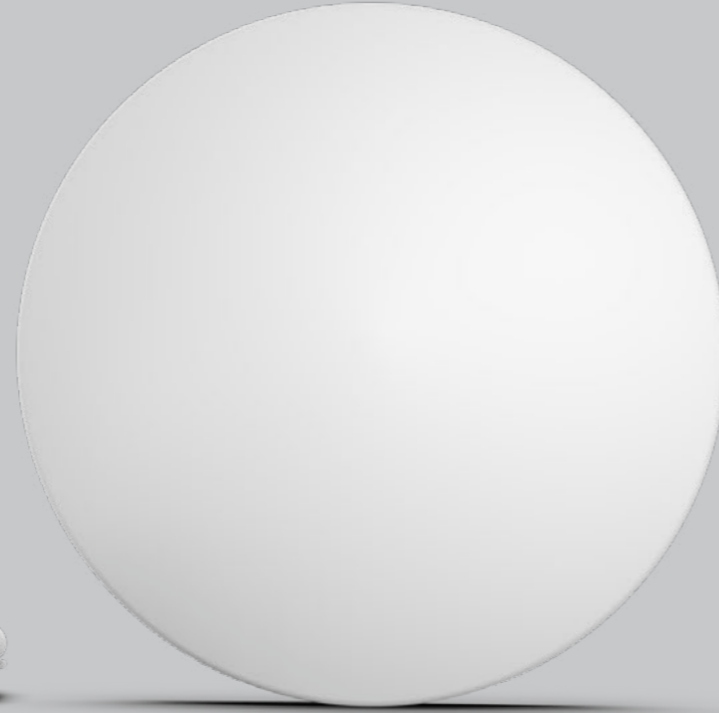

### OVAL LED GLOP ARMATÜR

Bu armatürler fonksiyonel üst kapaklarından dolayı Glop adını almıştır. Glop ürünler yüzeysel bir aydınlatma yerine daha geniş, detaylı ve homojen aydınlatma sağlamaktadır.

### OVAL LED GLOBE ARMATURE

These luminaires are named Glop because of their functional top covers. Glop products provide expanse, detailed and homogeneous lighting instead of superficial lighting.

# OVAL LED GLOP ARMATÜR

## OVAL LED GLOBE ARMATURE

Enerji Verimliliği Sınıfı Energy Efficiency Class	Ürün Kodu Product Code	Güç (W) Power	Renk Sıcaklığı (K) Color Temperature	Işık Akısı (Lm) Luminous Flux	Boyutlar (ØxH) mm Dimensions	Opsiyonlar Options	Koli Adeti Quantity in Carton	Fiyat Price	
A+G	F	BL-G1-0002	12W	3000 K	1080	260 × 83	-	24	\$25,90
A+G	F	BL-G1-0014	12W	4000 K	1080	260 × 83	-	24	\$25,90
A+G	F	BL-G1-0008	12W	6500 K	1080	260 × 83	-	24	\$25,90
A+G	F	BL-G1-0002-RS	12W	3000 K	1080	260 × 83	Radar Sensörlü	24	\$35,20
A+G	F	BL-G1-0014-RS	12W	4000 K	1080	260 × 83	Radar Sensörlü	24	\$35,20
A+G	F	BL-G1-0008-RS	12W	6500 K	1080	260 × 83	Radar Sensörlü	24	\$35,20
A+G	F	BL-G1-0002-1H	12W	3000 K	1080	260 × 83	1 Saat Acil Kit	24	\$47,50
A+G	F	BL-G1-0014-1H	12W	4000 K	1080	260 × 83	1 Saat Acil Kit	24	\$47,50
A+G	F	BL-G1-0008-1H	12W	6500 K	1080	260 × 83	1 Saat Acil Kit	24	\$47,50
A+G	F	BL-G1-0002-RS-1H	12W	3000 K	1080	260 × 83	Radar Sensör & 1 Saat Acil Kit	24	\$52,00
A+G	F	BL-G1-0014-RS-1H	12W	4000 K	1080	260 × 83	Radar Sensör & 1 Saat Acil Kit	24	\$52,00
A+G	F	BL-G1-0008-RS-1H	12W	6500 K	1080	260 × 83	Radar Sensör & 1 Saat Acil Kit	24	\$52,00
A+G	F	BL-G1-0002-3H	12W	3000 K	1080	260 × 83	3 Saat Acil Kit	24	\$55,80
A+G	F	BL-G1-0014-3H	12W	4000 K	1080	260 × 83	3 Saat Acil Kit	24	\$55,80
A+G	F	BL-G1-0008-3H	12W	6500 K	1080	260 × 83	3 Saat Acil Kit	24	\$55,80
A+G	F	BL-G1-0002-RS-3H	12W	3000 K	1080	260 × 83	Radar Sensör & 3 Saat Acil Kit	24	\$62,30
A+G	F	BL-G1-0014-RS-3H	12W	4000 K	1080	260 × 83	Radar Sensör & 3 Saat Acil Kit	24	\$62,30
A+G	F	BL-G1-0008-RS-3H	12W	6500 K	1080	260 × 83	Radar Sensör & 3 Saat Acil Kit	24	\$62,30
A+G	F	BL-G1-0004	18W	3000 K	1620	330 × 96	-	12	\$32,50
A+G	F	BL-G1-0016	18W	4000 K	1620	330 × 96	-	12	\$32,50
A+G	F	BL-G1-0010	18W	6500 K	1620	330 × 96	-	12	\$32,50
A+G	F	BL-G1-0004-RS	18W	3000 K	1620	330 × 96	Radar Sensörlü	12	\$41,80
A+G	F	BL-G1-0016-RS	18W	4000 K	1620	330 × 96	Radar Sensörlü	12	\$41,80
A+G	F	BL-G1-0010-RS	18W	6500 K	1620	330 × 96	Radar Sensörlü	12	\$41,80
A+G	F	BL-G1-0004-1H	18W	3000 K	1620	330 × 96	1 Saat Acil Kit	12	\$54,00
A+G	F	BL-G1-0010-1H	18W	6500 K	1620	330 × 96	1 Saat Acil Kit	12	\$54,00
A+G	F	BL-G1-0016-1H	18W	4000 K	1620	330 × 96	1 Saat Acil Kit	12	\$54,00

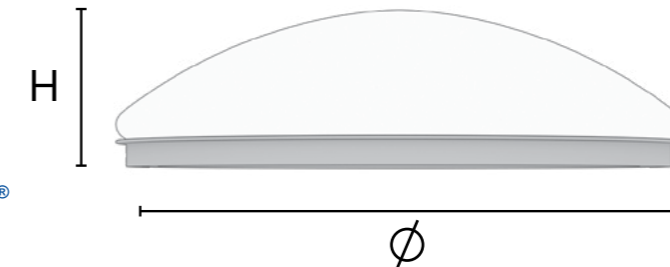

Teknik veri / Datasheet

www.borled.com.tr

# OVAL LED GLOP ARMATÜR

## OVAL LED GLOBE ARMATURE

### Teknik Özellikler

#### Technical Specifications

Gövde : DKP Sac  
Body : DKP Metal Sheet

Gövde Renkleri : Beyaz  
Body Colors : White

Difüzör : Akrilik  
Diffuser : Acrylic

Renksel Geri Verim : 80  
Color Rendering Index : 80

IP Derecesi : IP20  
IP Rating : IP20

IK Derecesi : IK03  
IK Rating : IK03

Elektriksel Koruma : Sınıf I  
Electrical Protection : Class I

Çalışma Sıcaklığı : -20°C / 45°C  
Operating Temp. Range : -20°C / 45°C

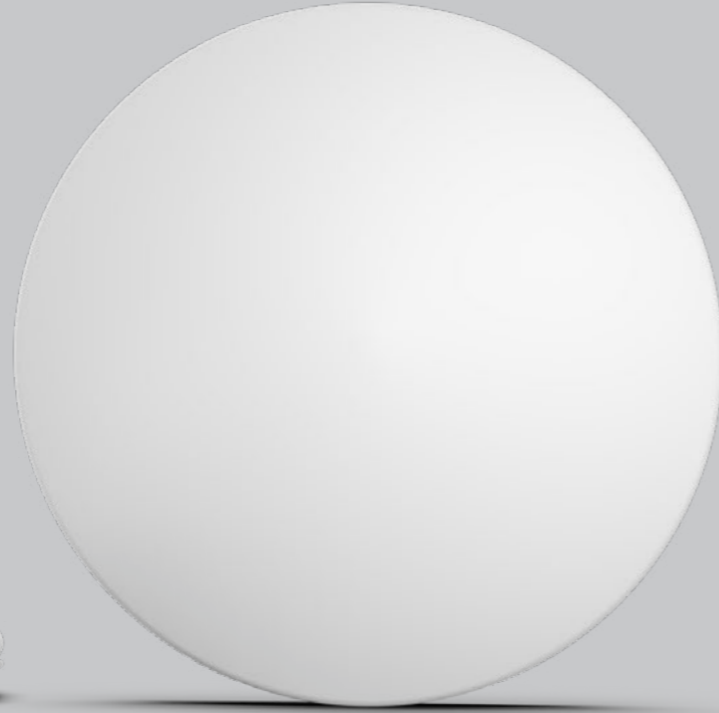

### OVAL LED GLOP ARMATÜR

Bu armatürler fonksiyonel üst kapaklarından dolayı Glop adını almıştır. Glop ürünler yüzeysel bir aydınlatma yerine daha geniş, detaylı ve homojen aydınlatma sağlamaktadır.

### OVAL LED GLOBE ARMATURE

These luminaires are named Glop because of their functional top covers. Glop products provide expanse, detailed and homogeneous lighting instead of superficial lighting.

# OVAL LED GLOP ARMATÜR

## OVAL LED GLOBE ARMATURE

Enerji Verimliliği Sınıfı Energy Efficiency Class	Ürün Kodu Product Code	Güç (W) Power	Renk Sıcaklığı (K) Color Temperature	Işık Akısı (Lm) Luminous Flux	Boyutlar (ØxH) mm Dimensions	Opsiyonlar Options	Koli Adeti Quantity in Carton	Fiyat Price
A+ F	BL-G1-0010-RS-1H	18W	6500 K	1620	330 x 96	Radar Sensör & 1 Saat Acil Kit	12	\$58,50
A+ F	BL-G1-0004-RS-1H	18W	3000 K	1620	330 x 96	Radar Sensör & 1 Saat Acil Kit	12	\$58,50
A+ F	BL-G1-0016-RS-1H	18W	4000 K	1620	330 x 96	Radar Sensör & 1 Saat Acil Kit	12	\$58,50
A+ F	BL-G1-0004-3H	18W	3000 K	1620	330 x 96	3 Saat Acil Kit	12	\$62,30
A+ F	BL-G1-0016-3H	18W	4000 K	1620	330 x 96	3 Saat Acil Kit	12	\$62,30
A+ F	BL-G1-0010-3H	18W	6500 K	1620	330 x 96	3 Saat Acil Kit	12	\$62,30
A+ F	BL-G1-0004-RS-3H	18W	3000 K	1620	330 x 96	Radar Sensör & 3 Saat Acil Kit	12	\$68,90
A+ F	BL-G1-0016-RS-3H	18W	4000 K	1620	330 x 96	Radar Sensör & 3 Saat Acil Kit	12	\$68,90
A+ F	BL-G1-0010-RS-3H	18W	6500 K	1620	330 x 96	Radar Sensör & 3 Saat Acil Kit	12	\$68,90
A+ F	BL-G1-0006	24W	3000 K	2160	380 x 100	-	6	\$39,80
A+ F	BL-G1-0018	24W	4000 K	2160	380 x 100	-	6	\$39,80
A+ F	BL-G1-0012	24W	6500 K	2160	380 x 100	-	6	\$39,80
A+ F	BL-G1-0006-RS	24W	3000 K	2160	380 x 100	Radar Sensörlü	6	\$49,00
A+ F	BL-G1-0018-RS	24W	4000 K	2160	380 x 100	Radar Sensörlü	6	\$49,00
A+ F	BL-G1-0012-RS	24W	6500 K	2160	380 x 100	Radar Sensörlü	6	\$49,00
A+ F	BL-G1-0006-1H	24W	3000 K	2160	380 x 100	1 Saat Acil Kit	6	\$61,30
A+ F	BL-G1-0018-1H	24W	4000 K	2160	380 x 100	1 Saat Acil Kit	6	\$61,30
A+ F	BL-G1-0012-1H	24W	6500 K	2160	380 x 100	1 Saat Acil Kit	6	\$61,30
A+ F	BL-G1-0006-RS-1H	24W	3000 K	2160	380 x 100	Radar Sensör & 1 Saat Acil Kit	6	\$65,80
A+ F	BL-G1-0012-RS-1H	24W	6500 K	2160	380 x 100	Radar Sensör & 1 Saat Acil Kit	6	\$65,80
A+ F	BL-G1-0018-RS-1H	24W	4000 K	2160	380 x 100	Radar Sensör & 1 Saat Acil Kit	6	\$65,80
A+ F	BL-G1-0006-3H	24W	3000 K	2160	380 x 100	3 Saat Acil Kit	6	\$69,60
A+ F	BL-G1-0018-3H	24W	4000 K	2160	380 x 100	3 Saat Acil Kit	6	\$69,60
A+ F	BL-G1-0012-3H	24W	6500 K	2160	380 x 100	3 Saat Acil Kit	6	\$69,60
A+ F	BL-G1-0006-RS-3H	24W	3000 K	2160	380 x 100	Radar Sensör & 3 Saat Acil Kit	6	\$76,20
A+ F	BL-G1-0012-RS-3H	24W	6500 K	2160	380 x 100	Radar Sensör & 3 Saat Acil Kit	6	\$76,20
A+ F	BL-G1-0018-RS-3H	24W	4000 K	2160	380 x 100	Radar Sensör & 3 Saat Acil Kit	6	\$76,20

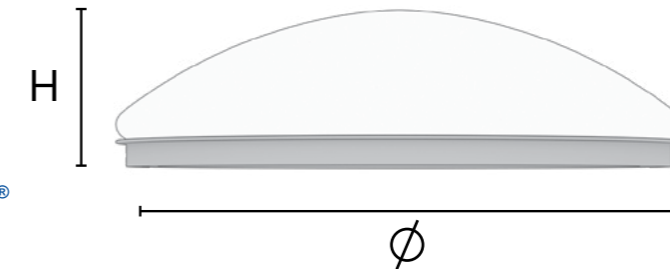



# FLAT LED GLOP ARMATÜR

## FLAT LED GLOBE ARMATURE

### Teknik Özellikler

#### Technical Specifications

Gövde : DKP Sac  
Body : DKP Metal Sheet

Gövde Renkleri : Beyaz  
Body Colors : White

Difüzör : Akrilik  
Diffuser : Acrylic

Renksel Geri Verim : 80  
Color Rendering Index : 80

IP Derecesi : IP20  
IP Rating : IP20

IK Derecesi : IK03  
IK Rating : IK03

Elektriksel Koruma : Sınıf I  
Electrical Protection : Class I

Çalışma Sıcaklığı : -20°C / 45°C  
Operating Temp. Range : -20°C / 45°C



### FLAT LED GLOP ARMATÜR

Bu armatürler fonksiyonel üst kapaklarından dolayı Glop adını almıştır. Glop ürünler yüzeysel bir aydınlatma yerine daha geniş, detaylı ve homojen aydınlatma sağlamaktadır.

### FLAT LED GLOBE ARMATURE

These luminaires are named Glop because of their functional top covers. Glop products provide expanse, detailed and homogeneous lighting instead of superficial lighting.

# FLAT LED GLOP ARMATÜR

## FLAT LED GLOBE ARMATURE

Enerji Verimliliği Sınıfı Energy Efficiency Class	Ürün Kodu Product Code	Güç (W) Power	Renk Sıcaklığı (K) Color Temperature	Işık Akısı (Lm) Luminous Flux	Boyutlar (ØxH) mm Dimensions	Opsiyonlar Options	Koli Adeti Quantity in Carton	Fiyat Price	
A+G	F	BL-G1-0001	12W	3000 K	1080	260 × 83	-	24	\$25,90
A+G	F	BL-G1-0013	12W	4000 K	1080	260 × 83	-	24	\$25,90
A+G	F	BL-G1-0007	12W	6500 K	1080	260 × 83	-	24	\$25,90
A+G	F	BL-G1-0001-RS	12W	3000 K	1080	260 × 83	Radar Sensörlü	24	\$35,20
A+G	F	BL-G1-0013-RS	12W	4000 K	1080	260 × 83	Radar Sensörlü	24	\$35,20
A+G	F	BL-G1-0007-RS	12W	6500 K	1080	260 × 83	Radar Sensörlü	24	\$35,20
A+G	F	BL-G1-0001-RS-1H	12W	3000 K	1080	260 × 83	Radar Sensörlü 1 Saat Acil Kit	24	\$52,00
A+G	F	BL-G1-0013-RS-1H	12W	4000 K	1080	260 × 83	Radar Sensörlü 1 Saat Acil Kit	24	\$52,00
A+G	F	BL-G1-0007-RS-1H	12W	6500 K	1080	260 × 83	Radar Sensörlü 1 Saat Acil Kit	24	\$52,00
A+G	F	BL-G1-0001-1H	12W	3000 K	1080	260 × 83	1 Saat Acil Kit	24	\$47,50
A+G	F	BL-G1-0007-1H	12W	6500 K	1080	260 × 83	1 Saat Acil Kit	24	\$47,50
A+G	F	BL-G1-0013-1H	12W	4000 K	1080	260 × 83	1 Saat Acil Kit	24	\$47,50
A+G	F	BL-G1-0001-3H	12W	3000 K	1080	260 × 83	3 Saat Acil Kit	24	\$55,80
A+G	F	BL-G1-0013-3H	12W	4000 K	1080	260 × 83	3 Saat Acil Kit	24	\$55,80
A+G	F	BL-G1-0007-3H	12W	6500 K	1080	260 × 83	3 Saat Acil Kit	24	\$55,80
A+G	F	BL-G1-0001-RS-3H	12W	3000 K	1080	260 × 83	Radar Sensörlü 3 Saat Acil Kit	24	\$62,40
A+G	F	BL-G1-0013-RS-3H	12W	4000 K	1080	260 × 83	Radar Sensörlü 3 Saat Acil Kit	24	\$62,40
A+G	F	BL-G1-0007-RS-3H	12W	6500 K	1080	260 × 83	Radar Sensörlü 3 Saat Acil Kit	24	\$62,40
A+G	F	BL-G1-0003	18W	3000 K	1620	330 × 96	-	12	\$32,50
A+G	F	BL-G1-0015	18W	4000 K	1620	330 × 96	-	12	\$32,50
A+G	F	BL-G1-0009	18W	6500 K	1620	330 × 96	-	12	\$32,50
A+G	F	BL-G1-0003-RS	18W	3000 K	1620	330 × 96	Radar Sensörlü	12	\$41,80
A+G	F	BL-G1-0015-RS	18W	4000 K	1620	330 × 96	Radar Sensörlü	12	\$41,80
A+G	F	BL-G1-0009-RS	18W	6500 K	1620	330 × 96	Radar Sensörlü	12	\$41,80
A+G	F	BL-G1-0003-1H	18W	3000 K	1620	330 × 96	1 Saat Acil Kit	12	\$54,10
A+G	F	BL-G1-0015-1H	18W	4000 K	1620	330 × 96	1 Saat Acil Kit	12	\$54,10
A+G	F	BL-G1-0009-1H	18W	6500 K	1620	330 × 96	1 Saat Acil Kit	12	\$54,10

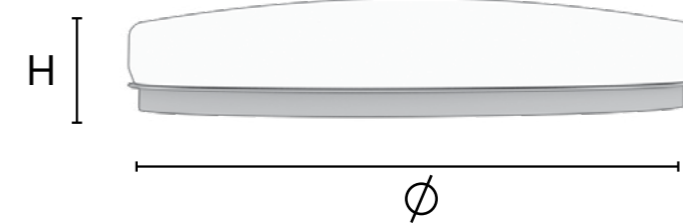

Teknik veri / Datasheet

www.borled.com.tr

# FLAT LED GLOP ARMATÜR

## FLAT LED GLOBE ARMATURE

### Teknik Özellikler

#### Technical Specifications

Gövde : DKP Sac  
Body : DKP Metal Sheet

Gövde Renkleri : Beyaz  
Body Colors : White

Difüzör : Akrilik  
Diffuser : Acrylic

Renksel Geri Verim : 80  
Color Rendering Index : 80

IP Derecesi : IP20  
IP Rating : IP20

IK Derecesi : IK03  
IK Rating : IK03

Elektriksel Koruma : Sınıf I  
Electrical Protection : Class I

Çalışma Sıcaklığı : -20°C / 45°C  
Operating Temp. Range : -20°C / 45°C



### FLAT LED GLOP ARMATÜR

Bu armatürler fonksiyonel üst kapaklarından dolayı Glop adını almıştır. Glop ürünler yüzeysel bir aydınlatma yerine daha geniş, detaylı ve homojen aydınlatma sağlamaktadır.

### FLAT LED GLOBE ARMATURE

These luminaires are named Glop because of their functional top covers. Glop products provide expanse, detailed and homogeneous lighting instead of superficial lighting.

# FLAT LED GLOP ARMATÜR

## FLAT LED GLOBE ARMATURE

Enerji Verimliliği Sınıfı Energy Efficiency Class	Ürün Kodu Product Code	Güç (W) Power	Renk Sıcaklığı (K) Color Temperature	Işık Akısı (Lm) Luminous Flux	Boyutlar (ØxH) mm Dimensions	Opsiyonlar Options	Koli Adeti Quantity in Carton	Fiyat Price
A F G	BL-G1-0003-RS-1H	18W	3000 K	1620	330 × 96	Radar Sensörlü 1 Saat Acil Kit	12	\$58,50
A F G	BL-G1-0015-RS-1H	18W	4000 K	1620	330 × 96	Radar Sensörlü 1 Saat Acil Kit	12	\$58,50
A F G	BL-G1-0009-RS-1H	18W	6500 K	1620	330 × 96	Radar Sensörlü 1 Saat Acil Kit	12	\$58,50
A F G	BL-G1-0003-3H	18W	3000 K	1620	330 × 96	3 Saat Acil Kit	12	\$62,40
A F G	BL-G1-0015-3H	18W	4000 K	1620	330 × 96	3 Saat Acil Kit	12	\$62,40
A F G	BL-G1-0009-3H	18W	6500 K	1620	330 × 96	3 Saat Acil Kit	12	\$62,40
A F G	BL-G1-0003-RS-3H	18W	3000 K	1620	330 × 96	Radar Sensörlü 3 Saat Acil Kit	12	\$68,90
A F G	BL-G1-0015-RS-3H	18W	4000 K	1620	330 × 96	Radar Sensörlü 3 Saat Acil Kit	12	\$68,90
A F G	BL-G1-0009-RS-3H	18W	6500 K	1620	330 × 96	Radar Sensörlü 3 Saat Acil Kit	12	\$68,90
A F G	BL-G1-0005-1H	24W	3000 K	2160	380 × 100	1 Saat Acil Kit	6	\$61,30
A F G	BL-G1-0011-1H	24W	6500 K	2160	380 × 100	1 Saat Acil Kit	6	\$61,30
A F G	BL-G1-0017-1H	24W	4000 K	2160	380 × 100	1 Saat Acil Kit	6	\$61,30
A F G	BL-G1-0005	24W	3000 K	2160	380 × 100	-	6	\$39,80
A F G	BL-G1-0017	24W	4000 K	2160	380 × 100	-	6	\$39,80
A F G	BL-G1-0011	24W	6500 K	2160	380 × 100	-	6	\$39,80
A F G	BL-G1-0005-RS	24W	3000 K	2160	380 × 100	Radar Sensörlü	6	\$49,00
A F G	BL-G1-0017-RS	24W	4000 K	2160	380 × 100	Radar Sensörlü	6	\$49,00
A F G	BL-G1-0011-RS	24W	6500 K	2160	380 × 100	Radar Sensörlü	6	\$49,00
A F G	BL-G1-0005-RS-1H	24W	3000 K	2160	380 × 100	Radar Sensörlü 1 Saat Acil Kit	6	\$65,80
A F G	BL-G1-0017-RS-1H	24W	4000 K	2160	380 × 100	Radar Sensörlü 1 Saat Acil Kit	6	\$65,80
A F G	BL-G1-0011-RS-1H	24W	6500 K	2160	380 × 100	Radar Sensörlü 1 Saat Acil Kit	6	\$65,80
A F G	BL-G1-0005-3H	24W	3000 K	2160	380 × 100	3 Saat Acil Kit	6	\$69,60
A F G	BL-G1-0011-3H	24W	6500 K	2160	380 × 100	3 Saat Acil Kit	6	\$69,60
A F G	BL-G1-0017-3H	24W	4000 K	2160	380 × 100	3 Saat Acil Kit	6	\$69,60
A F G	BL-G1-0005-RS-3H	24W	3000 K	2160	380 × 100	Radar Sensörlü 3 Saat Acil Kit	6	\$76,20
A F G	BL-G1-0017-RS-3H	24W	4000 K	2160	380 × 100	Radar Sensörlü 3 Saat Acil Kit	6	\$76,20
A F G	BL-G1-0011-RS-3H	24W	6500 K	2160	380 × 100	Radar Sensörlü 3 Saat Acil Kit	6	\$76,20

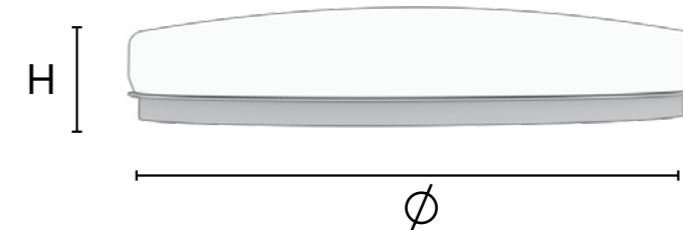

Teknik veri / Datasheet

www.borled.com.tr

## LED NEMLİYER YUVARLAK GLOP TAVAN ARMATÜR LED NEMLİYER ROUND GLOBE CEILING ARMATURE

### Teknik Özellikler Technical Specifications

Gövde : Polikarbonat(PC)  
Body : Polycarbonate

Difüzör : Akrilik  
Diffuser : Acrylic

Renksel Geri Verim : 80  
Color Rendering Index : 80

IP Derecesi : IP65  
IP Rating : IP65

IK Derecesi : IK03  
IK Rating : IK03

Elektriksel Koruma : Sınıf II  
Electrical Protection : Class II

Çalışma Sıcaklığı : -20°C / 45°C  
Operating Temp. Range : -20°C / 45°C

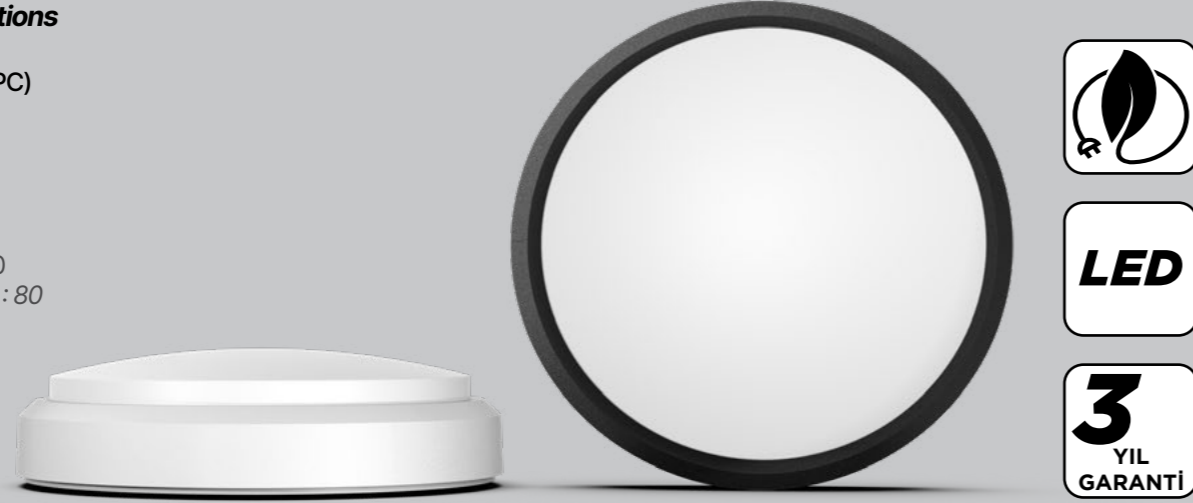

## LED NEMLİYER OVAL GLOP TAVAN ARMATÜR LED NEMLİYER OVAL GLOBE CEILING ARMATURE



### LED NEMLİYER GLOP TAVAN ARMATÜR

Bu armatürler fonksiyonel üst kapaklarından dolayı Glop adını almıştır. Glop ürünler yüzeysel bir aydınlatma yerine daha geniş, detaylı ve homojen aydınlatma sağlamaktadır.

### LED NEMLİYER GLOBE CEILING ARMATURE

These luminaires are named Glop because of their functional top covers. Glop products provide expanse, detailed and homogeneous lighting instead of superficial lighting.

## LED NEMLİYER YUVARLAK GLOP TAVAN ARMATÜR LED NEMLİYER ROUND GLOBE CEILING ARMATURE

Enerji Verimliliği Sınıfı Energy Efficiency Class	Ürün Kodu Product Code	Güç (W) Power	Renk Sıcaklığı (K) Color Temperature	Işık Akısı (Lm) Luminous Flux	Boyutlar (ØxH) mm Dimensions	Renk Color	Koli Adeti Quantity in Carton	Fiyat Price
A+ F	BL-G2-0002	12W	4000 K	1080	175 × 60	Beyaz White	24	\$29,20
A+ F	BL-G2-0003	12W	6500 K	1080	175 × 60	Beyaz White	24	\$29,20
A+ F	BL-G2-0005	15W	4000 K	1350	210 × 60	Beyaz White	12	\$38,40
A+ F	BL-G2-0006	15W	6500 K	1350	210 × 60	Beyaz White	12	\$38,40
A+ F	BL-G2-0008	12W	4000 K	1080	175 × 60	Siyah Black	24	\$29,20
A+ F	BL-G2-0009	12W	6500 K	1080	175 × 60	Siyah Black	24	\$29,20
A+ F	BL-G2-0011	15W	4000 K	1350	210 × 60	Siyah Black	12	\$38,40
A+ F	BL-G2-0012	15W	6500 K	1350	210 × 60	Siyah Black	12	\$38,40

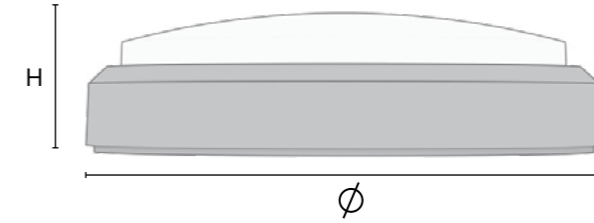

## LED NEMLİYER OVAL GLOP TAVAN ARMATÜR LED NEMLİYER OVAL GLOBE CEILING ARMATURE

Enerji Verimliliği Sınıfı Energy Efficiency Class	Ürün Kodu Product Code	Güç (W) Power	Renk Sıcaklığı (K) Color Temperature	Işık Akısı (Lm) Luminous Flux	Boyutlar (WxLxH) mm Dimensions	Renk Color	Koli Adeti Quantity in Carton	Fiyat Price
A+ F	BL-G3-0002	12W	4000 K	1080	100 × 200 × 60	Beyaz White	36	\$27,80
A+ F	BL-G3-0003	12W	6500 K	1080	100 × 200 × 60	Beyaz White	36	\$27,80
A+ F	BL-G3-0005	15W	4000 K	1350	105 × 230 × 60	Beyaz White	36	\$29,80
A+ F	BL-G3-0006	15W	6500 K	1350	105 × 230 × 60	Beyaz White	36	\$29,80
A+ F	BL-G3-0008	12W	4000 K	1080	100 × 200 × 60	Siyah Black	36	\$27,80
A+ F	BL-G3-0009	12W	6500 K	1080	100 × 200 × 60	Siyah Black	36	\$27,80
A+ F	BL-G3-0011	15W	4000 K	1350	105 × 230 × 60	Siyah Black	36	\$29,80
A+ F	BL-G3-0012	15W	6500 K	1350	105 × 230 × 60	Siyah Black	36	\$29,80

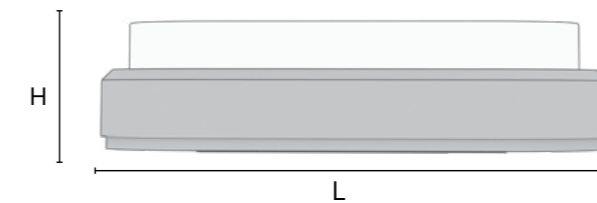

Teknik veri / Datasheet

www.borled.com.tr

## SENSÖRLÜ LED GLOP LED GLOBE WITH SENSOR

### Teknik Özellikler Technical Specifications

Gövde : Polikarbonat (PC)  
Body : Polycarbonate

Cam : Polikarbonat  
Glass : Polycarbonate

Sensör Tipi : P.I.R Sensör  
Sensor Type : P.I.R Sensor

Güç Faktörü : 0.5  
Power Factor : 0.5

Renksel Geri Verim : 80  
Color Rendering Index : 80

Algılama Mesafesi : 2.5-8 m  
Detection Distance : 2.5-8 m

## SENSÖRLÜ LED APLİK LED WALL LUMINAIRE WITH SENSOR



### SENSÖRLÜ GLOP LED

360 derece hareket kızıl ötesi elektronik sensörü ile her yönden algılama ve otomatik aydınlatma. Ürün, gün ışığı algılama sensörü sayesinde gündüz çalışmayıp yalnızca karanlıkta devreye girmektedir. Estetik görünüm ve gözü yormayan soft aydınlatma, sıva üstü kolay montaj.

### SENSORED GLOP LED

360-degree motion detection and automatic illumination from all directions with an infrared electronic sensor. Thanks to the daylight detection sensor, it does not work during the day and is activated only in the dark. Aesthetic appearance and soft lighting that does not tire the eyes, easy surface mounting.

## SENSÖRLÜ LED GLOP LED GLOBE WITH SENSOR

Enerji Verimliliği Sınıfı Energy Efficiency Class	Ürün Kodu Product Code	Güç (W) Power	Renk Sıcaklığı (K) Color Temperature	Işık Akısı (Lm) Luminous Flux	Boyutlar (ØxH) mm Dimensions	Koli Adeti Quantity in Carton	Fiyat Price
A+G	BL-G4-0001-S	12W	3000 K	960	175 × 55	30	\$29,50
A+G	BL-G4-0002-S	12W	4000 K	960	175 × 55	30	\$29,50
A+G	BL-G4-0003-S	12W	6500 K	960	175 × 55	30	\$29,50
A+G	BL-G4-0004-S	15W	3000 K	1200	175 × 55	30	\$30,20
A+G	BL-G4-0005-S	15W	4000 K	1200	175 × 55	30	\$30,20
A+G	BL-G4-0006-S	15W	6500 K	1200	175 × 55	30	\$30,20

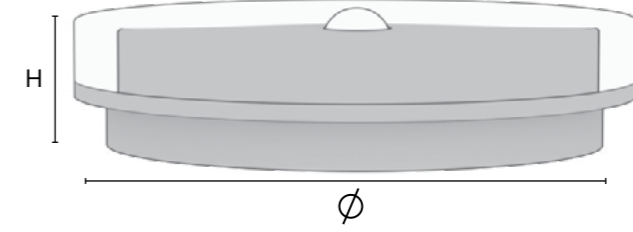

## SENSÖRLÜ LED APLİK LED WALL LUMINAIRE WITH SENSOR

Enerji Verimliliği Sınıfı Energy Efficiency Class	Ürün Kodu Product Code	Güç (W) Power	Renk Sıcaklığı (K) Color Temperature	Işık Akısı (Lm) Luminous Flux	Boyutlar (WxLxH) mm Dimensions	Koli Adeti Quantity in Carton	Fiyat Price
A+G	BL-A1-0001-S	12W	3000 K	960	100 × 200 × 55	30	\$26,30
A+G	BL-A1-0002-S	12W	4000 K	960	100 × 200 × 55	30	\$26,30
A+G	BL-A1-0003-S	12W	6500 K	960	100 × 200 × 55	30	\$26,30
A+G	BL-A1-0004-S	15W	3000 K	1200	100 × 200 × 55	30	\$27,30
A+G	BL-A1-0005-S	15W	4000 K	1200	100 × 200 × 55	30	\$27,30
A+G	BL-A1-0006-S	15W	6500 K	1200	100 × 200 × 55	30	\$27,30

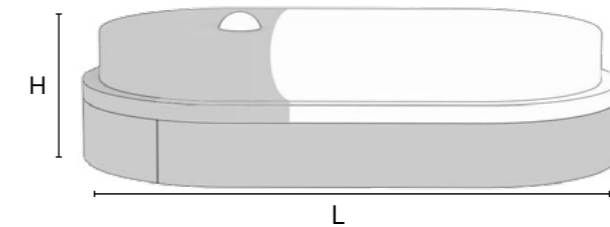

Teknik veri / Datasheet

www.borled.com.tr

HASTANE  
HOSPITAL

borled®  
by borsan

135

KARE LED TAVAN GLOP ARMATÜR  
KARE LED CEILING GLOBE ARMATURE



UFO LED TAVAN GLOP ARMATÜR  
UFO LED CEILING GLOBE ARMATURE



**Teknik Özellikler**  
**Technical Specifications**

Gövde : ABS  
Body : ABS

Cam : S.A.N.  
Glass : S.A.N.

Renksel Geri Verim : 80  
Color Rendering Index : 80

IP Derecesi : IP20  
IP Rating : IP20

Sürücü : On-Board  
Driver : On-Board

İNCİ LED TAVAN GLOP ARMATÜR  
INCI LED CEILING GLOBE ARMATURE



Gövde : DKP Sac  
Body : DKP Metal Sheet

OKYANUS LED TAVAN GLOP ARMATÜR  
OKYANUS LED CEILING GLOBE ARMATURE



İSTANBUL LED TAVAN GLOP ARMATÜR  
ISTANBUL LED CEILING GLOBE ARMATURE



ASOS LED TAVAN GLOP ARMATÜR  
ASOS LED CEILING GLOBE ARMATURE



KARE LED TAVAN GLOP ARMATÜR  
KARE LED CEILING GLOBE ARMATURE

Enerji Verimliliği Sınıfı Energy Efficiency Class	Ürün Kodu Product Code	Güç (W) Power	Renk Sıcaklığı (K) Color Temperature	Işık Akısı (Lm) Luminous Flux	Boyutlar (WxLxH)mm Dimensions	Kutu Adeti Quantity in Box	Koli Adeti Quantity in Carton	Fiyat Price
A G	BL-B1-0007	12W	6500 K	960	250 × 250 × 93	2	24	\$21,80
A G	BL-B1-0008	12W	3000 K	960	250 × 250 × 93	2	24	\$21,80

UFO LED TAVAN GLOP ARMATÜR  
UFO LED CEILING GLOBE ARMATURE

Enerji Verimliliği Sınıfı Energy Efficiency Class	Ürün Kodu Product Code	Güç (W) Power	Renk Sıcaklığı (K) Color Temperature	Işık Akısı (Lm) Luminous Flux	Boyutlar (ØxH) mm Dimensions	Kutu Adeti Quantity in Box	Koli Adeti Quantity in Carton	Fiyat Price
A G	BL-B1-0009	11W	6500 K	880	222 × 99	2	36	\$19,00
A G	BL-B1-0010	11W	3000 K	880	222 × 99	2	36	\$19,00

İNCİ LED TAVAN GLOP ARMATÜR  
INCI LED CEILING GLOBE ARMATURE

Enerji Verimliliği Sınıfı Energy Efficiency Class	Ürün Kodu Product Code	Güç (W) Power	Renk Sıcaklığı (K) Color Temperature	Işık Akısı (Lm) Luminous Flux	Boyutlar (ØxH) mm Dimensions	Kutu Adeti Quantity in Box	Koli Adeti Quantity in Carton	Fiyat Price
A G	BL-B1-0011	11W	6500 K	880	290 × 90	2	16	\$26,50
A G	BL-B1-0012	11W	3000 K	880	290 × 90	2	16	\$26,50

OKYANUS LED TAVAN GLOP ARMATÜR  
OKYANUS LED CEILING GLOBE ARMATURE

Enerji Verimliliği Sınıfı Energy Efficiency Class	Ürün Kodu Product Code	Güç (W) Power	Renk Sıcaklığı (K) Color Temperature	Işık Akısı (Lm) Luminous Flux	Boyutlar (ØxH) mm Dimensions	Kutu Adeti Quantity in Box	Koli Adeti Quantity in Carton	Fiyat Price
A G	BL-B1-0015	24W	6500 K	1560	345 × 50	2	12	\$27,30
A G	BL-B1-0016	24W	3000 K	1560	345 × 50	2	12	\$27,30

İSTANBUL LED TAVAN GLOP ARMATÜR  
ISTANBUL LED CEILING GLOBE ARMATURE

Enerji Verimliliği Sınıfı Energy Efficiency Class	Ürün Kodu Product Code	Güç (W) Power	Renk Sıcaklığı (K) Color Temperature	Işık Akısı (Lm) Luminous Flux	Boyutlar (WxLxH)mm Dimensions	Kutu Adeti Quantity in Box	Koli Adeti Quantity in Carton	Fiyat Price
A G	BL-B1-0017	24W	6500 K	1920	315 × 275 × 90	2	12	\$28,10
A G	BL-B1-0018	24W	3000 K	1920	315 × 275 × 90	2	12	\$28,10

ASOS LED TAVAN GLOP ARMATÜR  
ASOS LED CEILING GLOBE ARMATURE

Enerji Verimliliği Sınıfı Energy Efficiency Class	Ürün Kodu Product Code	Güç (W) Power	Renk Sıcaklığı (K) Color Temperature	Işık Akısı (Lm) Luminous Flux	Boyutlar (WxLxH)mm Dimensions	Kutu Adeti Quantity in Box	Koli Adeti Quantity in Carton	Fiyat Price
A G	BL-B1-0019	12W	6500 K	960	314 × 214 × 88	2	24	\$25,60
A G	BL-B1-0020	12W	3000 K	960	314 × 214 × 88	2	24	\$25,60



Teknik veri / Datasheet

www.borled.com.tr

LED ZÜMRÜT SENSÖRLÜ TAVAN ARMATÜR  
LED ZUMRUT CEILING ARMATURE  
WITH MOTION SENSOR



LED ZÜMRÜT SENSÖRLÜ TAVAN ARMATÜR + ACIL KİT  
LED ZUMRUT CEILING ARMATURE  
WITH MOTION SENSOR + EMERGENCY KIT



ZÜMRÜT TAVAN ARMATÜR (2XE27 DUY)  
ZUMRUT CEILING ARMATURE



ZÜMRÜT SENSÖRLÜ TAVAN ARMATÜR (2XE27 DUY)  
ZUMRUT CEILING ARMATURE WITH MOTION SENSOR



ZÜMRÜT SENSÖRLÜ TAVAN ARMATÜR (2XE27 DUY) + ACIL KİT  
ZUMRUT CEILING ARMATURE WITH MOTION SENSOR + EMERGENCY KIT



**Teknik Özellikler**  
**Technical Specifications**

Gövde DKP Sac  
Body : DKP Sheet Metal

IP Derecesi : IP20  
IP Rating : IP20

Renksel Geri Verim : 80  
Color Rendering Index : 80

**Teknik Özellikler**  
**Technical Specifications**

Gövde DKP Sac  
Body : DKP Sheet Metal

IP Derecesi : IP20  
IP Rating : IP20

Kullanım : Tasarruflu/  
Led Ampul  
Usage : Energy Saving/  
Led Bulb



LED ZÜMRÜT SENSÖRLÜ TAVAN ARMATÜR  
LED ZUMRUT CEILING ARMATURE WITH MOTION SENSOR

Enerji Verimliliği Sınıfı Energy Efficiency Class	Ürün Kodu Product Code	Güç (W) Power	Renk Sıcaklığı (K) Color Temperature	Işık Akısı (Lm) Luminous Flux	Boyutlar (WxLxH)mm Dimensions	Koli Adeti Quantity in Carton	Fiyat Price
A+ F	BL-B1-0021	15W	6500 K	1300	285 × 100	10	\$23,7
A+ F	BL-B1-0022	15W	4000 K	1300	285 × 100	10	\$23,7

LED ZÜMRÜT SENSÖRLÜ TAVAN ARMATÜR + ACIL KİT  
LED ZUMRUT CEILING ARMATURE WITH MOTION SENSOR + EMERGENCY KIT

Enerji Verimliliği Sınıfı Energy Efficiency Class	Ürün Kodu Product Code	Güç (W) Power	Renk Sıcaklığı (K) Color Temperature	Işık Akısı (Lm) Luminous Flux	Boyutlar (ØxH)mm Dimensions	Koli Adeti Quantity in Carton	Fiyat Price
A+ F	BL-B1-0024	15W	6500 K	1300	285 × 100	10	\$35,9
A+ F	BL-B1-0025	15W	4000 K	1300	285 × 100	10	\$35,9

ZÜMRÜT TAVAN ARMATÜR (2XE27 DUY)  
ZUMRUT CEILING ARMATURE

Ürün Kodu Product Code	Renk Color	Boyutlar (ØxH) mm Dimensions	Kutu Adeti Quantity in Box	Koli Adeti Quantity in Carton	Fiyat Price
BR-00243-050	Beyaz	285 × 100	1	10	750,90 TL

ZÜMRÜT SENSÖRLÜ TAVAN ARMATÜR (2XE27 DUY)  
ZUMRUT CEILING ARMATURE WITH MOTION SENSOR

Ürün Kodu Product Code	Renk Color	Boyutlar (ØxH) mm Dimensions	Kutu Adeti Quantity in Box	Koli Adeti Quantity in Carton	Fiyat Price
BR-10243 050	Beyaz	285 × 100	1	10	699,10 TL

ZÜMRÜT SENSÖRLÜ TAVAN ARMATÜR (2XE27 DUY) + ACIL KİT  
ZUMRUT CEILING ARMATURE WITH MOTION SENSOR + EMERGENCY KIT

Ürün Kodu Product Code	Renk Color	Boyutlar (ØxH) mm Dimensions	Kutu Adeti Quantity in Box	Koli Adeti Quantity in Carton	Fiyat Price
BR-C0243-050	Beyaz	285 × 100	1	10	1398,60 TL



Teknik veri / Datasheet

www.borled.com.tr

UFO TAVAN ARMATÜR (1XE27 DUY)  
UFO CEILING ARMATURE



UFOLINE TAVAN ARMATÜR (1XE27 DUY)  
UFOLINE CEILING ARMATURE



**Teknik Özellikler**  
**Technical Specifications**

Gövde ABS  
Body : ABS

Cam : S.A.N  
Glass : S.A.N

Gofraj : Alüminyum  
Embossing : Aluminium

IP Derecesi : IP20  
IP Rating : IP20

Kullanım : Tasarruflu/  
Led Ampul

Usage : Energy Saving/  
Led Bulb

UFOLÜX TAVAN ARMATÜR (1XE27 DUY)  
UFOLUX CEILING ARMATURE



GÜNEŞ TAVAN ARMATÜR (1XE27 DUY)  
GUNES CEILING ARMATURE



VEGA TAVAN ARMATÜR (1XE27 DUY)  
VEGA CEILING ARMATURE



İSİS TAVAN ARMATÜR (1XE27 DUY)  
ISIS CEILING ARMATURE



UFO TAVAN ARMATÜR (1XE27 DUY)  
UFO CEILING ARMATURE

Ürün Kodu Product Code	Renk Color	Boyutlar (ØxH) mm Dimensions	Kutu Adeti Quantity in Box	Koli Adeti Quantity in Carton	Fiyat Price
BR-00203-000	Beyaz	222 × 99	2	36	160,80 TL

UFOLINE TAVAN ARMATÜR (1XE27 DUY)  
UFOLINE CEILING ARMATURE

Ürün Kodu Product Code	Renk Color	Boyutlar (ØxH) mm Dimensions	Kutu Adeti Quantity in Box	Koli Adeti Quantity in Carton	Fiyat Price
BR-00248-000	Beyaz	212 × 98	2	36	150,40 TL

UFOLÜX TAVAN ARMATÜR (1XE27 DUY)  
UFOLUX CEILING ARMATURE

Ürün Kodu Product Code	Renk Color	Boyutlar (ØxH) mm Dimensions	Kutu Adeti Quantity in Box	Koli Adeti Quantity in Carton	Fiyat Price
BR-00203-010	Beyaz	222 × 99	2	36	167,50 TL

GÜNEŞ TAVAN ARMATÜR (1XE27 DUY)  
GUNES CEILING ARMATURE

Ürün Kodu Product Code	Renk Color	Boyutlar (ØxH) mm Dimensions	Kutu Adeti Quantity in Box	Koli Adeti Quantity in Carton	Fiyat Price
BR-00203-020	Beyaz	222 × 99	2	36	165,50 TL

VEGA TAVAN ARMATÜR (1XE27 DUY)  
VEGA CEILING ARMATURE

Ürün Kodu Product Code	Renk Color	Boyutlar (ØxH) mm Dimensions	Kutu Adeti Quantity in Box	Koli Adeti Quantity in Carton	Fiyat Price
BR-00248-010	Beyaz	212 × 98	2	36	148,90 TL

İSİS TAVAN ARMATÜR (1XE27 DUY)  
ISIS CEILING ARMATURE

Ürün Kodu Product Code	Renk Color	Boyutlar (ØxH) mm Dimensions	Kutu Adeti Quantity in Box	Koli Adeti Quantity in Carton	Fiyat Price
BR-00244-000	Beyaz	214 × 314 × 88	2	24	234,20 TL



Teknik veri / Datasheet

www.borled.com.tr

ASOS TAVAN ARMATÜR (1XE27 DUY)  
ASOS CEILING ARMATURE



KARE TAVAN ARMATÜR (1XE27 DUY)  
KARE CEILING ARMATURE



**Teknik Özellikler**  
**Technical Specifications**

Gövde ABS  
Body : ABS

Cam : S.A.N  
Glass : S.A.N

Gofraj : Alüminyum  
Embossing : Aluminium

IP Derecesi : IP20  
IP Rating : IP20

Kullanım : Tasarruflu/  
Led Ampul  
Usage : Energy Saving/  
Led Bulb

KARE SOFT TAVAN ARMATÜR (1XE27 DUY)  
KARE SOFT CEILING ARMATURE



YASMIN TAVAN ARMATÜR (1XE27 DUY)  
YASMIN CEILING ARMATURE



NEPTÜN TAVAN ARMATÜR (1XE27 DUY)  
NEPTUN CEILING ARMATURE



VENÜS TAVAN ARMATÜR (1XE27 DUY)  
VENUS CEILING ARMATURE



ASOS TAVAN ARMATÜR (1XE27 DUY)  
ASOS CEILING ARMATURE

Ürün Kodu Product Code	Renk Color	Boyutlar (WxLxH) mm Dimensions	Kutu Adeti Quantity in Box	Koli Adeti Quantity in Carton	Fiyat Price
BR-00244-010	Beyaz	214 × 314 × 88	2	24	238,50 TL

KARE TAVAN ARMATÜR (1XE27 DUY)  
KARE CEILING ARMATURE

Ürün Kodu Product Code	Renk Color	Boyutlar (WxLxH) mm Dimensions	Kutu Adeti Quantity in Box	Koli Adeti Quantity in Carton	Fiyat Price
BR-00242-000	Beyaz	250 × 250 × 93	2	24	236,50 TL

KARE SOFT TAVAN ARMATÜR (1XE27 DUY)  
KARE SOFT CEILING ARMATURE

Ürün Kodu Product Code	Renk Color	Boyutlar (WxLxH) mm Dimensions	Kutu Adeti Quantity in Box	Koli Adeti Quantity in Carton	Fiyat Price
BR-00242-010	Beyaz	250 × 250 × 93	2	24	245,80 TL

YASMIN TAVAN ARMATÜR (1XE27 DUY)  
YASMIN CEILING ARMATURE

Ürün Kodu Product Code	Renk Color	Boyutlar (ØxH) mm Dimensions	Kutu Adeti Quantity in Box	Koli Adeti Quantity in Carton	Fiyat Price
BR-00245-000	Beyaz	220 × 125	2	36	225,30 TL

NEPTÜN TAVAN ARMATÜR (1XE27 DUY)  
NEPTUN CEILING ARMATURE

Ürün Kodu Product Code	Renk Color	Boyutlar (ØxH) mm Dimensions	Kutu Adeti Quantity in Box	Koli Adeti Quantity in Carton	Fiyat Price
BR-00245-010	Beyaz	220 × 125	2	36	241,60 TL

VENÜS TAVAN ARMATÜR (1XE27 DUY)  
VENUS CEILING ARMATURE

Ürün Kodu Product Code	Renk Color	Boyutlar (ØxH) mm Dimensions	Kutu Adeti Quantity in Box	Koli Adeti Quantity in Carton	Fiyat Price
BR-00201-000	Beyaz	240 × 100	2	36	245,80 TL



Teknik veri / Datasheet

www.borled.com.tr



UZAY TAVAN ARMATÜR (1XE27 DUY)  
UZAY CEILING ARMATURE



İSTANBUL TAVAN ARMATÜR (2XE27 DUY)  
İSTANBUL CEILING ARMATURE



**Teknik Özellikler**  
**Technical Specifications**

Gövde ABS  
Body : ABS

Cam : S.A.N  
Glass : S.A.N

Gofraj : Alüminyum  
Embossing : Aluminium

IP Derecesi : IP20  
IP Rating : IP20

Kullanım : Tasarruflu/  
Led Ampul  
Usage : Energy Saving/  
Led Bulb

BOSPHORUS TAVAN ARMATÜR (2XE27 DUY)  
BOSPHORUS CEILING ARMATURE



GÖK SOFT TAVAN ARMATÜR (2XE27 DUY)  
GOK SOFT CEILING ARMATURE

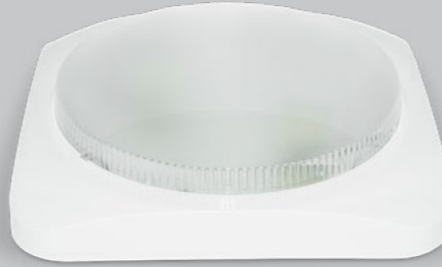

GÖK SIVA ÜSTÜ TAVAN ARMATÜR (2XE27 DUY)  
GOK SURFACE MOUNTED CEILING ARMATURE



OKYANUS TAVAN ARMATÜR (2XE27 DUY)  
OKYANUS CEILING ARMATURE



UZAY TAVAN ARMATÜR (1XE27 DUY)  
UZAY CEILING ARMATURE

Ürün Kodu Product Code	Renk Color	Boyutlar (ØxH) mm Dimensions	Kutu Adeti Quantity in Box	Koli Adeti Quantity in Carton	Fiyat Price
BR-00201-010	Beyaz	240 × 97	2	36	240,60 TL

İSTANBUL TAVAN ARMATÜR (2XE27 DUY)  
İSTANBUL CEILING ARMATURE

Ürün Kodu Product Code	Renk Color	Boyutlar (WxLxH) mm Dimensions	Kutu Adeti Quantity in Box	Koli Adeti Quantity in Carton	Fiyat Price
BR-00247-000	Beyaz	315 × 275 × 90	2	12	305,70 TL

BOSPHORUS TAVAN ARMATÜR (2XE27 DUY)  
BOSPHORUS CEILING ARMATURE

Ürün Kodu Product Code	Renk Color	Boyutlar (WxLxH) mm Dimensions	Kutu Adeti Quantity in Box	Koli Adeti Quantity in Carton	Fiyat Price
BR-00247-010	Beyaz	315 × 275 × 90	2	12	302,20 TL

GÖK SOFT TAVAN ARMATÜR (2XE27 DUY)  
GOK SOFT CEILING ARMATURE

Ürün Kodu Product Code	Renk Color	Boyutlar (WxLxH) mm Dimensions	Kutu Adeti Quantity in Box	Koli Adeti Quantity in Carton	Fiyat Price
BR-00230-010	Beyaz	355 × 355 × 97	1	12	561,20 TL

GÖK SIVA ÜSTÜ TAVAN ARMATÜR (2XE27 DUY)  
GOK SURFACE MOUNTED CEILING ARMATURE

Ürün Kodu Product Code	Renk Color	Boyutlar (WxLxH) mm Dimensions	Kutu Adeti Quantity in Box	Koli Adeti Quantity in Carton	Fiyat Price
BR-00230-000	Beyaz	355 × 355 × 97	1	12	569,50 TL

OKYANUS TAVAN ARMATÜR (2XE27 DUY)  
OKYANUS CEILING ARMATURE

Ürün Kodu Product Code	Renk Color	Boyutlar (ØxH) mm Dimensions	Kutu Adeti Quantity in Box	Koli Adeti Quantity in Carton	Fiyat Price
BR-00231-000	Beyaz	345 × 105	2	12	305,00 TL



OKYANUS SOFT TAVAN ARMATÜR (2XE27 DUY)  
OKYANUS SOFT CEILING ARMATURE



ATLANTIK TAVAN GLOP ARMATÜR (2XE27 DUY)  
ATLANTIK CEILING ARMATURE



**Teknik Özellikler**  
**Technical Specifications**

Gövde ABS  
Body : ABS

Cam : S.A.N  
Glass : S.A.N

Gofraj : Alüminyum  
Embossing : Aluminium

IP Derecesi : IP20  
IP Rating : IP20

Kullanım : Tasarruflu/  
Led Ampul  
Usage : Energy Saving/  
Led Bulb

Gövde DKP Sac  
Body : DKP Sheet Metal

Cam : S.A.N  
Glass : S.A.N

Gofraj : Alüminyum  
Embossing : Aluminium

IP Derecesi : IP20  
IP Rating : IP20

Kullanım : Tasarruflu/  
Led Ampul  
Usage : Energy Saving/  
Led Bulb

İNCI TAVAN ARMATÜR (1XE27 DUY)  
INCI CEILING ARMATURE



YAKUT TAVAN ARMATÜR (1XE27 DUY)  
YAKUT CEILING ARMATURE



OKYANUS SOFT TAVAN ARMATÜR (2XE27 DUY)  
OKYANUS SOFT CEILING ARMATURE

Ürün Kodu Product Code	Renk Color	Boyutlar (ØxH) mm Dimensions	Kutu Adeti Quantity in Box	Koli Adeti Quantity in Carton	Fiyat Price
BR-00231-010	Beyaz	345 × 105	2	12	310,00 TL

ATLANTIK TAVAN GLOP ARMATÜR (2XE27 DUY)  
ATLANTIK CEILING ARMATURE

Ürün Kodu Product Code	Renk Color	Boyutlar (ØxH) mm Dimensions	Kutu Adeti Quantity in Box	Koli Adeti Quantity in Carton	Fiyat Price
BR-00231-020	Beyaz	345 × 105	2	12	316,20 TL

İNCI TAVAN ARMATÜR (1XE27 DUY)  
INCI CEILING ARMATURE

Ürün Kodu Product Code	Renk Color	Boyutlar (ØxH) mm Dimensions	Kutu Adeti Quantity in Box	Koli Adeti Quantity in Carton	Fiyat Price
BR-00206-010	Beyaz	290 × 90	2	16	490,00 TL

YAKUT TAVAN ARMATÜR (1XE27 DUY)  
YAKUT CEILING ARMATURE

Ürün Kodu Product Code	Renk Color	Boyutlar (ØxH) mm Dimensions	Kutu Adeti Quantity in Box	Koli Adeti Quantity in Carton	Fiyat Price
BR-00206-000	Beyaz	290 × 90	2	16	503,50 TL



EKOTA LED DUVAR APLİK  
EKOTA LED WALL LIGHTING FIXTURE



EKOLIGHT LED DUVAR APLİK  
EKOLIGHT LED WALL LIGHTING FIXTURE



### Teknik Özellikler Technical Specifications

Gövde : ABS  
Body : ABS

Cam : S.A.N  
Glass : S.A.N.

Renksel Geri Verim : 80  
Color Rendering Index : 80

IP Derecesi : IP20  
IP Rating : IP20

Sürücü : On-Board  
Driver : On-Board

NEMLİYER LED DUVAR APLİK IP65  
NEMLİYER LED WALL LIGHTING FIXTURE IP65



EKOTA LED DUVAR APLİK  
EKOTA LED WALL LIGHTING FIXTURE

Enerji Verimliliği Sınıfı Energy Efficiency Class	Ürün Kodu Product Code	Güç (W) Power	Renk Sıcaklığı (K) Color Temperature	Işık Akısı (Lm) Luminous Flux	Boyutlar (WxLxH)mm Dimensions	Kutu Adeti Quantity in Box	Koli Adeti Quantity in Carton	Fiyat Price
A+G	BL-B1-0001	12W	6500 K	960	150 x 260 x 50	2	36	\$16,40
A+G	BL-B1-0002	12W	3000 K	960	150 x 260 x 50	2	36	\$16,40

EKOLIGHT LED DUVAR APLİK  
EKOLIGHT LED WALL LIGHTING FIXTURE

Enerji Verimliliği Sınıfı Energy Efficiency Class	Ürün Kodu Product Code	Güç (W) Power	Renk Sıcaklığı (K) Color Temperature	Işık Akısı (Lm) Luminous Flux	Boyutlar (WxLxH)mm Dimensions	Kutu Adeti Quantity in Box	Koli Adeti Quantity in Carton	Fiyat Price
A+G	BL-B1-0003	12W	6500 K	960	168 x 276 x 50	2	36	\$16,70
A+G	BL-B1-0004	12W	3000 K	960	168 x 276 x 50	2	36	\$16,70

NEMLİYER LED DUVAR APLİK  
NEMLİYER LED WALL LIGHTING FIXTURE

Enerji Verimliliği Sınıfı Energy Efficiency Class	Ürün Kodu Product Code	Güç (W) Power	Renk Sıcaklığı (K) Color Temperature	Işık Akısı (Lm) Luminous Flux	Boyutlar (WxLxH)mm Dimensions	Kutu Adeti Quantity in Box	Koli Adeti Quantity in Carton	Fiyat Price
A+G	BL-B1-0005	12W	6500 K	750	135 x 235 x 55	2	36	\$17,40
A+G	BL-B1-0006	12W	3000 K	750	135 x 235 x 55	2	36	\$17,40



Teknik veri / Datasheet

www.borled.com.tr

ŞAH DUVAR APLİK ARMATÜR (1XE27 DUY)  
SAH WALL LUMINAIRE



IP Derecesi : IP40  
IP Rating : IP40

AYNA ÜSTÜ DUVAR APLİK ARMATÜR (2XE14 DUY)  
AYNA USTU WALL LUMINAIRE



**Teknik Özellikler**  
**Technical Specifications**

Gövde ABS  
Body : ABS

Cam : S.A.N  
Glass : S.A.N

IP Derecesi : IP20  
IP Rating : IP20

Kullanım : Tasarruflu/  
Led Ampul  
Usage : Energy Saving/  
Led Bulb

ŞAH DUVAR APLİK ARMATÜR (1XE27 DUY)  
SAH WALL LUMINAIRE

Ürün Kodu Product Code	Renk Color	Boyutlar (WxLxH) mm Dimensions	Kutu Adeti Quantity in Box	Koli Adeti Quantity in Carton	Fiyat Price
BR-00309-000	Beyaz	150 × 87 × 230	1	48	180,20 TL

AYNA ÜSTÜ DUVAR APLİK ARMATÜR (2XE14 DUY)  
AYNA USTU WALL LUMINAIRE

Ürün Kodu Product Code	Renk Color	Boyutlar (WxLxH) mm Dimensions	Kutu Adeti Quantity in Box	Koli Adeti Quantity in Carton	Fiyat Price
BR-00235-000	Beyaz	290 × 85 × 74	1	48	186,00 TL

KRALIÇE DUVAR APLİK ARMATÜR (1XE27 DUY)  
KRALICE WALL LUMINAIRE



EKOTA DUVAR APLİK ARMATÜR (1XE27 DUY)  
EKOTA WALL LUMINAIRE



KRALIÇE DUVAR APLİK ARMATÜR (1XE27 DUY)  
KRALICE WALL LUMINAIRE

Ürün Kodu Product Code	Renk Color	Boyutlar (WxLxH) mm Dimensions	Kutu Adeti Quantity in Box	Koli Adeti Quantity in Carton	Fiyat Price
BR-00306-000	Beyaz	166 × 236 × 114	2	36	176,60 TL

EKOTA DUVAR APLİK ARMATÜR (1XE27 DUY)  
EKOTA WALL LUMINAIRE

Ürün Kodu Product Code	Renk Color	Boyutlar (WxLxH) mm Dimensions	Kutu Adeti Quantity in Box	Koli Adeti Quantity in Carton	Fiyat Price
BR-00307-000	Beyaz	276 × 168 × 100	2	36	183,50 TL

EKOLIGHT DUVAR APLİK ARMATÜR (1XE27 DUY)  
EKOLIGHT WALL LUMINAIRE



EKOSOFT DUVAR APLİK ARMATÜR (1XE27 DUY)  
EKOSOFT WALL LUMINAIRE



EKOLIGHT DUVAR APLİK ARMATÜR (1XE27 DUY)  
EKOLIGHT WALL LUMINAIRE

Ürün Kodu Product Code	Renk Color	Boyutlar (WxLxH) mm Dimensions	Kutu Adeti Quantity in Box	Koli Adeti Quantity in Carton	Fiyat Price
BR-00246-000	Beyaz	276 × 168 × 100	2	36	208,00 TL

EKOSOFT DUVAR APLİK ARMATÜR (1XE27 DUY)  
EKOSOFT WALL LUMINAIRE

Ürün Kodu Product Code	Renk Color	Boyutlar (WxLxH) mm Dimensions	Kutu Adeti Quantity in Box	Koli Adeti Quantity in Carton	Fiyat Price
BR-00246-010	Beyaz	276 × 168 × 100	2	36	197 TL



KRAL DEKORATİF DUVAR APLİK ARMATÜR (1XE27 DUY)  
KRAL DECORATIVE WALL LUMINAIRE



KRAL KAFESLİ DUVAR APLİK ARMATÜR (1XE27 DUY)  
KRAL CAGED WALL LUMINAIRE



TAÇ DUVAR APLİK ARMATÜR (1XE27 DUY)  
TAC WALL LUMINAIRE



PETEK DEKORATİF DUVAR APLİK ARMATÜR (1XE27 DUY)  
PETEK DECORATIVE WALL LUMINAIRE



PETEK KAFESLİ DUVAR APLİK ARMATÜR (1XE27 DUY)  
PETEK CAGED WALL LUMINAIRE



NEMLİYER DEKORATİF DUVAR APLİK ARMATÜR  
NEMLİYER DECORATIVE WALL LUMINAIRE



IP65

NEMLİYER KAFESLİ DEKORATİF DUVAR APLİK ARMATÜR  
NEMLİYER CAGED WALL LUMINAIRE



IP65

### Teknik Özellikler Technical Specifications

Gövde ABS  
Body : ABS

Cam : S.A.N  
Glass : S.A.N

IP Derecesi : IP44  
IP Rating : IP44

Kullanım : Tasarruflu/  
Led Ampul  
Usage : Energy Saving/  
Led Bulb

KRAL DEKORATİF DUVAR APLİK ARMATÜR (1XE27 DUY)  
KRAL DECORATIVE WALL LUMINAIRE

Ürün Kodu Product Code	Renk Color	Boyutlar (WxLxH) mm Dimensions	Kutu Adeti Quantity in Box	Koli Adeti Quantity in Carton	Fiyat Price
BR-00220-000	Beyaz	260 × 165 × 102	1	20	333,40 TL

KRAL KAFESLİ DUVAR APLİK ARMATÜR (1XE27 DUY)  
KRAL CAGED WALL LUMINAIRE

Ürün Kodu Product Code	Renk Color	Boyutlar (WxLxH) mm Dimensions	Kutu Adeti Quantity in Box	Koli Adeti Quantity in Carton	Fiyat Price
BR-00220-001	Beyaz	260 × 165 × 110	1	20	347,40 TL

TAÇ DUVAR APLİK ARMATÜR (1XE27 DUY)  
TAC WALL LUMINAIRE

Ürün Kodu Product Code	Renk Color	Boyutlar (WxLxH) mm Dimensions	Kutu Adeti Quantity in Box	Koli Adeti Quantity in Carton	Fiyat Price
BR-00249-000	Beyaz	240 × 120 × 120	2	36	104,10 TL

PETEK DEKORATİF DUVAR APLİK ARMATÜR (1XE27 DUY)  
PETEK DECORATIVE WALL LUMINAIRE

Ürün Kodu Product Code	Renk Color	Boyutlar (WxLxH) mm Dimensions	Kutu Adeti Quantity in Box	Koli Adeti Quantity in Carton	Fiyat Price
BR-00220-010	Beyaz	260 × 165 × 102	1	20	333,30 TL

PETEK KAFESLİ DUVAR APLİK ARMATÜR (1XE27 DUY)  
PETEK CAGED WALL LUMINAIRE

Ürün Kodu Product Code	Renk Color	Boyutlar (WxLxH) mm Dimensions	Kutu Adeti Quantity in Box	Koli Adeti Quantity in Carton	Fiyat Price
BR-00220-011	Beyaz	260 × 165 × 110	1	20	347,60 TL

NEMLİYER DEKORATİF DUVAR APLİK ARMATÜR (1XE27 DUY)  
NEMLİYER DECORATIVE WALL LUMINAIRE

Ürün Kodu Product Code	Renk Color	Boyutlar (WxLxH) mm Dimensions	Kutu Adeti Quantity in Box	Koli Adeti Quantity in Carton	Fiyat Price
BR-00222-000	Beyaz	235 × 135 × 107	1	20	243,60 TL

NEMLİYER KAFESLİ DEKORATİF DUVAR APLİK ARMATÜR (1XE27 DUY)  
NEMLİYER CAGED WALL LUMINAIRE

Ürün Kodu Product Code	Renk Color	Boyutlar (ØxH) mm Dimensions	Kutu Adeti Quantity in Box	Koli Adeti Quantity in Carton	Fiyat Price
BR-00222-001	Beyaz	235 × 135 × 120	1	20	260,60 TL



# LED ACİL ÇIKIŞ ARMATÜRÜ

## LED EMERGENCY EXIT LUMINAIRE

### Teknik Özellikler

#### Technical Specifications

Gövde : ABS  
Body : ABS

Difüzör : Akrilik  
Diffuser : Acrylic

IP Derecesi : IP40  
IP Rating : IP40

Montaj : Sıva üstü  
Mounting : Surface Mounted

Pil Türü : Nikel-Kadmium  
Battery Type : Ni-Cd

Acilde kullanım : 3 Saat  
Emergency Use : 3 Hours



### ACİL ÇIKIŞ ARMATÜRÜ

Kalite standartlarına uygun gövde ve difüzör yapısı, LED aydınlatması ve şebeke voltaj dalgalanmalarına karşı Ni-Cd pil direnci ile acil durumlarda kılavuz işaretlemeler için tasarlanmış güvenilir bir armatürdür.

### EMERGENCY EXIT LUMINAIRE

It is a reliable luminaire designed for guide markings in emergency conditions with its body and diffuser structure by quality standards, LED lighting and Ni-Cd battery resistance to mains voltage fluctuations.



154



155

TURQUALITY®

# LED ACİL ÇIKIŞ ARMATÜRÜ

## LED EMERGENCY EXIT LUMINAIRE

Ürün Kodu Product Code	Güç (W) Power	Işık Akısı (Lm) Luminous Flux	Giriş Voltajı Input Voltage	Boyutlar (WxLxH) mm Dimensions	Koli Adeti Quantity in Carton	Fiyat Price
BL-AC-0002	3W	120	220-230 V AC	195 x 325 x 55	20	\$52

### AŞAĞI YÖNLÜ



Ürün Kodu Product Code	Güç (W) Power	Işık Akısı (Lm) Luminous Flux	Giriş Voltajı Input Voltage	Boyutlar (WxLxH) mm Dimensions	Koli Adeti Quantity in Carton	Fiyat Price
BL-AC-0003	3W	120	220-230 V AC	195 x 325 x 55	20	\$52

### İLERİ YÖNLÜ



Ürün Kodu Product Code	Güç (W) Power	Işık Akısı (Lm) Luminous Flux	Giriş Voltajı Input Voltage	Boyutlar (WxLxH) mm Dimensions	Koli Adeti Quantity in Carton	Fiyat Price
BL-AC-0004	3W	120	220-230 V AC	195 x 325 x 55	20	\$52

### YUKARI YÖNLÜ

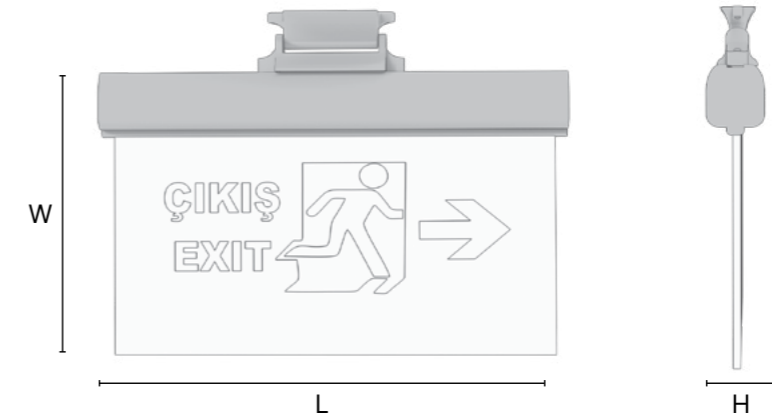

Teknik veri / Datasheet

www.borled.com.tr

# LED ACİL ÇIKIŞ ARMATÜRÜ

## LED EMERGENCY EXIT LUMINAIRE

### Teknik Özellikler

#### Technical Specifications

Gövde : Alüminyum  
Body : Aluminium

Difüzör : Akriiklik  
Diffuser : Acrylic

IP Derecesi : IP20  
IP Rating : IP20

Montaj : Sıva üstü  
Mounting : Surface Mounted

Pil Türü : Nikel-Kadmiyum  
Battery Type : Ni-Cd

Acilde kullanım : 3 Saat  
Emergency Use : 3 Hours



### ACİL ÇIKIŞ ARMATÜRÜ

Kalite standartlarına uygun gövde ve difüzör yapısı, LED aydınlatması ve şebeke voltaj dalgalanmalarına karşı Ni-Cd pil direnci ile acil durumlarda kılavuz işaretlemeler için tasarlanmış güvenilir bir armatürdür.

### EMERGENCY EXIT LUMINAIRE

It is a reliable luminaire designed for guide markings in emergency conditions with its body and diffuser structure by quality standards, LED lighting and Ni-Cd battery resistance to mains voltage fluctuations.

# LED ACİL ÇIKIŞ ARMATÜRÜ

## LED EMERGENCY EXIT LUMINAIRE

TURQUALITY®

Ürün Kodu Product Code	Ürün Görseli Product Image	Güç (W) Power	Işık Akısı (Lm) Luminous Flux	Giriş Voltajı Input Voltage	Boyutlar (WxLxH) mm Dimensions	Koli Adeti Quantity in Carton	Fiyat Price
BL-AC-0005		3W	120	220-230 V AC	155 x 325 x 22	20	\$21,40
BL-AC-0006		3W	120	220-230 V AC	155 x 325 x 22	20	\$21,40
BL-AC-0007		3W	120	220-230 V AC	155 x 325 x 22	20	\$21,40
BL-AC-0008		3W	120	220-230 V AC	155 x 325 x 22	20	\$21,40
BL-AC-0009		3W	120	220-230 V AC	155 x 325 x 22	20	\$21,40
BL-AC-0010		3W	120	220-230 V AC	155 x 325 x 22	20	\$21,40

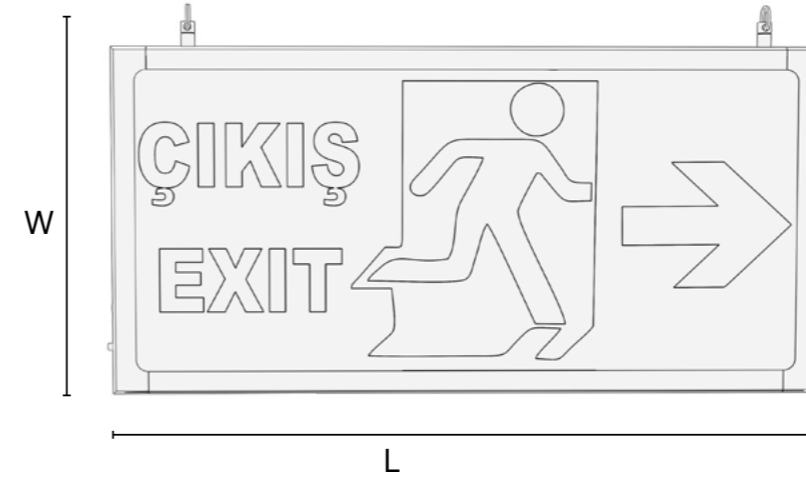

HASTANE  
HOSPITAL

borled®  
by borsan

157

Teknik veri / Datasheet

www.borled.com.tr

# DOKUNMATİK MASA AYDINLATMASI

## TOUCH TABLE LIGHTING

### Teknik Özellikler

#### Technical Specifications

Gövde : Metal  
Body : Metal

Renkler : Saten, Bakır, Krom, Altın  
Colors : Satin, Copper, Chrome, Gold

IP Derecesi : IP20  
IP Rating : IP20

Çalışma Voltajı : 3.7V  
Operating Voltage : 3.7V

Pil Türü : 18650 Lityum Pil  
Battery Type : 18650 Lithium Battery



### DOKUNMATİK MASA AYDINLATMASI

Metalik mantar şekliyle sevimli ve şık! Masa üstü dokunmatik ayarlanabilir karartma özelliği odanızın atmosferini değiştirir ve aynı zamanda bir okuma lambası olarak da kullanışlıdır. USB şarj portlu fonksiyonel LED Masa Lambası

### TOUCH TABLE LIGHTING

Cute and stylish with its metallic mushroom shape! The tabletop touch adjustable dimming feature changes the atmosphere of your room and is also useful as a reading lamp. Functional LED Table Lamp with USB charging port

# DOKUNMATİK MASA AYDINLATMASI

## TOUCH TABLE LIGHTING

TURQUALITY®

Ürün Kodu Product Code	Güç (W) Power	Işık Akısı (Lm) Luminous Flux	Renk Sıcaklığı (K) Color Temperature	Boyutlar (WxLxH) mm Dimensions	Renkler Colors	Koli Adeti Quantity in Carton	Fiyat Price
BL-DL-0001	5W	120	3000 K	90 × 215	Saten Satin	30	\$28,20
BL-DL-0002	5W	120	4000 K	90 × 215	Saten Satin	30	\$28,20
BL-DL-0003	5W	120	6500 K	90 × 215	Saten Satin	30	\$28,20
BL-DL-0004	5W	120	3000 K	90 × 215	Krom Chrome	30	\$28,20
BL-DL-0005	5W	120	4000 K	90 × 215	Krom Chrome	30	\$28,20
BL-DL-0006	5W	120	6500 K	90 × 215	Krom Chrome	30	\$28,20
BL-DL-0007	5W	120	3000 K	90 × 215	Altın Gold	30	\$28,20
BL-DL-0008	5W	120	4000 K	90 × 215	Altın Gold	30	\$28,20
BL-DL-0009	5W	120	6500 K	90 × 215	Altın Gold	30	\$28,20
BL-DL-0010	5W	120	3000 K	90 × 215	Bakır Copper	30	\$28,20
BL-DL-0011	5W	120	4000 K	90 × 215	Bakır Copper	30	\$28,20
BL-DL-0012	5W	120	6500 K	90 × 215	Bakır Copper	30	\$28,20





# DEDEKTÖR VE SENSÖRLER

## DETECTOR AND SENSORS

### Teknik Özellikler

#### Technical Specifications

Gövde : ABS  
Body : ABS

Gövde Renkleri : Beyaz  
Body Colors : White

Kapak : ABS  
Cover : ABS

Kapak Rengi : Beyaz  
Cover Color : White

İlk Derecesi : IK07  
IK Rating : IK07

Çalışma Sıcaklığı : -20 C / 45 C  
Operating Temp. Range : -20 C / 45 C

Çalışma Gerilimi : 220-240 V AC  
Operating Voltage Range : 220-240 V AC



### DEDEKTÖR VE SENSÖRLER

Ev ve iş yerlerinde yangın emniyeti, genel amaçlı güvenlik unsurları ve otomatik aydınlatma fonksiyonları ile enerji tasarrufu için tercih edilen ürünlerdir. Sensör, belirli dış uyarıları algılayan ve ayırt edici bir şekilde yanıt veren bir cihazdır. Dedektör, belirli bir maddeyi veya fiziksel fenomeni kaydedebilen bir cihazdır.

### DETECTOR AND SENSORS

They are the products preferred for energy saving with fire safety, general-purpose security elements and automatic lighting functions in homes and workplaces. A sensor is a device that detects certain external stimuli and responds in a distinctive way. A detector is a device that can record a particular substance or physical phenomenon.

### MİNİ SENSÖR

#### MINI SENSOR

Ürün Kodu Product Code	Güç (W) Power	Akım Flow	Montaj Yüksekliği Mounting Height	Çalışma Sıcaklığı Operating Temp.	Algılama Mesafesi Detection Distance	Giriş Voltajı Input Voltage	Frekans Frequency	Koli Adeti Quantity in Carton	Fiyat Price
BR-MS001	1200W	Max 10 A	2.2 - 4m	-10°C - +40°C	Max 8m	220-240	50-60Hz	200	\$12,00

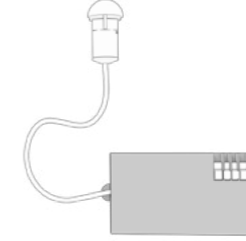

### SIVA ALTI 360° SENSÖR

#### FLUSH MOUNTED 360° SENSOR

Ürün Kodu Product Code	Giriş Voltajı Input Voltage	Frekans Frequency	Montaj Yüksekliği Mounting Height	Çalışma Sıcaklığı Operating Temp.	Anma Yüğü Rated Load	Algılama Derecesi Detection Degree	Algılama Mesafesi Detection Distance	Koli Adeti Quantity in Carton	Fiyat Price
BR-SA360	220-240V AC	50Hz	2.5 - 3.5 m	-20°C - +40°C	"Max 1200W Tungsten Max 300W Florasan"	360°	Max 6m	100	\$12



### SIVA ÜSTÜ 360° SENSÖR

#### SURFACE MOUNTED 360° SENSOR

Ürün Kodu Product Code	Giriş Voltajı Input Voltage	Frekans Frequency	Montaj Yüksekliği Mounting Height	Çalışma Sıcaklığı Operating Temp.	Anma Yüğü Rated Load	Algılama Derecesi Detection Degree	Algılama Mesafesi Detection Distance	Koli Adeti Quantity in Carton	Fiyat Price
BR-SU360	220-240V AC	50Hz	2.2 - 4 m	-20°C - +40°C	Max 1200W Tungsten Max 300W Florasan"	360°	Max 8m	100	\$12

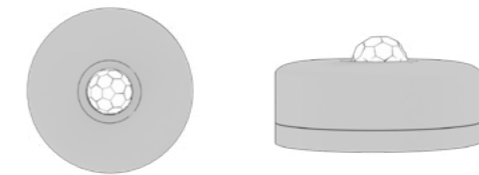

### RADAR SENSÖR

#### RADAR SENSOR

Ürün Kodu Product Code	Güç (W) Power	Akım Flow	Koruma Sınıfı Protection Class	Algılama Mesafesi Detection Distance	Giriş Voltajı Input Voltage	Frekans Frequency	Koli Adeti Quantity in Carton	Fiyat Price
BR-RS001	1200W	10A	IP20	2-8m	220-240	50-60Hz	200	\$15

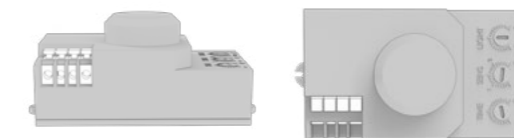

Teknik veri / Datasheet

www.borled.com.tr

# YERLİ ÜRÜN HAVA KAÇAK TESPİT CİHAZI

## HOMEMADE PRODUCT AIR LEAKAGE DETECTION DEVICE

### Teknik Özellikler

#### Technical Specifications

Gövde : ABS  
Body : ABS

Mikrofon Sayısı : 4 adet Dijital MEMS Mikrofon

Frekans Bandı : 20-60 kHz

Batarya : Şarj Edilebilir Batarya / 4 Saat Kullanım

Ağırlık (Pil Dahil) : 610gr

Görüş Alanı : 65°

Çözünürlük : 480x272(130.560 piksel)

Dokunmatik Ekran : Kapasitif

Akustik Görüntü : Evet

dB Kazanç Grafik Geçisi : Otomatik

Hafıza : Sd Kart Soketi

Konum Kaydetme : Fotoğraflandırma ve Not Yazma

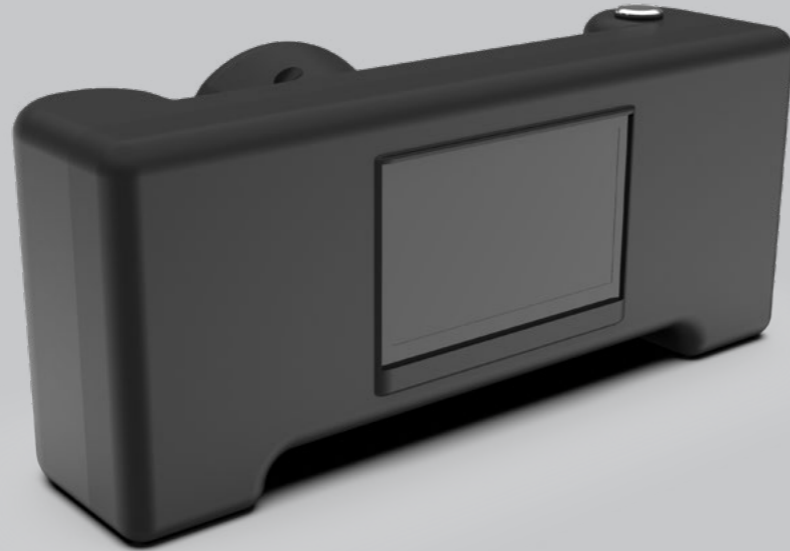

### YERLİ ÜRÜN HAVA KAÇAK TESPİT CİHAZI

Entegre kameralı ultrasonik hava kaçak dedektörü tamamen yerli üretimdir. Endüstriyel ve gürültülü ortamlarda akustik huni yapısı ile gelişmiş ve hassas kaçak tespiti için tasarlanmıştır. Sağlam gövde ve ergonomik yapısı ile düşük ağırlıkta ve dokunmatik ekran üzerinden kolay kullanım özelliğine sahiptir. Kaçak verilerini depolama ve SD kart üzerinden bilgisayara aktarma özelliğinin yanı sıra görüntülenen kaçak oranını l/dk cinsinden direkt görüntüleme, maliyet hesaplama ve raporlama özelliklerine sahip fonksiyonel bir cihazdır.

### HOMEMADE PRODUCT AIR LEAKAGE DETECTION DEVICE

Ultrasonic air leak detector with integrated camera is completely domestic production. It is designed for advanced and sensitive leak detection with acoustic funnel structure in industrial and noisy environments. Robust body and ergonomic structure with low weight and easy operation via touch screen. It is a functional device with the ability to store leakage data and transfer it to a computer via SD card, as well as direct display of the displayed leakage rate in l / min, cost calculation and reporting.

### YERLİ ÜRÜN HAVA KAÇAK TESPİT CİHAZI

#### HOMEMADE PRODUCT AIR LEAKAGE DETECTION DEVICE

Boru sistemlerindeki sızıntılar, hava kaçaklarında (örneğin korozyon, sızıntı yapan vida bağlantıları vb.) ultrasonik aralıkta bir miktar gürültü üretir. HAVA KAÇAK TESPİT CİHAZI, insan kulağının birkaç metre mesafeden bile duyamayacağı bu tipteki en küçük kaçakları gürültülü ortama rağmen tespit eder ve ultrason verilerini duyulabilir ve izlenebilir frekanslara dönüştürür. Son derece hassas sensör teknolojisi ile bu tür kaçakların (örneğin basınçlı hava sistemleri, endüstriyel tesislerdeki pnömomatik sistemler) tespitinde ileri düzeyde destek sağlar. Entegre sistemleri sayesinde lazer işaretleyici bir hedefleme cihazı olarak işlev görür, sızıntı daha hassas bir şekilde konumlandırılabilir ve lokalize edilebilir. Sızıntı verileri bir SD kart üzerinden aktarılabilir ve bulunan sızıntıları belgelemek için net raporlar oluşturulabilir.

Leaks in piping systems, air leaks (e.g. corrosion, leaking screw connections, etc.) produce some noise in the ultrasonic range. The AIR LEAK DETECTOR detects the smallest leaks of this type, which the human ear cannot hear even at a distance of several metres, despite the noisy environment and converts the ultrasound data into audible and traceable frequencies. With its highly sensitive sensor technology, it provides advanced support in the detection of such leaks (e.g. compressed air systems, pneumatic systems in industrial plants). Thanks to its integrated systems, the laser pointer functions as a targeting device and the leak can be more precisely located and localised. Leak data can be transferred via an SD card and clear reports can be generated to document found leaks.

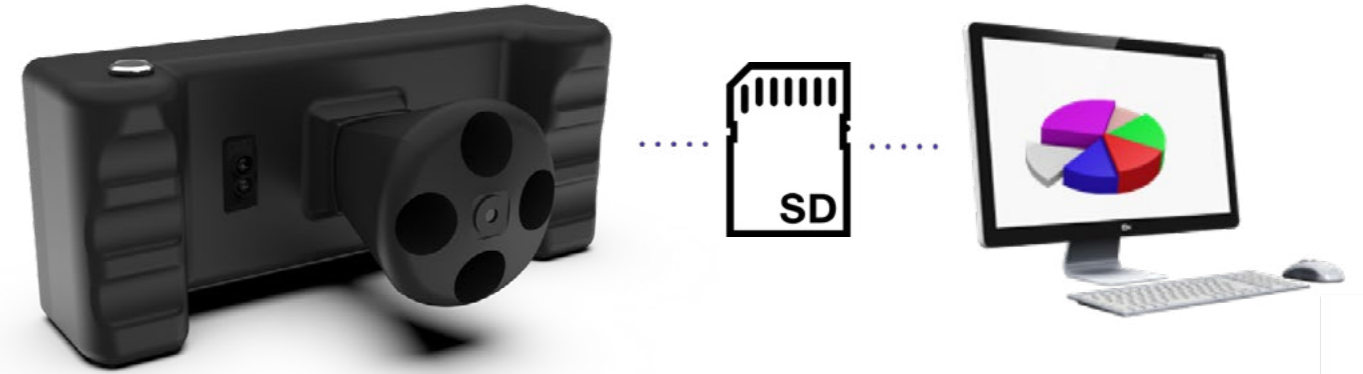

Seviye hassasiyetini otomatik olarak ayarlar.

Endüstriyel ortamdan ve ortam gürültüsünden etkilenmeden güvenilir ölçüm ve yaklaşık ve en doğru kaçak hava maliyetleri gösterilmesini sağlar.

Toplam kaçak miktarınız ve toplam kaçak maliyetleriniz hakkında genel bir bakış sağlar ve sizi gerekli denetimlere hazırlar.

Automatically adjusts the level sensitivity.

Reliable measurement and display of approximate and most accurate leakage air costs without interference from the industrial environment and ambient noise.

Provides an overview of your total leakage amount and total leakage costs and prepares you for necessary audits.

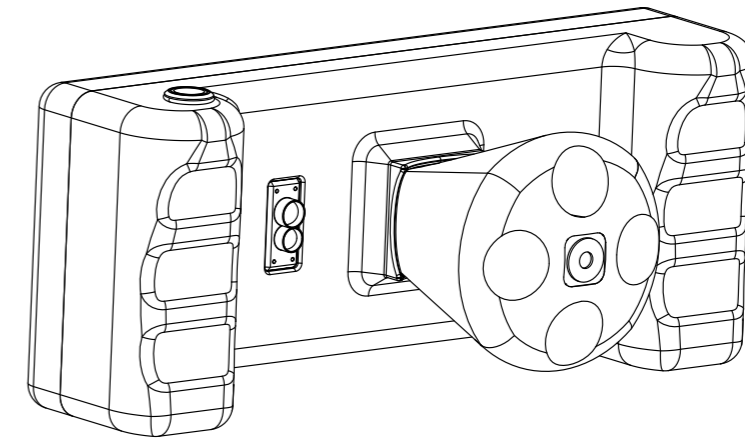

Teknik veri / Datasheet

www.borled.com.tr

## SLİM ACİL AYDINLATMA KİTİ SLIM EMERGENCY LIGHTING KIT



### Teknik Özellikler Technical Specifications

Gövde : ABS  
Body : ABS

Cam: Polikarbon Cam  
Glass: Polycarbon Glass

Giriş Gerilimi : 220-240 V AC  
Input Voltage: 220-240 V AC

Çıkış Gerilimi : 3-150 V DC  
Output Voltage : 3-150 V DC

Çalışma Frekansı : 50/60 Hz  
Operating Frequency : 50/60 Hz

Pil Tipi : Li-Ion  
Battery Type : Li-Ion

Şarj Süresi : 24 saat  
Charging Time : 24 hours

IP Derecesi : IP20  
IP Rating : IP20

Çalışma Sıcaklığı : -20°C / 55°C  
Operating Temperature Range : -20°C / 55°C

## KOMPAKT ACİL AYDINLATMA KİTİ COMPACT EMERGENCY LIGHTING KIT

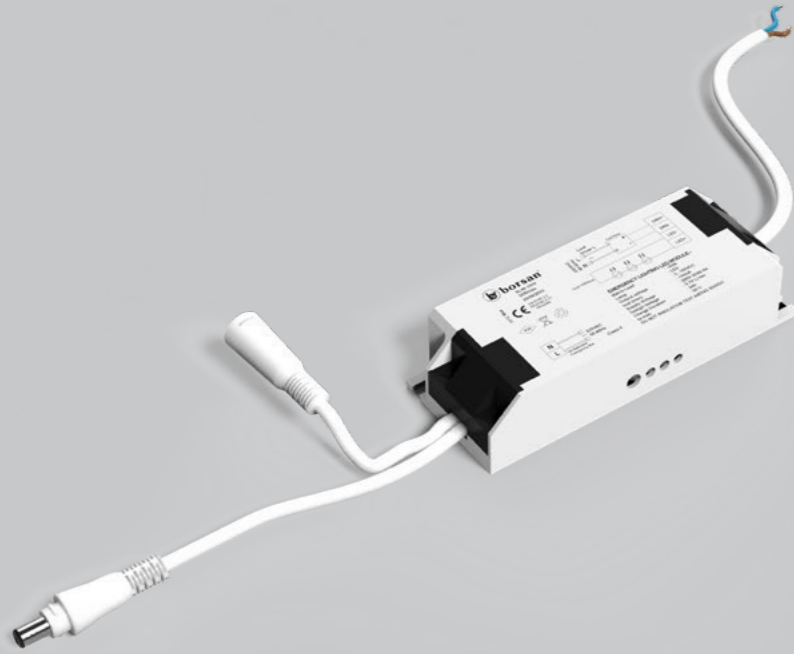

### ACİL AYDINLATMA KİTİ

Bu acil durum dönüştürme kitleri, 3 saatlik acil durum çözümleri gerektiren çeşitli ürünlerle eşleştirilmek üzere tasarlanmıştır.

### EMERGENCY LIGHTING KIT

These emergency conversion kits are designed to be paired with a variety of products that require 3-hour emergency solutions.

## SLİM ACİL AYDINLATMA KİTİ SLIM EMERGENCY LIGHTING KIT

Ürün Kodu Product Code	Güç (W) Power	Çıkış Akımı (max) Color Temperature	Pil Kapasitesi Battery Capacity	Çalışma Süresi (max) Operation Time	Bağlantı Tipi Connection Type	Boyutlar (WxLxH) mm Dimensions	Koli Adeti Quantity in Carton	Fiyat Price
132-1453	50W	<30mA	2600mA	3 saat 3 hours	Klemens Terminal	31 X 210 X 25	50	\$29,40

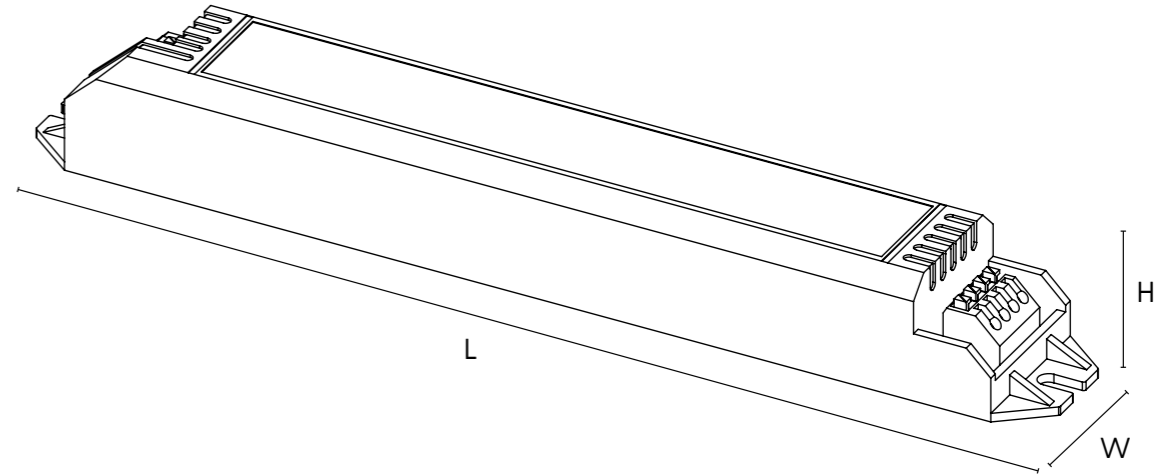

## KOMPAKT ACİL AYDINLATMA KİTİ COMPACT EMERGENCY LIGHTING KIT

Ürün Kodu Product Code	Güç (W) Power	Çıkış Akımı (max) Color Temperature	Pil Kapasitesi Battery Capacity	Çalışma Süresi (max) Operation Time	Bağlantı Tipi Connection Type	Boyutlar (WxLxH) mm Dimensions	Koli Adeti Quantity in Carton	Fiyat Price
132-1454	50W	<30mA	2200mA	3 saat 3 hours	Dişi/Erkek Konnektör Female/Male Connector	42 X 110 X 25	50	\$16,90

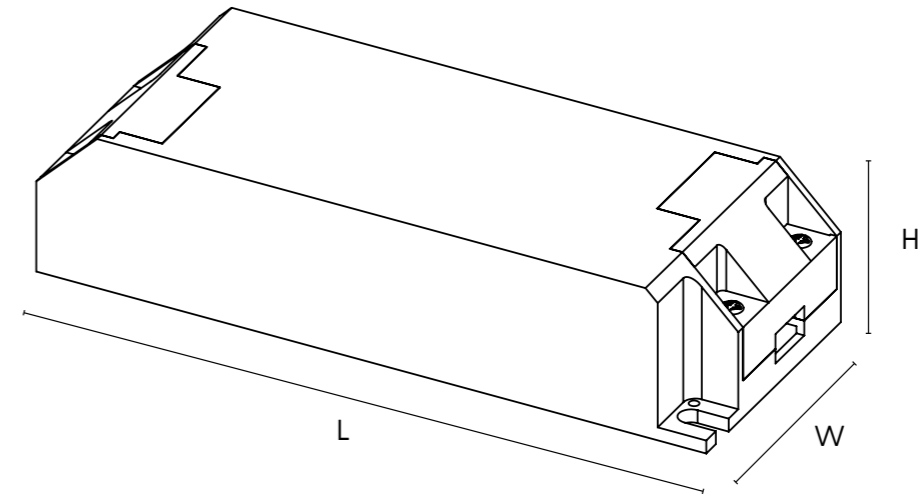

## ŞERİT LED LED STRIP

### Teknik Özellikler Technical Specifications

Şerit Led  
Led Strip

Çalışma Gerilimi : 12 V DC  
Operating Voltage Range : 12 V DC

IP Derecesi : IP20  
IP Rating : IP20

IK Derecesi : IK07  
IK Rating : IK07

Çalışma Sıcaklığı : -20 C / 45 C  
Operating Temp. Range : -20 C / 45 C

## NEON ŞERİT LED NEON LED STRIP

### Teknik Özellikler Technical Specifications

Neon Şerit Led  
Neon Led Strip

Çalışma Gerilimi : 220-240 V AC  
Operating Voltage Range : 220-240 V AC

IP Derecesi : IP65  
IP Rating : IP65

IK Derecesi : IK07  
IK Rating : IK07

Çalışma Sıcaklığı : -20 C / 45 C  
Operating Temp. Range : -20 C / 45 C



### ŞERİT LED

Geleneksel aydınlatma ürünlerine göre düşük güç kullanımı ve yüksek aydınlatma kalitesi, uzun ömürlü ve daha az ısı üretimi ile yüksek verimlilik. Mimari projelerden kişisel tercihlere kadar her türlü ahşap, metal, seramik, cam, duvar vb. yüzeylerde geniş bir kullanım yelpazesi sunar.

### NEON ŞERİT LED

Yumuşak, esnek ve ışık geçirgen dış materyal. İç ve dış aydınlatma için maksimum konfor ve ışık verimliliği sunar. Düşük enerji tüketimi ve çevre dostu yapısı ile estetik bir aydınlatma sağlar.

### LED STRIP

Compared to traditional lighting products, low power usage and high lighting quality, long life and high efficiency with less heat generation. All kinds of wood, metal, ceramic, glass, wall, etc., from architectural projects to personal preferences. It offers a wide range of uses on surfaces.

### NEON LED STRIP

Soft, flexible and transparent outer material. It offers maximum comfort and light efficiency for interior and exterior lighting. It provides aesthetic lighting with its low energy consumption and environmentally friendly structure.

## ŞERİT LED (4040) LED STRIP (4040)

Enerji Verimliliği Sınıfı Energy Efficiency Class	Ürün Kodu Product Code	Renk Color	Güç (W/Mt) Power	Gerilim (V) Voltage (V)	Işık Akısı (Lm/Mt) Luminous Flux	Çip Sayısı Number of Chips	Koli Miktarı (Mt) Box Amount	Fiyat Price
A T G	BL-SL-1001	3000 K	8	12V	900	60	250 Mt	\$1,15
A T G	BL-SL-1002	6500 K	8	12V	900	60	250 Mt	\$1,15
A T G	BL-SL-1003	Mavi	8	12V	120	60	250 Mt	\$1,15
A T G	BL-SL-1004	Yeşil	8	12V	120	60	250 Mt	\$1,15
A T G	BL-SL-1005	Amber	8	12V	120	60	250 Mt	\$1,15
A T G	BL-SL-1006	4000 K	8	12V	900	60	250 Mt	\$1,15

## NEON ŞERİT LED NEON LED STRIP

Enerji Verimliliği Sınıfı Energy Efficiency Class	Ürün Kodu Product Code	Renk Color	Işık Akısı (Lm/Mt) Luminous Flux	Giriş Voltajı Input Voltage	IP Derecesi IP Rating	Koli Miktarı (Mt) Box Amount	Fiyat Price
A T G	BL-NL-1001	3000 K	130	220-240 V AC	IP65	25 Mt	\$4,9
A T G	BL-NL-1002	4000 K	130	220-240 V AC	IP65	25 Mt	\$4,9
A T G	BL-NL-1003	6500 K	130	220-240 V AC	IP65	25 Mt	\$4,9
A T G	BL-NL-1004	KIRMIZI	10	220-240 V AC	IP65	25 Mt	\$4,9
A T G	BL-NL-1005	MAVİ	18	220-240 V AC	IP65	25 Mt	\$4,9
A T G	BL-NL-1006	YEŞİL	30	220-240 V AC	IP65	25 Mt	\$4,9
A T G	BL-NL-1007	AMBER	85	220-240 V AC	IP65	25 Mt	\$4,9



# NEON LED 12V

## NEON LED 12V

### Teknik Özellikler

#### Technical Specifications

Malzeme Tipi : PVC  
Material Type: PVC

Çalışma Gerilimi : DC 12 V  
Operating Voltage Range : DC 12 V

IP Derecesi : IP64  
IP Rating : IP64

Renksel Geri Verim : >70  
Color Rendering Index : >70

Çalışma Sıcaklığı : -20 C / 45 C  
Operating Temp. Range : -20 C / 45 C

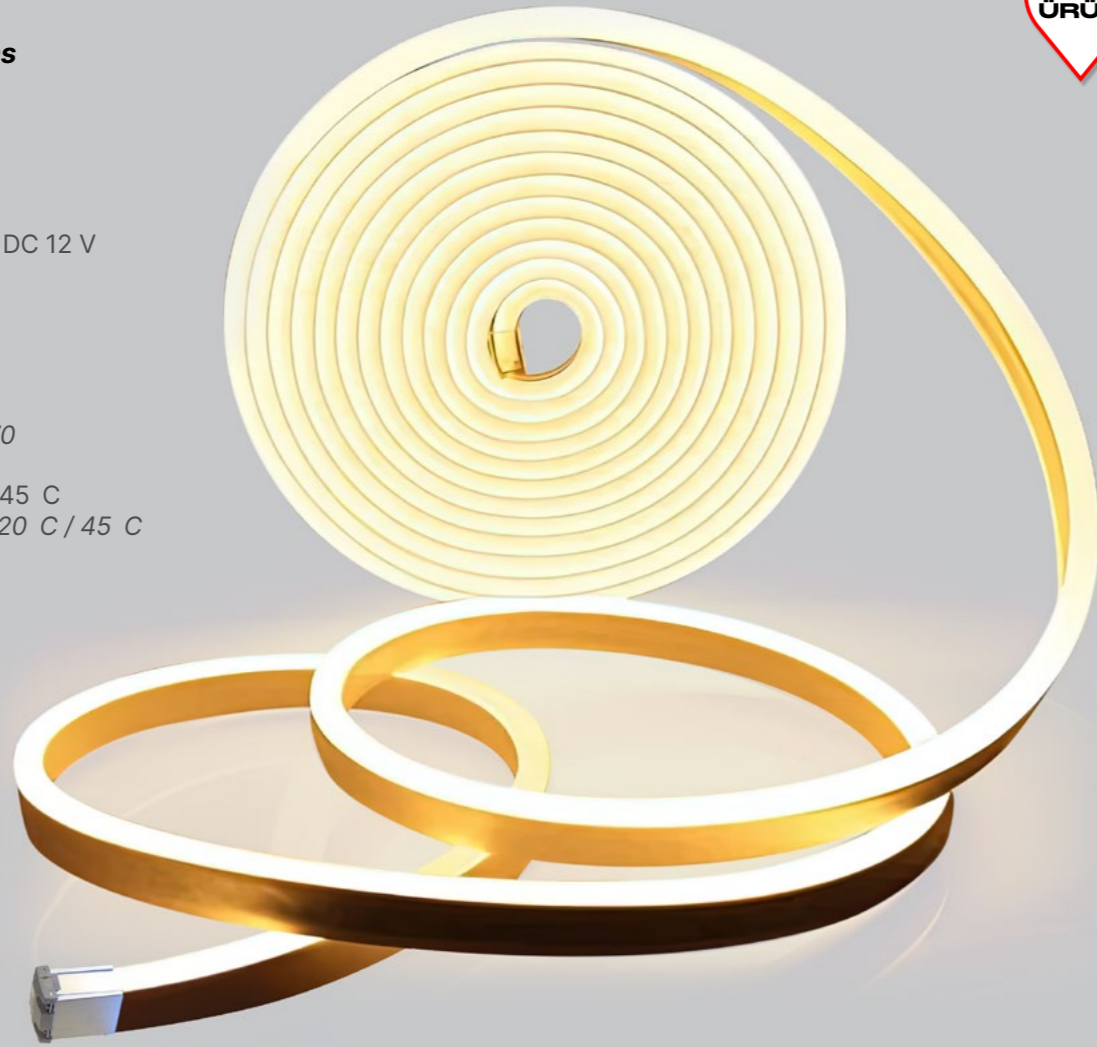

### NEON LED 12V

Yumuşak, esnek ve ışık geçirgen dış materyal. İç ve dış aydınlatma için maksimum konfor ve ışık verimliliği sunar. Düşük enerji tüketimi ve çevre dostu yapısı ile estetik bir aydınlatma sağlar.

### NEON LED 12V

Soft, flexible and transparent outer material. It offers maximum comfort and light efficiency for interior and exterior lighting. It provides aesthetic lighting with its low energy consumption and environmentally friendly structure.

# NEON LED 12V

## NEON LED 12V

Enerji Verimliliği Sınıfı Energy Efficiency Class	Ürün Kodu Product Code	Renk Color	Işık Akısı (Lm/Mt) Luminous Flux	Boyutlar (WxLxH) mm Dimensions	Kesim Aralığı Cutting Range	Koli Miktarı (Mt) Box Amount	Fiyat Price
A T G	BL-NL-0001	3000 K	200	6 x 12	2.5cm	25 Mt	\$3.95
A T G	BL-NL-0002	4000 K	200	6 x 12	2.5cm	25 Mt	\$3.95
A T G	BL-NL-0003	6500 K	200	6 x 12	2.5cm	25 Mt	\$3.95
A T G	BL-NL-0004	KIRMIZI	20	6 x 12	2.5cm	25 Mt	\$3.95
A T G	BL-NL-0005	MAVİ	60	6 x 12	2.5cm	25 Mt	\$3.95
A T G	BL-NL-0006	YEŞİL	36	6 x 12	2.5cm	25 Mt	\$3.95
A T G	BL-NL-0007	AMBER	170	6 x 12	2.5cm	25 Mt	\$3.95



# ŞERİT LED TRAFOLARI LED STRIP TRANSFORMERS

## Teknik Özellikler Technical Specifications

Gövde : Alüminyum  
Body : Aluminium

Gövde Renkleri : Metalik  
Body Colors : Metallic

Kapak : Alüminyum  
Cover : Aluminium

Kapak Rengi : Metalik  
Cover Color : Metallic

Çalışma Gerilimi : 220-240 V AC  
Operating Voltage Range : 220-240 V AC

IP Derecesi : IP20  
IP Rating : IP20

IK Derecesi : IK08  
IK Rating : IK08

Çalışma Sıcaklığı : -20 C / 45 C  
Operating Temp. Range : -20 C / 45 C



## ŞERİT LED TRAFOLARI

Neon ve şerit ledlere bağlanan çalışma mekanizmasına led trafo denir. Güvenilir ve verimli bir aydınlatma sistemi için doğru elektriksel kapasiteler ve işlevsel özellikler sağlanması önemlidir.

## LED STRIP TRANSFORMERS

The operating mechanism connected to neon and strip LED's is called a led transformer. Providing the correct electrical capacities and functional properties is essential for a reliable and efficient lighting system.

# ŞERİT LED TRAFOLARI LED STRIP TRANSFORMERS

TURQUALITY®

Ürün Kodu Product Code	Güç Power	Gerilim (V) Voltage (V)	Akım (A) Current (A)	Boyutlar (WxLxH) mm Dimensions	Gövde Malzemesi Body Material	Koli Adeti Quantity in Carton	Fiyat Price
BL-T1-132-1599	60W	12V	5A	40 × 160 × 32	Alüminyum	50	\$12,00
BL-T1-132-1600	120W	12V	10A	46 × 190 × 37	Alüminyum	40	\$15,70
BL-T1-132-1601	150W	12V	12,5A	58 × 200 × 40	Alüminyum	40	\$21,30
BL-T1-132-1602	200W	12V	16,5A	58 × 200 × 40	Alüminyum	40	\$25,90
BL-T1-132-1603	250W	12V	20A	68 × 225 × 40	Alüminyum	32	\$28,70
BL-T1-132-1604	360W	12V	30A	68 × 225 × 42	Alüminyum	32	\$34,80

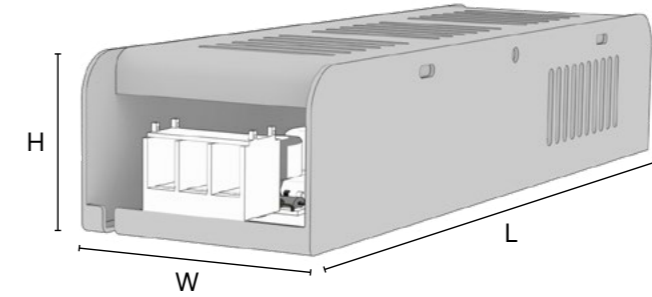

## SLIM LED TRAFOSU SLIM LED TRANSFORMER

### Teknik Özellikler Technical Specifications

Gövde : Alüminyum  
Body : Aluminium

Kapak : Alüminyum  
Cover : Aluminium

IP Derecesi : IP20  
IP Rating : IP20

PF : >0.5  
PF : >0.5

Çalışma Gerilimi : 185-265V AC  
Operating Voltage : 185-265V AC

Çalışma Sıcaklığı : -20 C / 45 C  
Operating Temp. Range : -20 C / 45 C



#### SLIM LED TRAFOSU

Led aydınlatmalarınız için güç kaynağı olarak kullanabileceğiniz bu trafo yüksek performans ve güvenilirlik sağlar. Yüksek kaliteli malzemeler kullanılarak üretilmiş, düşük güç tüketimi ile enerji tasarrufu sağlayan bir aydınlatma ürünüdür.

#### SLIM LED TRANSFORMER

This transformer can be used as a power supply for your led lighting and provides high performance and reliability. It is a lighting product that is manufactured using high quality materials and saves energy with low power consumption.

## SLIM LED TRAFOSU SLIM LED TRANSFORMER

Ürün Kodu Product Code	Güç Power	Gerilim (V) Voltage (V)	Giriş Voltajı Input Voltage	Boyutlar (WxLxH) mm Dimensions	Gövde Malzemesi Body Material	Koli Adeti Quantity in Carton	Fiyat Price
132-2100	60W	12V	185-265V	113 x 50 x 22	Alüminyum	50	\$8,3
132-2101	120W	12V	185-265V	138 x 50 x 22	Alüminyum	50	\$10,50
132-2102	150W	12V	185-265V	178 x 50 x 22	Alüminyum	40	\$13,60
132-2103	200W	12V	185-265V	178 x 50 x 22	Alüminyum	30	\$14,50
132-2104	250W	12V	185-265V	205 x 50 x 22	Alüminyum	30	\$16,40
132-2105	360W	12V	185-265V	238 x 50 x 22	Alüminyum	25	\$20,10



# AVİZE KUMANDASI

## CHANDELIER REMOTE CONTROL

### Teknik Özellikler

#### Technical Specifications

Gövde : Plastik  
Body : Plastic

Gövde Renkleri : Beyaz  
Body Colors : White

Çalışma Gerilimi : 220-240 V AC  
Operating Voltage Range : 220-240 V AC

Çalışma mesafesi : 30m  
Working distance : 30m

Akkor lamba : <1000W  
Incandescent lamp : <1000W

Enerji tasarruflu lamba : /LED <300W  
Energy-saving lamp : /LED <300W

Çalışma voltajı : 12V (23A pil)  
Working voltage : 12V (23A battery)

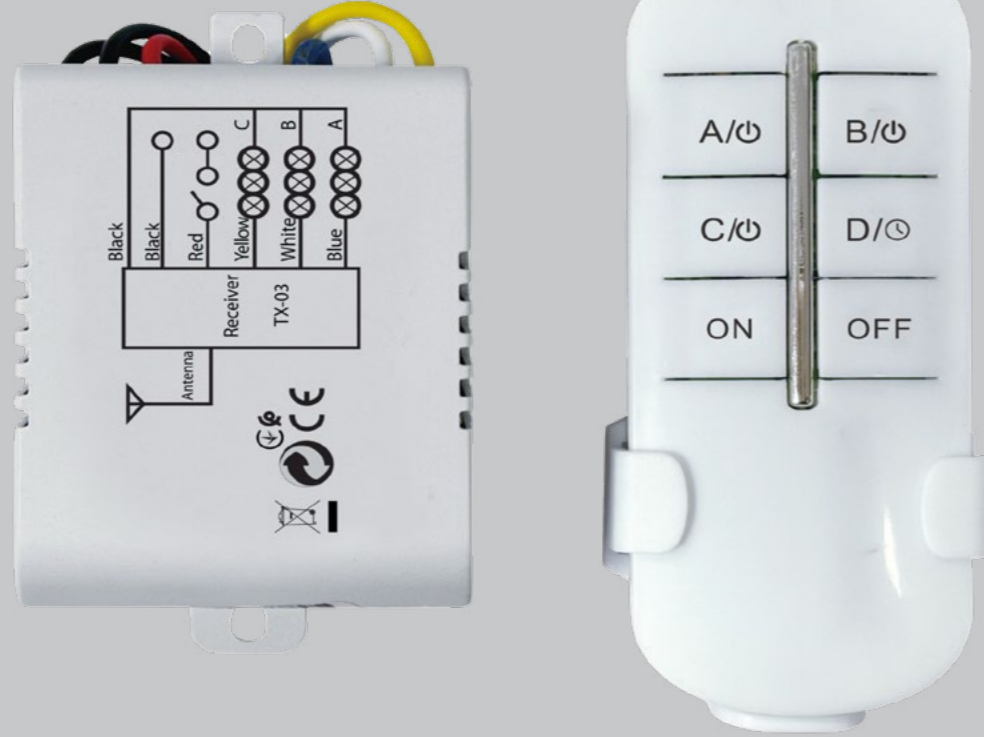

### AVİZE KUMANDASI

Avizeler gibi katmanlı aydınlatma ürünlerinde ışık kontrolü sağlamak için kullanılır. 15-20 metre menzile sahiptir ve kullanıcıya uzaktan kontrol imkanı sunar. Kullanışlı tasarımı sağlam, rahat ve konforlu bir kullanım sunar.

### CHANDELIER REMOTE CONTROL

It is used to provide light control in layered lighting products such as chandeliers. It has a range of 15-20 meters and offers remote control to the user. The handy design offers a robust, convenient and comfortable use.

### AVİZE KUMANDASI

#### CHANDELIER REMOTE CONTROL

Ürün Kodu Product Code	Ürün Adı Product Name	Güç Power	Boyutlar (WxLxH) mm Dimensions	Gövde Malzemesi Body Material	Çalışma Mesafesi Operating Distance	Koli Adeti Quantity in Carton	Fiyat Price
BL-AK-0001	Avize İçin 2 Yollu IR	300W	74×51×24	Plastik	30m	50	\$14,80
BL-AK-0002	Avize İçin 3 Yollu IR	300W	74×51×24	Plastik	30m	50	\$16,10
BL-AK-0003	Avize İçin 4 Yollu IR	300W	74×51×24	Plastik	30m	50	\$17,30
BL-AK-0004	Avize İçin 6 Yollu IR	300W	74×51×24	Plastik	30m	50	\$26,60

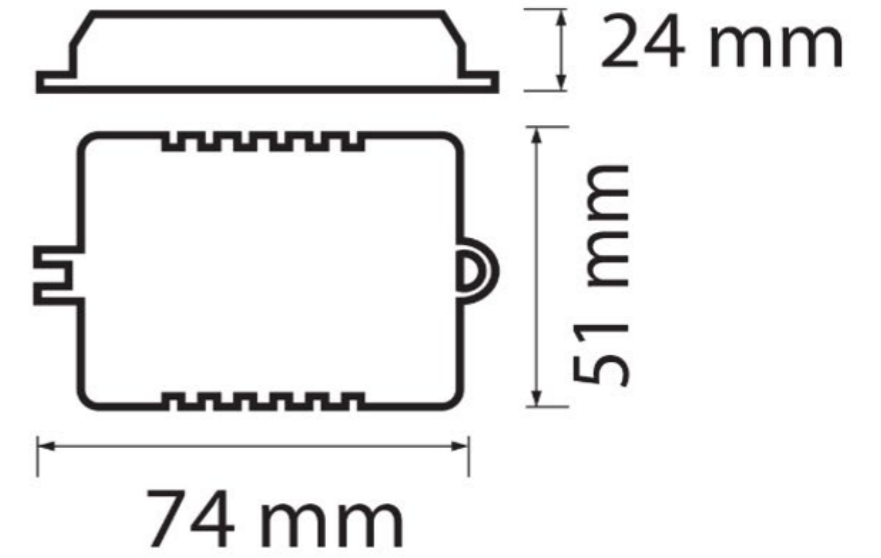
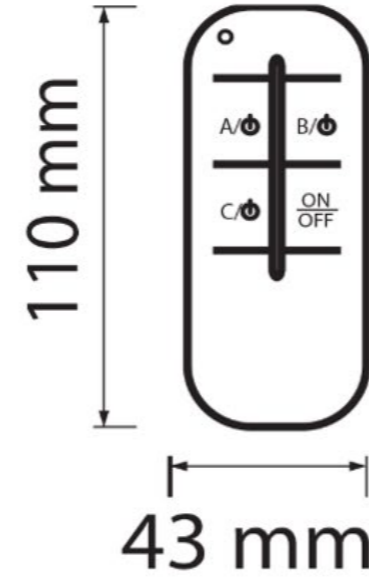



## AKSESUARLAR ACCESSORIES



GU10 DUY  
GU10



ASKI TAKIMI PLASTİK  
HANGER SET PLASTIC



E27 PORSELEN DUY  
E27 PORCELAIN



MONOFAZE ERKEK FİŞ  
SINGLE PHASE MALE PLUG



TOPRAKLI ERKEK FİŞ  
EARTHED MALE PLUG



TOPRAKLI DİŞİ FİŞ  
EARTHED FEMALE PLUG



ASKI TAKIMI SERAMİK  
HANGER SET CERAMIC



L TİPİ TOPRAKLI ERKEK FİŞ  
L TYPE EARTHED MALE PLUG



## AKSESUARLAR ACCESSORIES

### GU10 DUY GU10

Ürün Kodu Product Code	Ürün Adı Product Name	Koli Adedi Quantity in Carton	Fiyat Price
BR-GU-0001	Gu10 Duy	100	\$0,5

### E27 PORSELEN DUY E27 PORCELAIN

Ürün Kodu Product Code	Ürün Adı Product Name	Koli Adedi Quantity in Carton	Fiyat Price
132-1535	E27 Porselen Duy	400	\$0,4

### ASKI TAKIMI SERAMİK HANGER SET CERAMIC

Ürün Kodu Product Code	Ürün Adı Product Name	Koli Adedi Quantity in Carton	Fiyat Price
BR-001411	Askı Takımı (E27 Seramik Duy)	100	38 TL

### ASKI TAKIMI PLASTİK HANGER SET PLASTIC

Ürün Kodu Product Code	Ürün Adı Product Name	Koli Adedi Quantity in Carton	Fiyat Price
BR-001412	Askı Takımı (E27 Plastik Duy)	100	35,70 TL

### AKSESUARLAR ACCESSORIES

Ürün Kodu Product Code	Ürün Adı Product Name	Kutu Adedi Quantity in box	Koli Adedi Quantity in Carton	Fiyat Price
BR-1510	Monofaze Erkek Fiş Single Phase Male Plug	50	900	89,10 TL
BR-1511	Topraklı Erkek Fiş Earthed Male Plug	50	600	114,80 TL
BR-1515	Topraklı Dişi Fiş Earthed Female Plug	40	480	125,10 TL
BR-1516	L Tipi Topraklı Erkek Fiş L Type Earthed Male Plug	50	600	91,60 TL

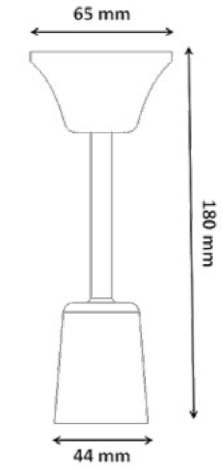

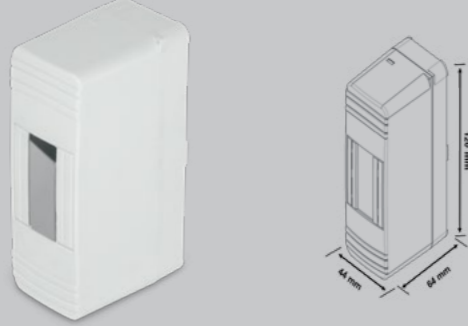

2'li Mühürlü Sigorta Kutusu  
2 Module Distribution Box - Sealed

Ürün Kodu Product Code	Kutu Adedi Quantity in Box	Koli Adedi Quantity in Carton	Fiyat Price
BR-818	1	98	38,80 TL



4'li Mühürlü Sigorta Kutusu  
4 Module Distribution Box - Sealed

Ürün Kodu Product Code	Kutu Adedi Quantity in Box	Koli Adedi Quantity in Carton	Fiyat Price
BR-819	1	50	63,90 TL

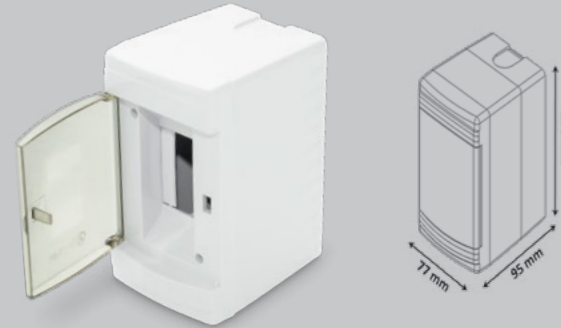

2'li Siva Üstü Sigorta Kutusu  
2 Module Distribution Box - Surface Mounted

Ürün Kodu Product Code	Kutu Adedi Quantity in Box	Koli Adedi Quantity in Carton	Fiyat Price
BR-820	2	40	126,80 TL

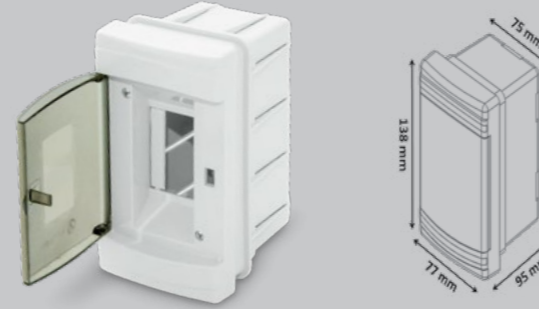

2'li Siva Altı Sigorta Kutusu  
2 Module Distribution Box - Recessed

Ürün Kodu Product Code	Kutu Adedi Quantity in Box	Koli Adedi Quantity in Carton	Fiyat Price
BR-821	2	40	115,20 TL

SIVA ALTI VE SIVA ÜSTÜ SİGORTA KUTULARI  
Standartlara uygun olarak üretilen siva altı ve siva üstü sigorta kutularını ısıya ve darbelere dayanıklı gövdesi, geniş iç hacmi ve şeffaf yaylı kapak özellikleri ile evinizde ve iş yerinizde güvenle kullanabilirsiniz.

RECESSED AND SURFACE MOUNTED FUSE BOXES  
You can safely use flush-mounted and surface-mounted fuse boxes produced in accordance with the standards in your home and workplace with their heat and impact resistant body, large internal volume and transparent spring cover features.



6'lı Siva Üstü Sigorta Kutusu  
6 Module Distribution Box - Surface Mounted

Ürün Kodu Product Code	Kutu Adedi Quantity in Box	Koli Adedi Quantity in Carton	Fiyat Price
BR-804	1	30	220,20 TL



6'lı Siva Altı Sigorta Kutusu  
6 Module Distribution Box - Recessed

Ürün Kodu Product Code	Kutu Adedi Quantity in Box	Koli Adedi Quantity in Carton	Fiyat Price
BR-803	1	30	187,50 TL



9'lu Siva Üstü Sigorta Kutusu  
9 Module Distribution Box - Surface Mounted

Ürün Kodu Product Code	Kutu Adedi Quantity in Box	Koli Adedi Quantity in Carton	Fiyat Price
BR-806	1	20	286,10 TL



9'lu Siva Altı Sigorta Kutusu  
9 Module Distribution Box - Recessed

Ürün Kodu Product Code	Kutu Adedi Quantity in Box	Koli Adedi Quantity in Carton	Fiyat Price
BR-805	1	20	246,20 TL



12'li Siva Üstü Sigorta Kutusu  
12 Module Distribution Box - Surface Mounted

Ürün Kodu Product Code	Kutu Adedi Quantity in Box	Koli Adedi Quantity in Carton	Fiyat Price
BR-808	1	20	377,30 TL



12'li Siva Altı Sigorta Kutusu  
12 Module Distribution Box - Recessed

Ürün Kodu Product Code	Kutu Adedi Quantity in Box	Koli Adedi Quantity in Carton	Fiyat Price
BR-807	1	20	332,20 TL



## SIVA ALTI VE SIVA ÜSTÜ SİGORTA KUTULARI RECESSED AND SURFACE MOUNTED FUSE BOXES

## SIVA ALTI VE SIVA ÜSTÜ SİGORTA KUTULARI RECESSED AND SURFACE MOUNTED FUSE BOXES

TURQUALITY®



**16'li Siva Üstü Sigorta Kutusu**  
16 Module Distribution Box - Surface Mounted

Ürün Kodu Product Code	Kutu Adedi Quantity in Box	Koli Adedi Quantity in Carton	Fiyat Price
BR-816	1	10	506,20 TL



**16'li Siva Altı Sigorta Kutusu**  
16 Module Distribution Box - Recessed

Ürün Kodu Product Code	Kutu Adedi Quantity in Box	Koli Adedi Quantity in Carton	Fiyat Price
BR-815	1	10	468,10 TL

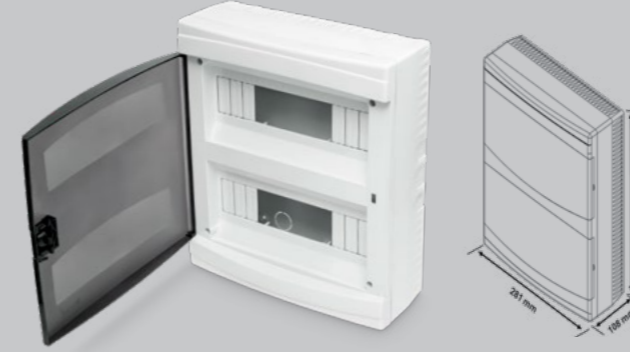

**24'ü Siva Üstü Sigorta Kutusu**  
24 Module Distribution Box - Surface Mounted

Ürün Kodu Product Code	Kutu Adedi Quantity in Box	Koli Adedi Quantity in Carton	Fiyat Price
BR-810	1	10	578 TL



**24'ü Siva Altı Sigorta Kutusu**  
24 Module Distribution Box - Recessed

Ürün Kodu Product Code	Kutu Adedi Quantity in Box	Koli Adedi Quantity in Carton	Fiyat Price
BR-809	1	10	517,10 TL



**18'li Siva Üstü Sigorta Kutusu**  
18 Module Distribution Box - Surface Mounted

Ürün Kodu Product Code	Kutu Adedi Quantity in Box	Koli Adedi Quantity in Carton	Fiyat Price
BR-814	1	10	540,70 TL



**18'li Siva Altı Sigorta Kutusu**  
18 Module Distribution Box - Recessed

Ürün Kodu Product Code	Kutu Adedi Quantity in Box	Koli Adedi Quantity in Carton	Fiyat Price
BR-813	1	10	491,80 TL



**36'li Siva Üstü Sigorta Kutusu**  
36 Module Distribution Box - Surface Mounted

Ürün Kodu Product Code	Kutu Adedi Quantity in Box	Koli Adedi Quantity in Carton	Fiyat Price
BR-812	1	5	815 TL



**36'li Siva Altı Sigorta Kutusu**  
36 Module Distribution Box - Recessed

Ürün Kodu Product Code	Kutu Adedi Quantity in Box	Koli Adedi Quantity in Carton	Fiyat Price
BR-811	1	5	752,50 TL

### SIVA ALTI VE SIVA ÜSTÜ SİGORTA KUTULARI

Standartlara uygun olarak üretilen siva altı ve siva üstü sigorta kutularını ısıya ve darbelere dayanıklı gövdesi, geniş iç hacmi ve şeffaf yaylı kapak özellikleri ile evinizde ve iş yerinizde güvenle kullanabilirsiniz.

### RECESSED AND SURFACE MOUNTED FUSE BOXES

You can safely use flush-mounted and surface-mounted fuse boxes produced in accordance with the standards in your home and workplace with their heat and impact resistant body, large internal volume and transparent spring cover features.



180



181

www.borled.com.tr

## SIVA ALTI SAC TABANLI SİGORTA KUTUSU (PLASTİK KAPAKLI) FUSE BOX WITH SHEET BASED (PLASTIC COVER)

### Teknik Özellikler Technical Specifications

Gövde : DKP  
Body : DKP

Gövde Renkleri : Gri  
Body Colors : Grey

Kapak : ABS  
Cover : ABS

Kapak Rengi : Beyaz  
Cover Color : White

Cam : S.A.N  
Glass : S.A.N

IP Derecesi : IP20  
IP Rating : IP20

IK Derecesi : IK06  
IK Rating : IK06



## SIVA ALTI SAC TABANLI SİGORTA KUTUSU (PLASTİK KAPAKLI) FUSE BOX WITH SHEET BASED (PLASTIC COVER)

Ürün Kodu Product Code	Ürün Adı Product Name	Boyutlar (WxLxH) mm Dimensions	Kutu Adedi Quantity in Box	Koli Adedi Quantity in Carton	Fiyat Price
BR-850	16'lı Sıva Altı Sigorta Kutusu 16 Module Distribution Box - Recessed	116 × 365 × 225	1	10	\$32,70
BR-851	24'lü Sıva Altı Sigorta Kutusu 24 Module Distribution Box - Recessed	105 × 281 × 325	1	10	\$34,20

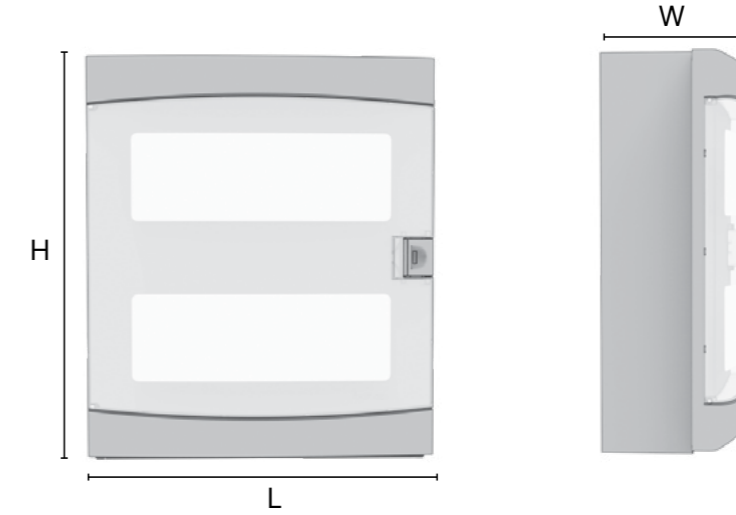

## SIVA ALTI SAC TABANLI ZAYIF AKIM KUTULARI WEAK CURRENT BOXES WITH FLUSH SHEET BASED

### Teknik Özellikler Technical Specifications

Gövde : DKP  
Body : DKP

Gövde Renkleri : Gri  
Body Colors : Grey

Kapak : DKP  
Cover : DKP

Kapak Rengi : Gri  
Cover Color : Grey

IK Derecesi : IK08  
IK Rating : IK08



## SIVA ALTI SAC TABANLI ZAYIF AKIM KUTULARI WEAK CURRENT BOXES WITH FLUSH SHEET BASED

Ürün Kodu Product Code	Ürün Adı Product Name	Boyutlar (WxLxH) mm Dimensions	Koli Adedi Quantity in Carton	Fiyat Price
BR-860	24'lü Sıva Altı Sac Zayıf Akım Kutusu 24 Flush Mounted Sheet Weak Current Box	115 × 315 × 515	1	\$127,50

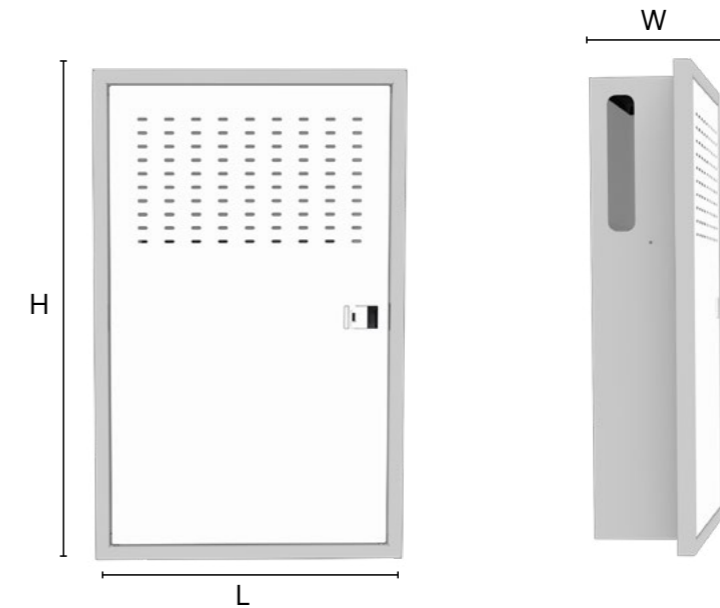

## TERMOPLASTİK BUATLAR THERMOPLASTIC CONJECTIONS



Ürün Kodu Product Code	Boyutlar (WxLxH) mm Dimensions	Koli Adedi Quantity in Carton	Fiyat Price
BR-750	70x80x40	50	54,60 TL
BR-760	85x85x40	50	59,80 TL
BR-770	110x110x55	20	90,40 TL

## LÜKS KARE BUATLAR LUXURIOUS SQUARE CONJECTIONS



Ürün Kodu Product Code	Boyutlar (WxLxH) mm Dimensions	Koli Adedi Quantity in Carton	Fiyat Price
BR-730	80x80x40	140	22,70 TL
BR-731	100x100x45	140	32,50 TL
BR-732	130x130x55	180	49,80 TL
BR-734	150x150x58	108	68,30 TL
BR-733	200x200x70	60	119 TL

## BUATLAR JUNCTION BOXES



Ürün Kodu Product Code	Ürün Adı Product Name	Koli Adedi Quantity in Carton	Fiyat Price
BR-1713	Alçıpan Buat	100	20,80 TL
BR-710	Lüks Buat Kapağı	100	6 TL

## GEÇMELİ ve ALÇIPAN KASA (KAPAKSIZ) INTERLACED AND DRYWALL CASE (WITHOUT COVER)



Ürün Kodu Product Code	Ürün Adı Product Name	Renk Color	Koli Adedi Quantity in Carton	Fiyat Price
BR-1413	Geçmeli Kasa Büyük	Turuncu	100	7,80 TL
BR-1712	Alçıpan Kasa	Turuncu	200	15,80 TL
BR-1413-E	Geçmeli Kasa Büyük	Siyah	100	6,50 TL
BR-1712-E	Alçıpan Kasa	Siyah	200	15,20 TL



# ÇERÇEVELER FRAMES

## Teknik Özellikler Technical Specifications

Gövde : DKP Sac  
Body : DKP Metal Sheet

Gövde Renkleri : Beyaz  
Body Color : White



30X30 KARE SLIM LED CLIP-IN ÇERÇEVE  
30X30 SQUARE SLIM LED CLIP-IN FRAME

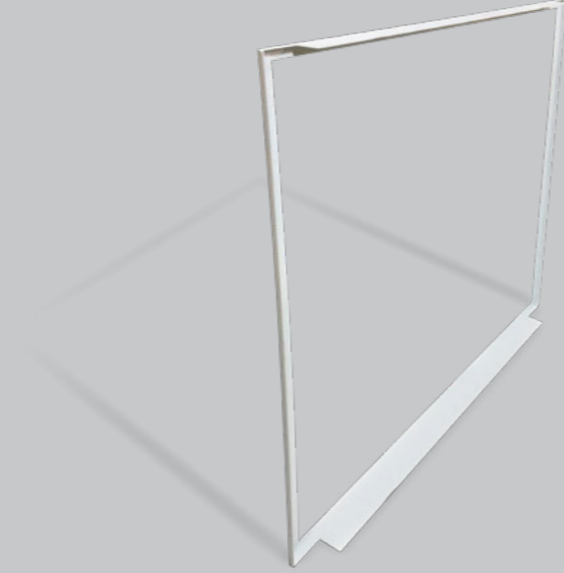

60X60 KARE SLIM PANEL CLIP-IN ÇERÇEVE  
60X60 SQUARE SLIM PANEL CLIP-IN FRAME



KARE SLIM PANEL SIVA ÜSTÜ ÇERÇEVE  
SQUARE SLIM PANEL SURFACE MOUNTED FRAME



## 30X30 KARE SLIM LED CLIP-IN ÇERÇEVE 30X30 SQUARE SLIM LED CLIP-IN FRAME

Ürün Kodu Product Code	Ürün Adı Product Name	Koli Adedi Quantity in Carton	Fiyat Price
134-0922	Diş Çerçeve 30x30 Led Slim Kare Clip-In Kasa	24	103,50 TL

## 60X60 KARE SLIM PANEL CLIP-IN ÇERÇEVE 60X60 SQUARE SLIM PANEL CLIP-IN FRAME

Ürün Kodu Product Code	Ürün Adı Product Name	Koli Adedi Quantity in Carton	Fiyat Price
134-1005	Diş Çerçeve 60x60 Led Slim Kare Clip-In Kasa	6	191,40 TL

## KARE SLIM PANEL SIVA ÜSTÜ ÇERÇEVE SQUARE SLIM PANEL SURFACE MOUNTED FRAME

Ürün Kodu Product Code	Ürün Adı Product Name	Koli Adedi Quantity in Carton	Fiyat Price
134-0995	LED 30X30 SIVA ÜSTÜ DEMONTE KASA	24	149,10 TL
134-0983	LED 30X60 SIVA ÜSTÜ DEMONTE KASA	12	235,70 TL
134-0963	LED 60X60 SIVA ÜSTÜ DEMONTE KASA	6	323,70 TL
134-0984	LED 30X120 SIVA ÜSTÜ DEMONTE KASA	6	602,90 TL



# SIKMALI KABLO PABUCU/KONEKTÖRÜ CABLE CONNECTOR STANDARD SERIES

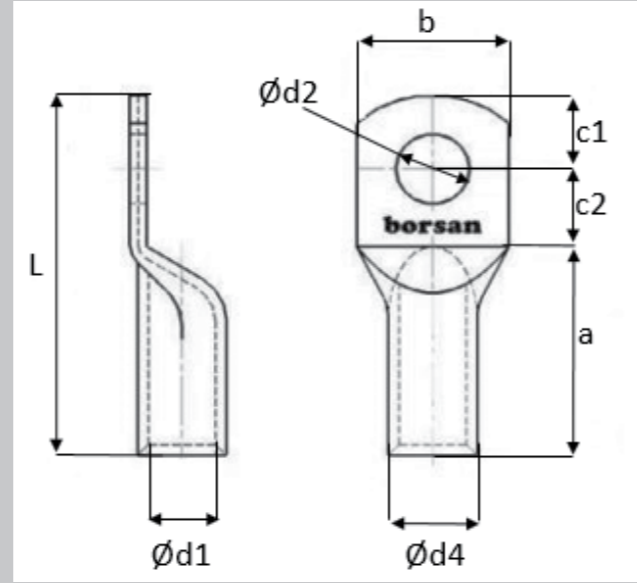

Teknik veri / Datasheet

## SIKMALI KABLO PABUCU/KONEKTÖRÜ

Kablo papucu/konektörü, kablo uçlarına takılarak kabloyu diğer elektriksel elemanların terminal uçlarına bağlamaya yarayan işlevsel bir aksesuardır. Konektörler iki ayrı ekipmanı birbirine bağladığı gibi bakım, onarım ve demontaj işlemlerinde operatörlere kolaylık sağlar.

## CABLE CONNECTOR STANDARD SERIES

The cable connector is a functional accessory that attaches to the cable ends and connects the cable to the terminal end of other electrical elements. Connectors connect two separate equipment and provide convenience to operators in maintenance, repair and disassembly processes.

## SIKMALI KABLO PABUCU CABLE LUGS STANDARD SERIES

Ürün Kodu Product Code	Kesit Section	d1	Metrik(d2) Metric(d2)	d4	Et Kalınlık Thickness	a	b	c1	c2	L	Kutu Adet Box Pcs.	Fiyat Price
BR-1780 M5	6	4,50	5,00	5,80	0,65	13,40	8,40	5,00	6,50	24,9	1500	Fiyat Sorunuz
BR-1780-M5K	6	4,50	5,00	5,80	0,65	13,40	8,40	5,00	6,50	24,9	750	Fiyat Sorunuz
BR-1781 M5	10	4,90	5,00	6,20	0,65	13,90	10,30	6,60	7,30	27,8	1100	Fiyat Sorunuz
BR-1781-M5K	10	4,90	5,00	6,20	0,65	13,90	10,30	6,60	7,30	27,8	550	Fiyat Sorunuz
BR-1782 M6	16	6,60	6,00	7,90	0,65	17,15	11,70	6,40	7,60	31,15	650	Fiyat Sorunuz
BR-1782-M6K	16	6,60	6,00	7,90	0,65	17,15	11,70	6,40	7,60	31,15	325	Fiyat Sorunuz
BR-1782-M8	16	6,60	8,00	7,90	0,65	17,15	11,70	6,40	7,60	31,15	650	Fiyat Sorunuz
BR-1782-M8K	16	6,60	8,00	7,90	0,65	17,15	11,70	6,40	7,60	31,15	325	Fiyat Sorunuz
BR-1783 M8	25	7,50	8,00	9,00	0,75	22,50	13,25	8,20	7,90	38,6	420	Fiyat Sorunuz
BR-1783-M8K	25	7,50	8,00	9,00	0,75	22,50	13,25	8,20	7,90	38,6	210	Fiyat Sorunuz
BR-1784 M8	35	8,70	8,00	10,80	1,05	24,85	15,50	9,20	10,35	44,4	250	Fiyat Sorunuz
BR-1784-M8K	35	8,70	8,00	10,80	1,05	24,85	15,50	9,20	10,35	44,4	125	Fiyat Sorunuz
BR-1794 M10	35	8,70	10,00	10,80	1,05	24,85	15,50	9,20	10,35	44,4	250	Fiyat Sorunuz
BR-1794 M10K	35	8,70	10,00	10,80	1,05	24,85	15,50	9,20	10,35	44,4	125	Fiyat Sorunuz
BR-1785 M10	50	10,30	10,00	12,60	1,15	28,90	18,20	11,50	11,15	51,55	170	Fiyat Sorunuz
BR-1785-M10K	50	10,30	10,00	12,60	1,15	28,90	18,20	11,50	11,15	51,55	85	Fiyat Sorunuz
BR-1785 M12	50	10,30	12,00	12,60	1,15	28,90	18,20	11,50	11,15	51,55	170	Fiyat Sorunuz
BR-1785 M12K	50	10,30	12,00	12,60	1,15	28,90	18,20	11,50	11,15	51,55	85	Fiyat Sorunuz
BR-1786 M10	70	11,70	10,00	14,50	1,40	33,90	21,00	10,10	11,10	55,1	110	Fiyat Sorunuz
BR-1786 M12	70	11,70	12,00	14,50	1,40	33,90	21,00	10,10	11,10	55,1	110	Fiyat Sorunuz
BR-1787 M8	95	13,80	8,00	16,50	1,35	36,70	24,20	10,55	12,05	59,3	90	Fiyat Sorunuz
BR-1787 M10	95	13,80	10,00	16,50	1,35	36,70	24,20	10,55	12,05	59,3	90	Fiyat Sorunuz
BR-1787 M12	95	13,80	12,00	16,50	1,35	36,70	24,20	10,55	12,05	59,3	90	Fiyat Sorunuz
BR-1787 M14	95	13,80	14,00	16,50	1,35	36,70	24,20	10,55	12,05	59,3	90	Fiyat Sorunuz
BR-1788 M10	120	15,90	10,00	19,10	1,60	42,55	28,20	13,90	13,60	70,05	65	Fiyat Sorunuz
BR-1788 M12	120	15,90	12,00	19,10	1,60	42,55	28,20	13,90	13,60	70,05	65	Fiyat Sorunuz
BR-1788 M14	120	15,90	14,00	19,10	1,60	42,55	28,20	13,90	13,60	70,05	65	Fiyat Sorunuz
BR-1789 M10	150	17,30	10,00	20,60	1,65	42,20	29,95	16,70	16,80	75,7	55	Fiyat Sorunuz
BR-1789 M12	150	17,30	12,00	20,60	1,65	42,20	29,95	16,70	16,80	75,7	55	Fiyat Sorunuz
BR-1789 M16	150	17,30	16,00	20,60	1,65	42,20	29,95	16,70	16,80	75,7	55	Fiyat Sorunuz
BR-1790 M12	185	19,05	12,00	22,60	1,78	46,60	33,25	17,35	18,95	82,9	35	Fiyat Sorunuz
BR-1790 M16	185	19,05	16,00	22,60	1,78	46,60	33,25	17,35	18,95	82,9	35	Fiyat Sorunuz
BR-1791 M16	240	21,55	16,00	25,20	1,83	54,30	37,25	17,35	17,95	89,6	25	Fiyat Sorunuz
BR-1792 M16	300	24,30	16,00	29,00	2,35	53,50	43,00	22,00	24,50	100	20	Fiyat Sorunuz
BR-1792 M20	300	24,30	20,00	29,00	2,35	53,50	43,00	22,00	24,50	100	20	Fiyat Sorunuz
BR-1793 M20	400	27,35	20,00	32,80	2,73	57,50	48,50	24,80	22,20	104,5	14	Fiyat Sorunuz

## Aydınlatmada Kullanılan Lambalar

Günümüzde aydınlatmada kullanılan lambalar aşağıdaki gibidir. Önceki yıllarda yapılmış olan aydınlatma sistemleri civa buharlı lambalar yoğun olarak kullanılmaktadır. Günümüzde ise Tedaş'ın şartnamelerinde Civa buharlı lamba kullanımı yasaklanmıştır. Aşağıdaki tabloda görüldüğü üzere teknoloji sürekli olarak gelişmekte daha yüksek ışık etkinliğine sahip ve daha uzun ömürlü ürünler seçilmektedir.

Lamba Türü	Işık Etkinliği (Lm/W)	Ömür (Saat)
Akkor lamba (Enkandesen)	8 - 16	1000
Halojen lamba (Tungsten)	12 - 26	2.000 - 4.000
Floresan lamba	45 - 100	6.000 - 15.000
Yb Civa Buharlı lamba	36 - 60	6.000 - 8.000
Metal Halide lamba	71 - 98	5.600 - 6.500
Endüksiyon	68 - 72	5.800 - 6.200
YB Sodyum Buharlı lamba	66 - 142	10.000 - 15.000
AB Sodyum Buharlı lamba	100 - 198	11.500 - 20.000
LED	80 - 165	50.000 - 100.000

## Işık Akısı (LM)

Bir ışık kaynağından ışılan akının göze etkiyen kısmına ışık akısı denir. Birimi lümen'dir ve ışının parlaklık duygusu uyandırma yeteneğini temsil eder. Toplam ışık akısı ise bir kaynaktan çıkan ve uzayın muhtelif kısımlarına yayılan ışık akılarının toplamı olarak tanımlanır. Işık enerjisinin ölçüsüdür. Diğer bir deyişle, bir ışık kaynağından toplam çıkış lümenle ifade edilir. Lümen ne kadar yüksek ışık ise o kadar parlak gözükür. (1 lümen = 0.00146 W)

## Aydınlık Düzeyi (Lux)

Birim yüzeye düşen toplam ışık akısı o yüzeyin aydınlık düzeyi olarak tanımlanır ve E ile gösterilir. Birimi lux'tür. Bir Lux'ün ışımaya gücü bir mum ışığına eş değerdir.

Renk Sıcaklığı  
(Color Temperature K)

Beyaz ışınım yapan bir ışık kaynağının sahip olduğu ışığın rengini ifade eder. Genelde eski tip enkandesen ampuller 2500K ışık rengine sahiptir. Bunun dışında 2700K sarı ışık, 3000K gün ışığı (veya sıcak beyaz), 4000K nötr beyaz, 5000-6500K soğuk beyaz ışık rengi olarak tabir edilir.

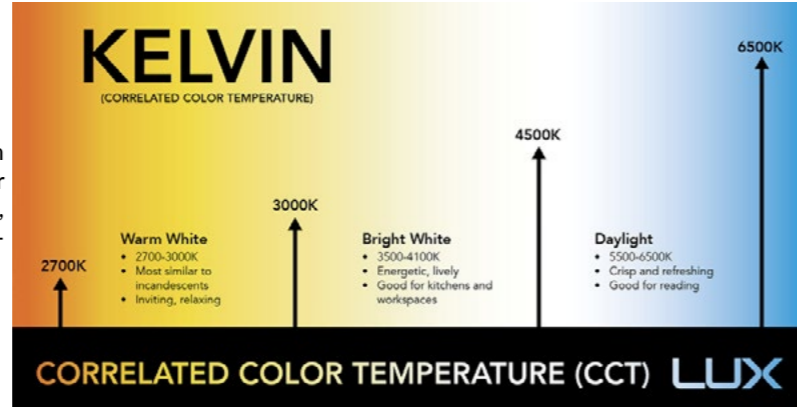

## Renksel Geri Verim (CRI)

Renksel Geri Verim nesnenin belli bir ışık kaynağı altında renk kalitesini ifade eder. Yüksek CRI değerine sahip bir ışık kaynağı, renklerin daha doğal görünmesini ifade eder. Değer, 0 (çok zayıf renk sunumu) ile 100 (mükemmel renk sunumu) arasında değişmektedir. Genel olarak 80 CRI olan ışık kaynakları uygun olarak kabul edilir.



## Işık Şiddeti (Cd)

Noktasal bir ışık kaynağının herhangi bir doğrultusundaki ışık şiddeti bu doğrultuyu içine alan uzay açısından çıkan ışık akısının uzay açısına bölümü olarak tanımlanır. Birimi Candela'dır ve 'cd' ile gösterilir. 1 Lümenlik ışık akısının 1 steradyanlık uzay açısından çıkması durumunda ışık şiddeti 1 cd olur.

## Işık

Dalga teorisine göre ışık elektromanyetik ışınlanma (radyasyon) enerjisinin gözle görülebilen bir şeklidir. Belli bir yayılma hızına frekansa ve dalga boyuna sahiptir. İnsanoğlu bu elektromanyetik dalgaların sadece dalga boyu 380 nm ile 780 nm arasında değişen ve renk olarak tanımlanan kısmını görebilir.

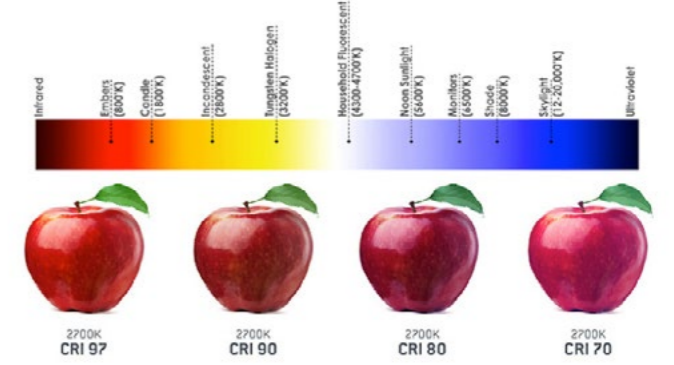

## Renk

Farklı dalga boylarındaki ışınların insan beyninde yaptığı çağrışımlardır. Bir ışık demetinin rengini tayfsal özellikleri belirler.

## ELECTROMAGNETIC SPECTRUM

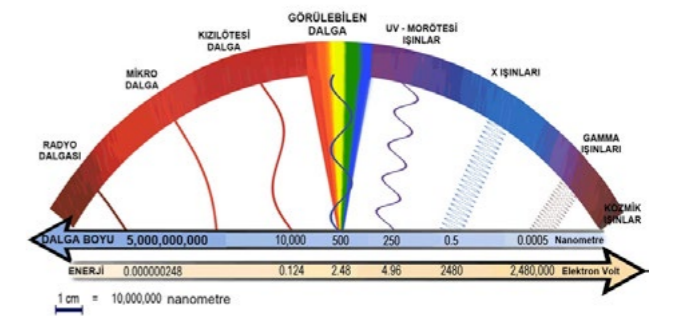

## Konik Diagram

Aydınlatma ürününden çıkan ışık akısının baz alınan belli yükseklikler için ne kadarlık ışık şiddeti (lx) oluşturacağı belirtilmektedir. Aşağıdaki tabloda 90 Derece Açılı ile kullanılan armatürlerin farklı yüksekliklerde zemine vurma dağılımı gösterilmektedir. Hesaplama sonucu oluşturulan diagramda ortam koşulları hesaplamalara dahil edilmemiştir.

Distance (m)	Cone Diameter (m)	E <sub>0</sub> <sup>(1)</sup> E <sub>1</sub> (C)	2018 174
0.5	1.40	E <sub>0</sub> <sup>(1)</sup> E <sub>1</sub> (C)	56.2° 43
1.0	2.80	E <sub>0</sub> <sup>(1)</sup> E <sub>1</sub> (C)	56.2° 19
1.5	4.20	E <sub>0</sub> <sup>(1)</sup> E <sub>1</sub> (C)	56.2° 11
2.0	5.60	E <sub>0</sub> <sup>(1)</sup> E <sub>1</sub> (C)	56.2° 7
2.5	7.00	E <sub>0</sub> <sup>(1)</sup> E <sub>1</sub> (C)	56.2° 5
3.0	8.40	E <sub>0</sub> <sup>(1)</sup> E <sub>1</sub> (C)	56.2° 5

Distance (m) Cone Diameter (m)  
C0 - C180 (Half value angle: 112.4°)

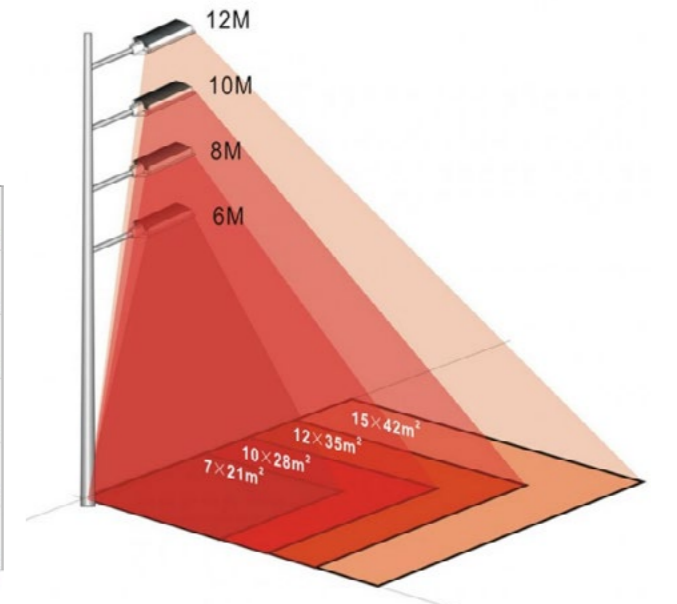



### Types of Light Lamps

The lighting lamps in use today are shown below table. Mercury vapor lamps were used intensively in lighting systems. As you may see from following table, technology is always improving therefore long life energy-saving and higher lighting efficiency products are being preferred.

Types of Lamps	Light efficiency (lm/W)	Lifetime (hour)
Incandescent Lamps	8 - 16	1000
Halojen Lamps (Tungsten)	12 - 26	2.000 - 4.000
Floresan Lamps	45 - 100	6.000 - 15.000
High-pressure	36 - 60	6.000 - 8.000
Mercury-vapor Lamps	71 - 98	5.600 - 6.500
Induction	68 - 72	5.800 - 6.200
High Pressure Sodium Lamps	66 - 142	10.000 - 15.000
Low Pressure Sodium Lamps	100 - 198	11.500 - 20.000
LED	80 - 165	50.000 - 100.000

### Luminous Flux (LM)

The amount of light (energy) as seen by the human eye that is given off by the light bulb described as luminous flux. It is designated by the symbol F and is expressed in lumens and total luminous flux is described as sum amount of the luminous flux that emitted by a light source and spread into space sundry parts. Its unit of light energy. In other words, total outcome from a light source stated by Lumen. More lumens means it's a brighter light. (1lm=0,00146 W)

### Luminous Level (Lux)

Illuminance level is the quantity of total luminous flux falling on unit area of a surface and It is designated by the symbol E. Its unit is lux. One lux equals to a candle light.

### Colour Temperature (K)

Defines the color of light of a light source which emits white radiation. Old type incandescent lamps have usually 2500 K light colour. Besides that 2700 K is expressed yellow light, 3000 K is daylight(or warm white), 4000 K is pure white, 5000-6000 K is cool white.

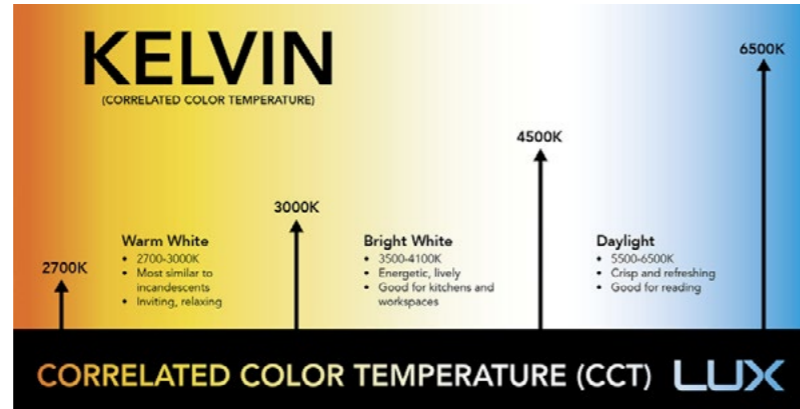

### Color Rendering Index (CRI)

Colour rendering index measures the objects appear under a given light source. A light with a high CRI rating will allow an object's colours to be appeared more natural. Value of the CRI is ranging from 0 (very poor color rendition) to 100 (nearly perfect color rendition). Light sources with CPI over 80 are considered excellent for colour recognition.



### Luminous Intensity (Cd)

Concentration of light emitted in a specific direction per unit time. Unit is the Candela and shown 'cd'. 1 cd luminous intensity is equal to 1 lm luminous flux emitted in 1 steradian space angle.

### Light

According to wave theory, light is the way electromagnetic radiation energy that are seen to human eye. It has a specific radiation speed, frequency and wavelength. Only electromagnetic wavelengths between 380 nm and 780 nm and defined as colours are visible to humen eye.

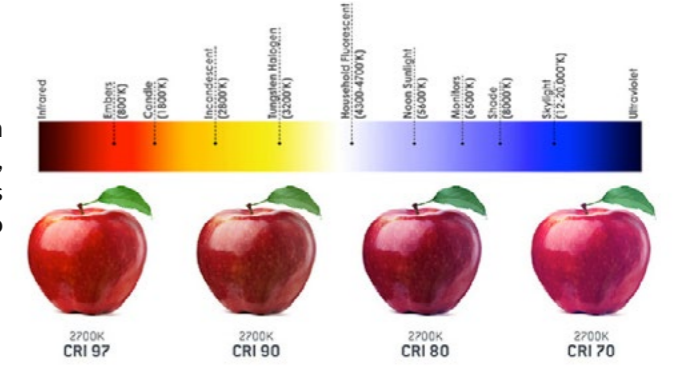

### Colour

Associations of different wavelength light beam in the human brain defined as colour. The colour of a light beam is determined by spectrum.

### ELECTROMAGNETİK SPECTRUM

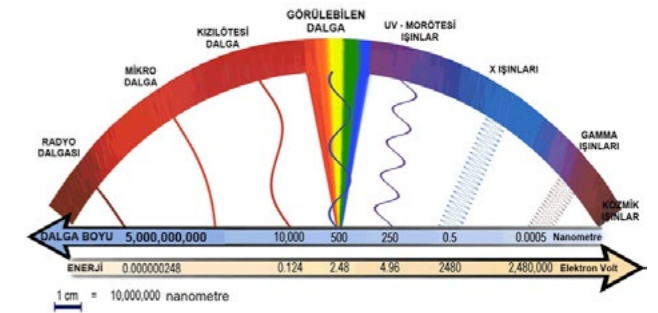

### Conic Diagram

It specifies how much luminous intensity (lx) is to be produced based on certain heights by light output of lighting products. The following table shows the distribution of light hitting at different heights of Luminaires with 90 Degree Angle. Environmental conditions are not included in calculations of diagram.

0,5	1,40	E(0°) E(CR)	2048 174
1,0	2,99	E(0°) E(CR)	524 43
1,5	4,48	E(0°) E(CR)	354 19
2,0	5,98	E(0°) E(CR)	266 11
2,5	7,47	E(0°) E(CR)	204 7
3,0	8,96	E(0°) E(CR)	156 5

Distance [m]    Cone Diameter [m]    Illuminance [lx]

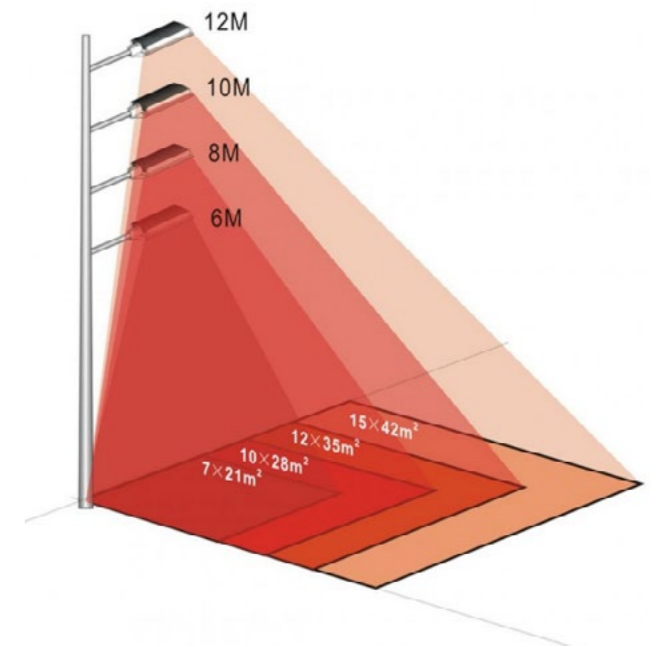

CO - C180 (Half value angle: 112.4°)









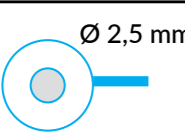
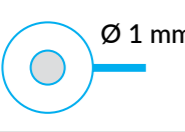
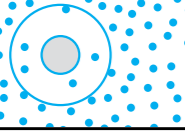
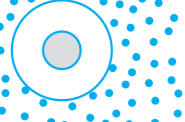

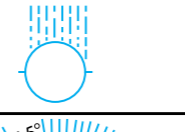

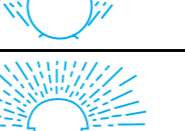
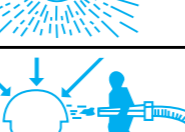
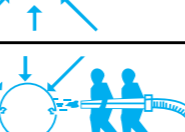
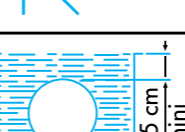
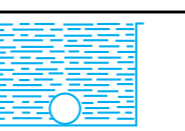

















## IP Koruma Sınıfı / Ingress Protection Rating (IP)

IP Kodu armatürlerin katı ve sıvı cisimlere karşı koruma göstergesidir. IP Koruma sınıfları iki rakamla gösterilir. Birinci rakam katı cisimlere karşı ikinci rakam ise sıvılara karşı korumayı gösterir. Koruması yüksek aydınlatma armatürlerinin iç kesimleri daha temiz olacağından armatürlerin reflektörleri daha iyi bir verim sağlayacaktır.

IP Code is a protection indicator of Luminaires against solid and liquid substances. IP Protection classes are indicated by two digits. The first number is against solid objects and the second number shows protection against liquids. High protected luminaires reflectors will provide better efficiency because of their cleaner inner parts.

Birinci Rakam / First Number Katı cisimlere karşı koruma / Degree of Protection (Solids)		
IP	Testler	
0	 Ø 50 mm	Korumasız Non Protection
1	 Ø 50 mm	50 mm <sup>2</sup> 'den büyük boyutlardaki katı cisimlerden koruma Protection against large foreign bodies (diameter<50mm <sup>2</sup> )
2	 Ø 12,5 mm	12.5 mm <sup>2</sup> den büyük boyuttaki katı cisimlerden koruma Protection against medium foreign bodies (diameter<12.5mm <sup>2</sup> )
3	 Ø 2,5 mm	2.5 mm <sup>2</sup> den büyük boyuttaki katı cisimlerden koruma Protection against small foreign bodies (diameter<2.5mm <sup>2</sup> )
4	 Ø 1 mm	1 mm <sup>2</sup> den büyük boyuttaki katı cisimlerden koruma Protection against small foreign bodies (diameter<1mm <sup>2</sup> )
5		Tozlardan koruma Dust Protected
6		Tozlara karşı tamamı ile koruma Dust-tight

İkinci Rakam / Second Number Sıvı cisimlere karşı koruma / Degree of Protection (Water)		
IP	Testler	
0		Korumasız Non Protection
1		Düşey olarak akan su damlalarından koruma Protection against vertical water drops
2		Düşey'le 15° lik açı yapan su damlalarından koruma Protection against inclined water drops (15° from vertical)
3		Düşey'le 60° lik açı yapan su damlalarından koruma Protection against splash water drops (60° from vertical)
4		Her yönden gelen su damlalarından koruma Protection against splash water from all directions
5		Her yönden hortum marpuçundan püsküren su fişkırtmalarından koruma Protection against water jets from any angle
6		Her yönden, deniz dalgalarına benzer şekilde çarpan suların etkisine karşı tam koruma Protection against temporary flooding
7		Suya gömülme durumunun etkilerinden koruma Protection against water submersion to 1m for 30 min
8		Belirlenmemiş koşullar altında uzun sürelerde suya gömülme durumunun etkilerinden koruma Protection against high pressure water and submersion for an indefinite time

Sembol Symbol	Açıklama Explanation	Sembol Symbol	Açıklama Explanation
	Türk Standartlarına Uygunluk Belgesi Turkish Standard Compliance Certificate		Yanıcı Yüzeyle Monte Edilebilir Can be Mounted to flammable surfaces
	Kalite Sistem Belgesi Quality System Certification		I.Sınıf Gövde Koruma Topraklanmış 1.Class of protection. The body is grounded.
	ISO 14001 Kalite Sistem Belgesi ISO 14001 Quality System Certification		Geri Dönüşüme Uygundur Suitable for recyCeiling
	OHSAS 18001 Kalite Sistem Belgesi OHSAS 18001 Quality System Certification		Yetkili Personel Tarafından Müdahale Edilmeli Must be intervened by authorized personnel
	ROHS Uygunluk Sertifikası RoHS Compliance Certificate		IP20 Koruma Sınıfı Protection Class IP 20
	CE Deklarasyon Belgesi CE Declaration Document		IP65 Koruma Sınıfı Protection Class IP 65
	EAC Gümrük Birliği Belgesi EAC Custom Union Certificate		Eğitim Kurumları Educational Institutions
	Ukrayna Standartlarına Uygunluk Belgesi Ukrainian Standards Compliance Certificate		Yaşam Alanı Living Space
	Rusya Standartlarına Uygunluk Belgesi Russian Standards Compliance Certificate		Endüstriyel Tesisler Industrial Plants
	Avrupa Standartlarına Uygunluk Belgesi European Standards Compliance Certificate		Alışveriş Merkezleri Shopping Malls
	Enerji Tasarrufu Energy Saving		Sağlık Kuruluşları Health Institutions
	Alev İletmeyen Ham madde Halogen Free		Dış Mekan Outdoor
	Şebeke Gerilimi (220V) ile Çalışır Works with mains voltage (220V)		

## MİNİMUM AYDINLIK DÜZEYLER



	LUX		LUX
KONUTLAR		X rayonu servisi (ayarlanabilir aydınlatma)	80
Oturma Odaları	500	Dişle ilgili servis büro için (genel aydınlatma)	250
Mutfaklar	250	Hasta koltuğu	5000
Yatak Odaları	250	WC	50
Giriş holü merdivenler çatı karı ambar garajlar	250	Doğum Servisi	
<b>BÜROLAR</b>		Annelerin yatakları	5000
Resim büroları kadastro harita	2500	Çalışma salonu (genel aydınlatma)	250
Projeler teknik resim mimari	750	Çocukların odası	100
Dekoratif resim ve krokiler	500	Bekleme salonları	100
Muhasebe ile ilgili aygıtlar	500	Hastaneler için özel odalar (genel aydınlatma)	50
Hesaplamalar	400	Yatak aydınlatması	200
Daktilo odası	500	<b>HOTEL VE RESTORANTLAR</b>	
Belgelerin bulunduğu salon	100	Banyolar	100
Yönetim büroları	250	Aynalar (ek aydınlatma)	200
Bekleme salonları	150	Hol ve merdivenler	50
Konferans salonları	200	Mutfaklar	250
Kantinler	150	Odalar	150
<b>OKULLAR</b>		Yatak ucu aydınlatması	150
Yuvalar anaokulları	100	Büro masası	200
Sınıflar	200	Tuvalet masası	250
Jimnastik salonları	100	Önemli Mekanlar	
İlkokullar sınıflar	250	Konferans salonları	75
Deney sınıfları	300	Platform	200
Toplantı salonu	150	Sergileme ve tanıtımlar	150
Jimnastik salonu	150	Salonlar	50
Meslek Okulları	400	Restorantlar	75
İlk ve ortaokul düzeyindeki teknik okullar		Barlar	75
Sınıflar	250	<b>ÇAMAŞIRHANE</b>	
Resim sınıfları	400	Yıkama yeri	150
Atölyeler	250	Onarım sayım işaret	200
<b>HASTANELER</b>		Özel parça onarımı	400
Doktor Odaları	100	<b>CAM FABRİKASI</b>	
Çalışma masaları	400	Karıştırma	150
Genel aydınlatma	150	Fırnlama.soğutma	150
Dispanser masaları	400	Mak. İşleme salonu	150
Yedek odalar	150	Ölçüye göre kesme	200
Toplantı odası	100	Parlatma	200
Laboratuvarlar		Pahlandırma	400
Araştırma salonları	250	Gravür işleme	500
Çalışma masaları	400	Kontrol	750
Tanı ve terapi odaları (genel aydınlatma)	250	<b>ÇELİK FABRİKASI</b>	
Tanı masası	500	Haddehane	150
Operasyon odası (genel aydınlatma)	500	Boru çubuk tel im.	200
Operasyon masası	20000	Galvanizasyon	200
Sterilizasyon odası	400	Makine dairesi	150

## MINIMUM BRIGHTNESS LEVELS



	LUX		LUX
Kalite kontrol	400	Denetleme ve lekelerin çıkarılması	1500
<b>YÜKSEK FIRIN</b>		Ütüleme	
Kömür ve cevher deposu	50	Makine ile ya da elle	500
Yükleme	100	Katlama ve üzerinde değişiklikler yapma	750
Kontrol kapak ları	150	<b>TEKSTİL SANAYİ</b>	
Fırın kapakları bakımı	100	Pamuk	
Demir kütük deposu	50	Pamukların açılıp karıştırılması ayrılması	100
Çelik fabrikası	150	Tarama makaradan geçirme iplik durumuna getirme	200
<b>KERESTE FABRİKASI</b>		Haddeden geçirme	400
Makine ile ilk kesme	150	Denetleme	
Y. Hassas işleme	200	Sabit parçalar	400
Hassas işleme	400	Hareketli (hızlı) parçalar	1500
<b>KAYNAK</b>		İpek ve sentetik telli kumaşlar	100
Genel aydınlatma	250	Koyu renkli ipliklerle çalışma	750
Hassas ark kaynağı	2500	Dokuma	400
<b>DÖKÜMHANE</b>		Yün	
Maça imali (Hassas)	350	Yünlerin açılıp karıştırılması ayrılması	100
Maça imali (Kaba)	200	Denetleme	400
Döküm salonu	200	Tarama, çekip uzatma, çirileme mekik geçirme	200
Temizleme parit	200	Haddeden geçirme	
Kontrol		Beyaz	200
<b>AYAKKABI FABRİKASI</b>		Renkli	400
Kesim ve seçme	1000	Dokuma	
Model hazırlanması	1000	Beyaz	400
İnce kesim	1000	Renkli	750
Kauçuk hazırlama	125	<b>SERAMİK SANAYİ</b>	
Vernikleme	200	Öğütme, filtreleme ve kurutma kompanzasyonu	100
Volkanize kesme	200	Formlama, bitirme ve temizleme	150
Taban hazırlama	400	Reklendirme ve parlatma	400
<b>MAKİNE ATÖLYELERİ</b>		Reklendirme ve parlatma (İnce detaylar)	750
Kaba işleme	250	<b>MAĞAZALAR</b>	
İnce işleme ve parlatma	400	Vitrinler	1000
Çok ince işleme	2500	Büyük kentlerdeki satın alma merkezleri (Genel aydınlatma)	1000
<b>GIYİM SANAYİ</b>		Spotla ek aydınlatma	5000
Kumaşların denetimi		Diğer yerlerde (Genel aydınlatma)	500
Açık renkli kumaşlar	1500	Spotla ek aydınlatma	2500
Koyu renkli kumaşlar	2500	Mağaza iç mekanı	
Kesim ve Ütüleme	750	Büyük mağazalar	1000
Açık renkli kumaşlar	500	Büyük kentlerin ticaret merkezleri	1000
Koyu renkli kumaşlar	1000	Diğer yerler	500
Dikme ve Çeşitlendirme	750	Genel mağazalar (Az uğranan bölümler)	250
Açık renkli kumaşlar	750	Fabrika mağazaları (Çok uğranılan bölümler)	300
Koyu renkli kumaşlar	1500	Büyük parçaların yeri	100
<b>BOYAMA</b>		Küçük parçaların yeri	200
Belirginleştirme ayırma yıkama temizleme	200	Çok küçük parçaların yeri	300

## MİNİMUM AYDINLIK DÜZEYLER



	LUX		LUX
Müzeler	150	Park yerleri	50
Tablolar (bölgesel aydınlatma)	750	Sergileme salonları	400
Heykel ve diğer nesneler	400	OTOMOBİL FABRİKALARI	
TİYATROLAR		Şasilerin toplanması, birleştirilmesi	200
Giriş ve fuaye	200	Şasilerin dizilimi	400
Salon	50	Döşemenin yapımı, çeşitli parçaların toplanıp birleştirilmesi	300
Orkestra yeri	100	Genel birleştirme	400
İbadethane	80	Bitirme ve denetleme	750
SİNEMALAR		Boya Fabrikaları	150
Giriş ve kasa	200	MATBAA	
Fuaye	50	Matris imali	400
Salon	100	Harflerin hazırlanması	200
SPOR SALONLARI		Renk ayırımı	
Stad	200	Baskı yeri	250
Futbol alanı	100	Mizampaj masası	500
Antreman alanı	25	KAĞIT FABRİKASI	
Tenis kortu	250	Karıştırma odası	150
Paten sahası	15	Kağıt makineleri	200
Paten sahası/yarışmalar için)	40	Kesme dek.	200
EKMEK FIRINLARI		Kontrol laboratuvarı	400
Karışım salonları	200	KİMYA SANAYİ	
Hamur reyonları	125	Elle çalıştırılan fırınlar sabit kurutucular ve kristalizasyon kapları	150
Fermantasyon salonu	125	Otomatik fırınlar buharlı kazanlar damıtma kolonları	150
Hazırlama salonu	200	Koyulaştırma kazanları nitasyon elektroliz	150
Fırınların bulunduğu salon	150	UÇAK ENDÜSTRİ	
Süsleme ve soğutma	250	Kaynak civata ve taşlama	250
Ambalaj salonu	150	Boya kabini	400
DEĞİRMENLER		Parçaların işlenmesi	400
Karıştırma tem.	200	İnce kaynak	250
Ambalaj salonu	100	Montaj	400
Mamul kontrolü	400	İşin tamamlanması	400
Silo temizliği	100	Kanat ve parça montajı	400
TREN İSTASYONLARI		UÇAK HANGARI	
Bekleme salonları	100	Bakım yeri	250
Bilet alma ve büroların bulunduğu yerler	400	Motor bakımı	400
Serinleme ve dinlenme salonları	150	SABUN ENDÜSTRİSİ	
Bavul emanet yeri	200	Toz sabun imali	150
Peronlar	100	Markalama paket	150
WC	100	Kalıplama ambalaj	250
GARAJLAR		TÜTÜN FABRİKASI	
Atölye	250	Kurutma	150
Tezgahtar	500	Ön hazırlama	150
Yağlama bölümleri	150	Kontrol ve seçme	200
Yağlama yerleri	250	Sigara makineleri	400

## MINIMUM BRIGHTNESS LEVELS



	LUX		LUX
KONSERVE ENDÜSTRİSİ		Trafiği önemli olmayan ticari cadde	7.5
Yiyecek ayıklama	200	Trafiği olan konutlu cadde	7.5
Yıkama temizleme	200	Trafiği olmayan konutlu cadde	5
Renklerin ayrılması	300	Önemli bir çıkmaz sokak	15
Gerekli parçaları ayırma	300	Dağıtım garları	10
Kutulara koyma mek.	300	Bağımlı İşletmeler	
Kutulara koyma elle	200	Taşıma bölgeleri	20
Boş kutuların kontrolü	100	Stoklama(doldurma ve boşaltım)	20
Kutu kaynağı	300	Gözetleme aydınlatması	5
Paketleme-ambalaj	150	Girişler	50
SÜT ENDÜSTRİSİ		Yükleme platformları	50
Sterilizasyon odası	150	Trafiği olan ticari cadde	10
Pastorizasyon odası	150		
Kalıpların yıkanması	150		
Soğuk odalar	150		
Krema ayrılması	150		
Şişelerin seçimi	200		
Şişe yıkama makinası	400		
Doldurma salonu	125		
Laboratuvar	400		
ŞEKER ENDÜSTRİSİ			
Kesme karıştırma	200		
Temizleme.arıtma	400		
Renk kontrolü	750		
Depolama	50		
ELEKTRİK SANTRALİ			
Yanma hav. haz. Tesis	50		
Akümülatör dairesi	100		
Kazan bakım atölyesi	100		
Kazanların ön kısmı	50		
Kazana yakıt yük.	100		
DIŞ AYDINLATMA			
Genel halka açık aydınlatma			
Yerleşim bölgesinin dışı.ana trafik arteri	20		
Belediyeler arası anayol	15		
Belediyeler arası yol	10		
Yerleşim Bölgesinin İçi	30		
Kent içindeki hızlı doluşım yolları	20		
Yakın yollar	20		
Tüneller(gün boyunca aydınlatma)	100		
Giriş aydınlatması	1000		
Gece aydınlatması	30		
Sanayi bölgesindeki liman ya da sokaklar	10		
Kıyı tevsiye havuzu ya da köprü	10		

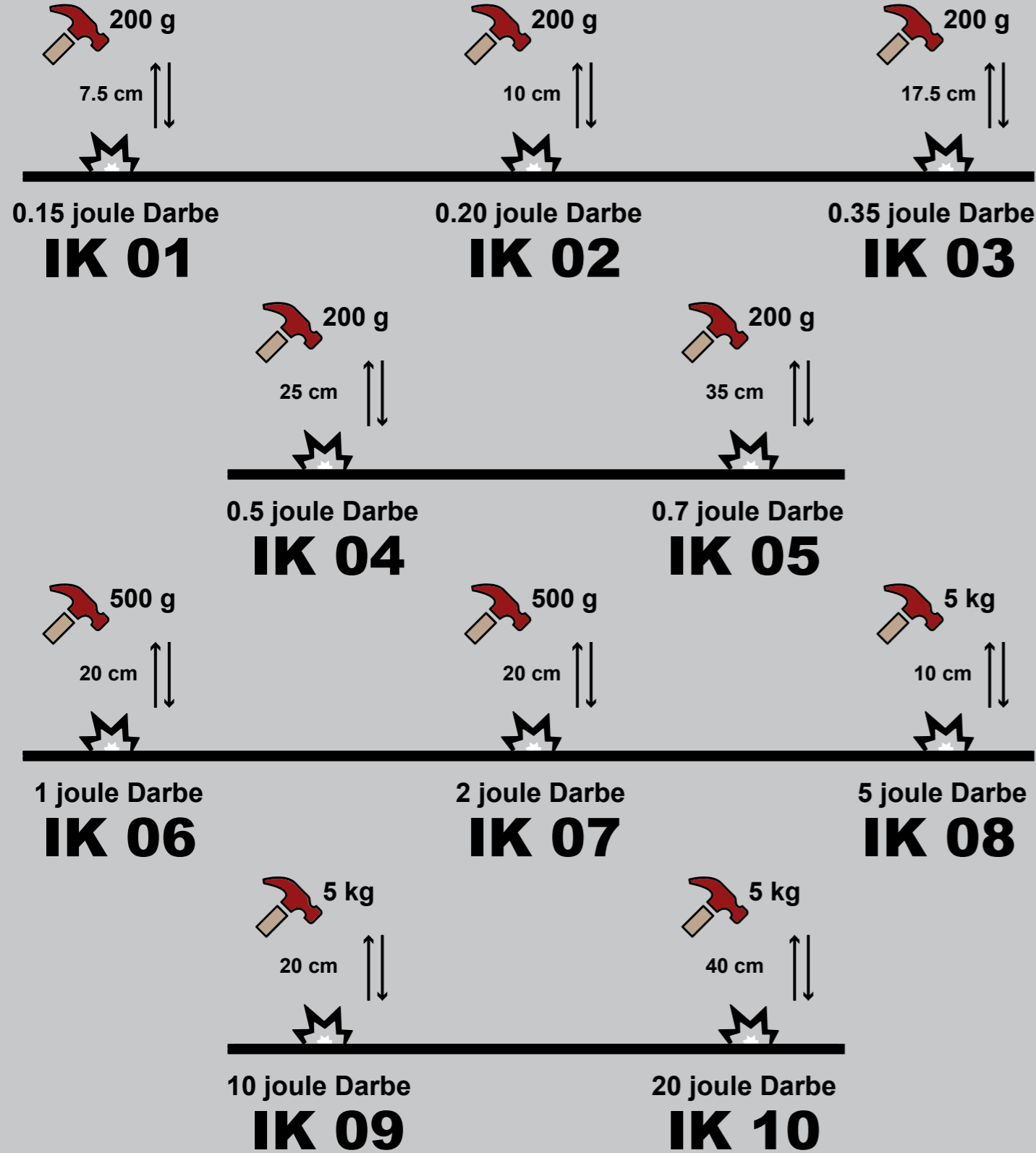

**İK Koruma Sınıfı Nedir?**

İK koruma sınıfı, elektrikli ve elektronik cihazların dış etkilere karşı dayanıklılığını belirten uluslararası bir standarttır. Bu sınıflandırma, özellikle mekanik darbelerle karşı koruma seviyesini tanımlamak için kullanılır ve IEC 62262 standardına dayanır. İK derecelendirmesi, genellikle endüstriyel ekipmanlar, dış ortamda kullanılan cihazlar, güvenlik kameraları, aydınlatma armatürleri ve benzeri ürünlerin fiziksel dayanıklılığını belirlemek için önemli bir kriterdir.

**İK Derecelendirme Standardı**

İK koruma sınıfları, cihazın darbelerle karşı gösterdiği direnci ifade eder ve genellikle "İK" harfleri ile başlayıp iki rakamdan oluşan bir değer ile belirtilir (örneğin, IK08, IK10). IEC 62262 standardına göre, her bir İK derecesi belirli bir darbe enerjisi seviyesi ile test edilir. Bu testler sırasında farklı büyüklükteki çekiç veya benzeri darbeli test cihazları kullanılarak ürünlerin dayanıklılığı ölçülür.

**İK Derecesi Nasıl Belirlenir?**

İK derecelendirme testi, belirli yüksekliklerden farklı ağırlıklarda düşen nesnelere yapılır. Test sırasında:

- Ürün, belirlenen bir yükseklikten serbest bırakılan bir çekiçle darbeye maruz bırakılır.
- Darbe noktaları önceden belirlenir ve test sırasında farklı açılardan uygulanır.
- Test sonucunda ürünün hasar durumu incelenir ve belirli bir İK derecesi atanır.

**İK Koruma Sınıfının Önemi**

İK koruma sınıfı, özellikle dış mekanlarda veya zorlu endüstriyel ortamlarda kullanılan cihazlar için büyük önem taşır. Yüksek İK derecesine sahip ürünler, darbelerle karşı daha dayanıklı olup uzun ömürlü bir kullanım sağlar. Özellikle güvenlik kameraları, dış mekan aydınlatmaları ve kamuya açık alanlardaki ekipmanlarda İK dereceleri büyük bir belirleyici faktördür.

**İK Derecesi ile IP Koruma Sınıfı Arasındaki Fark**

İK koruma sınıfı, fiziksel darbelerle karşı koruma seviyesini ifade ederken, IP (Ingress Protection) koruma sınıfı, suya ve toza karşı koruma seviyesini belirtir. Örneğin, bir cihaz IK10 ve IP67 derecesine sahip olabilir. Bu, cihazın hem güçlü darbelerle hem de su ve toz girişine karşı dayanıklı olduğu anlamına gelir.

**What is IK Protection Class?**

The IK protection class is an international standard that determines the durability of electrical and electronic devices against external influences. This classification is specifically used to define the level of protection against mechanical impacts and is based on the IEC 62262 standard. IK rating is an important criterion for determining the physical durability of industrial equipment, outdoor devices, security cameras, lighting fixtures, and similar products.

**IK Rating Standard**

IK protection classes indicate the resistance of a device to impacts and are usually denoted by the letters "IK" followed by a two-digit value (e.g., IK08, IK10). According to the IEC 62262 standard, each IK rating is tested at a specific impact energy level. During these tests, various sizes of hammers or similar impact test devices are used to measure the durability of the products.

**How is the IK Rating Determined?**

The IK rating test is conducted by dropping objects of different weights from specific heights. During the test:

- The product is subjected to impact by a hammer released from a predetermined height.
- Impact points are determined in advance and applied from different angles during the test.
- After the test, the product's damage status is examined, and a specific IK rating is assigned.

**Importance of the IK Protection Class**

The IK protection class is crucial for devices used in outdoor environments or harsh industrial conditions. Products with a high IK rating are more resistant to impacts and offer a longer lifespan. IK ratings are a significant factor, especially in security cameras, outdoor lighting, and public area equipment.

**Difference Between IK Rating and IP Protection Class**

While the IK protection class defines the level of protection against physical impacts, the IP (Ingress Protection) protection class indicates the level of protection against water and dust. For example, a device with an IK10 and IP67 rating is resistant to both strong impacts and water and dust ingress.





ETANJ GLOP & ARMATÜRLER



SİGORTA KUTUSU



30X30 & 60X60 PANEL



ISO 9001:2015



ISO 14001:2015



ISO 45001:2018

